

SIEMENS

SIEMENS

Wine storage compartment

CI18WP03/CI24WP03

[en] Instruction manual



Register your product on My Siemens and discover exclusive services and offers.

siemens-home.bsh-group.com/welcome

The future moving in.

Siemens Home Appliances

en Table of contents

Safety instructions	3	Alarm	11
About these instructions	3	Door alarm	11
Risk of explosion	3	Home Connect	12
Risk of electric shock	3	Setting up Home Connect	12
Fire hazard/Danger due to refrigerants	3	Connecting the refrigerator to the Home Connect app	12
Fire hazard	3	Installing updates for the Home Connect software	13
Avoiding placing children and vulnerable people at risk	3	Customer Service access	13
Damage to property	4	Restoring settings	13
Weight	4	Switch on or off the connection to the home WLAN network (Wi-Fi)	13
Intended use	5	Information on data protection	13
Green living	5	Declaration of Conformity	13
Packaging	5	Wine storage compartment	14
Old appliances	5	Loading bottles	14
Installation and connection	6	Tips for storing wine	14
Scope of supply	6	Drinking temperatures	15
Technical specifications	6	Cleaning	15
Installing the appliance	6	Cleaning the display	15
Built-in cut-out	6	Cleaning the appliance interior	15
Side-by-side installation	6	Cleaning the equipment	15
Tips for saving energy	7	Care instructions for stainless steel surfaces	15
Before using the appliance for the first time	8	Noises	16
Electrical connection	8	Normal noises	16
Getting to know your appliance	9	Preventing noises	16
Appliance	9	Lighting	16
Controls	9	What to do in the event of a fault	17
Features	10	Appliance	17
Operating the appliance	11	Customer Service, product / production number and technical data	18
Switching on the appliance	11	Appliance self-test	18
Switching off and disconnecting the appliance	11	Obtaining advice and ordering repairs if a fault occurs	18
Setting the temperature	11		
Humidity	11		
Sabbath mode	11		

Safety instructions

This appliance complies with the relevant safety regulations for electrical appliances and is fitted with noise suppression.

The refrigeration circuit has been checked for leaks.

About these instructions

- Read and follow the instructions for installation and use. They contain important information on how to install, use and maintain the appliance.
- The manufacturer is not liable if you disregard the notifications and warnings in the operating and installation instructions.
- Retain all documents for subsequent use or for the next owner.

Risk of explosion

- Never use electric devices inside the appliance (e.g. heaters or electric ice makers).
- Do not store products which contain flammable propellant (e.g. spray cans) or explosive substances in the appliance.

Risk of electric shock

Improper installations and repairs may put the user at considerable risk.

- When installing the appliance, ensure that the mains cable is not trapped or damaged.
- If the mains cable is damaged: immediately disconnect the appliance from the electricity supply.
- Do not use multi-outlet power strips, extension leads or adapters.
- Have the appliance repaired by the manufacturer, Customer Service or a similarly qualified person only.
- Use original parts supplied by the manufacturer only.

The manufacturer guarantees that these parts satisfy the safety requirements.



Fire hazard/Danger due to refrigerants

The tubes of the refrigeration circuit convey a small quantity of an environmentally friendly but flammable refrigerant (R600a). It does not damage the ozone layer and does not contribute to the greenhouse effect. If refrigerant escapes, it may injure your eyes or ignite.

- Do not damage the tubes.

If the tubes are damaged:

- Keep naked flames and ignition sources away from the appliance.
- Ventilate the room.
- Switch off the appliance and pull out the mains plug.
- Please contact Customer Service.



Fire hazard

Portable multi-outlet power strips or power supplies may overheat, causing a fire. Never leave portable multi-outlet power strips or portable power supplies behind the appliance.

Avoiding placing children and vulnerable people at risk

At risk here are:

- Children,
- People with limited physical, mental or sensory abilities,
- People who have inadequate knowledge concerning safe operation of the appliance.

Measures:

- Ensure that children and vulnerable people have understood the hazards.
- A person responsible for safety must supervise or instruct children and vulnerable people who are using the appliance.
- Only children aged 8 years and above may use the appliance.
- Supervise children who are cleaning and maintaining the appliance.
- Never allow children to play with the appliance.

Risk of suffocation

- If the appliance features a lock: keep the key out of the reach of children.
- Keep children away from the packaging and its parts.

Damage to property

To prevent damage to property:

- Do not stand or support yourself on the base, runners or doors.
- Keep plastic parts and door seals free of oil and grease.
- Pull on the mains plug – not the power cord.

Weight

The appliance is very heavy. The appliance should always be transported and set up by at least 2 persons.

→ *"Installation and connection" on page 6*

Intended use

Use this appliance

- only for storing wine.
- Only in the home and in the home environment.
- Only according to this user manual.

This appliance is intended for use up to a maximum height of 2000 metres above sea level.

Green living

Packaging

All materials are environmentally safe and recyclable:

- Dispose of packaging in an environmentally friendly manner.
- Please ask your dealer or inquire at your local authority about current means of disposal.

Old appliances

Valuable raw materials can be reclaimed by recycling old appliances.

Warning – Children may become locked in the appliance and suffocate!

- Leave shelves and containers in the appliance to prevent children from climbing in.
- Keep children away from the redundant appliance.

Caution!

Refrigerant and harmful gases may escape.

Do not damage the tubes of the refrigerant circuit or the insulation.

1. Pull out the mains plug.
2. Cut through the power cable.
3. Have the appliance disposed of properly.



This appliance is labelled in accordance with European Directive 2012/19/EU on waste electrical and electronic equipment (WEEE).

This Directive provides an EU-wide framework for returning and recycling old appliances.



Installation and connection

Scope of supply

After unpacking all parts, check for any damage in transit.

If you have any complaints, contact the dealer from whom you purchased the appliance or our Customer Service.

The delivery consists of the following parts:

- Built-in appliance
- Interior fittings (depending on model)
- Installation material
- User manual
- Installation instructions
- Customer service booklet
- Warranty enclosure
- Information on the energy consumption and noises

Technical specifications

Refrigerant, cubic capacity and further technical specifications can be found on the rating plate.

→ "Getting to know your appliance" on page 9

Installing the appliance

Installation location

The more refrigerant an appliance contains, the larger the room in which the appliance is situated must be. In rooms which are too small, leaking refrigerant can form a flammable gas-air mixture.

At least 1 m³ of room space is required per 8 g of refrigerant. The amount of refrigerant in your appliance is indicated on the rating plate inside the appliance.

→ "Getting to know your appliance" on page 9

The weight of the appliance may be up to 460 kg depending on the model. The base must be sufficiently stable, and should not give. If necessary, reinforce the floor.

Permitted room temperature

The permitted room temperature depends on the climate class of the appliance.

Information on the climate class can be found on the rating plate.

→ "Getting to know your appliance" on page 9

Climate class	Permitted room temperature
SN	+10°C ... 32°C
N	+16°C ... 32°C
ST	+16°C ... 38°C
T	+16°C ... 43°C

The appliance is fully functional within the permitted room temperature.

If an appliance with climate class SN is operated at colder room temperatures, the appliance will not be damaged up to a room temperature of +5°C.

Built-in cut-out

The cut-out must fulfil these criteria:

- Anti-tilt bracket fitted
- Cut-out depth min. 610 mm, for flush installation 635 mm
- Rectangular
- Sturdy – the side panels and the top must be min. 16 mm thick and securely attached to the floor or wall
- Depth of shortened side panels: min. 100 mm

Side-by-side installation

Observe the specifications in the installation instructions for a side-by-side installation.

If a partition wall is required between the appliances, it must be at least 16 mm wide.

Tips for saving energy

If you follow the instructions below, your appliance will use less power.

Note:

The arrangement of the features does not affect the energy consumption of the appliance.

Installing the appliance	
Keep the appliance out of direct sunlight.	The appliance needs to cool less frequently at low ambient temperatures and therefore consumes less power.
Install the appliance as far away as possible from heating elements, cookers and other heat sources: At least 1 1/4" (3 cm) from electric or gas cookers. At least 1 1 3/4" (30 cm) from oil or solid-fuel cookers.	
Select an installation location with a room temperature of approx. 20°C.	
Do not cover or block the ventilation openings.	If the warm air can escape, the appliance needs to cool less frequently and therefore consumes less power.
Ventilate the room daily.	

Using the appliance	
Open the appliance door only briefly.	The air in the appliance does not warm up so intensely. The appliance must cool less frequently and therefore consumes less power.
Transport cooled wine in a cool bag and place in the appliance quickly.	
Always leave a space between the bottles and the back wall.	The air can circulate, and the temperature will remain constant. The appliance must cool less frequently and therefore consumes less power.
Do not cover or block the ventilation openings.	The appliance consumes less power if the warm air can escape freely.
Vacuum the ventilation openings once a year.	

Before using the appliance for the first time

1. Remove information material, adhesive tape and protective film.
2. Clean the appliance.

Electrical connection

Caution!

Do not connect the appliance to electronic energy saver plugs.

Note:

You can connect the appliance to mains-controlled and sine-controlled inverters.

Mains-controlled inverters are used for photovoltaic systems which are directly connected to the national grid. Sine-controlled inverters must be used for isolated applications. Isolated applications, e.g. on ships or in mountain lodges, which are not directly connected to the national grid.

1. After installing the appliance, wait at least 1 hour before connecting it to avoid damaging the compressor.
2. Connect the appliance to a correctly installed socket.

The socket must comply with the following data:

Socket with 220 V ... 240 V

Protective conductor 50 Hz

Fuse 10 A ... 16 A

Outside Europe: Check whether the indicated current type of the appliance corresponds with the values of your power supply. The appliance specifications are specified on the rating plate.

→ *"Getting to know your appliance" on page 9*

3. Connect the appliance to a socket near the appliance.

The socket must also be freely accessible after installation of the appliance.

Warning

Risk of electric shock!





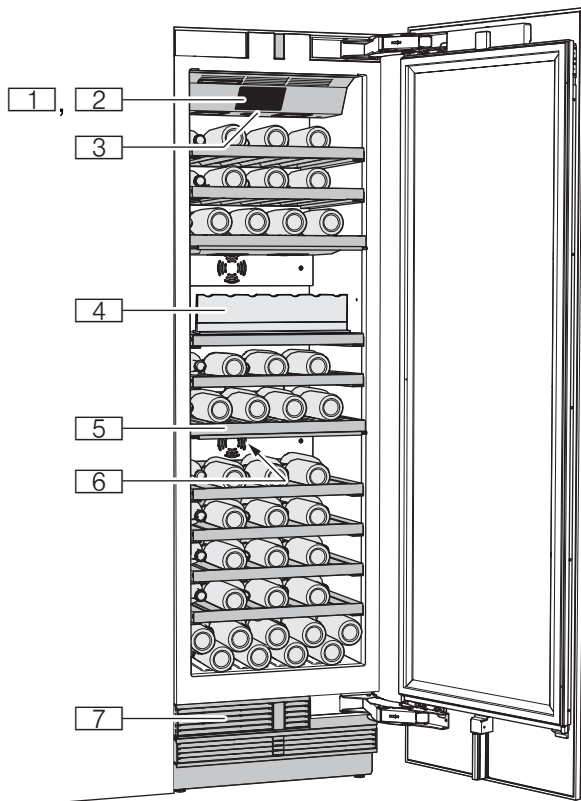

If the length of the mains cable is insufficient, do NOT use multi-outlet power strips or extension leads. Instead, please contact Customer Service for alternative solutions.

Getting to know your appliance







Appliance

* Not all models.

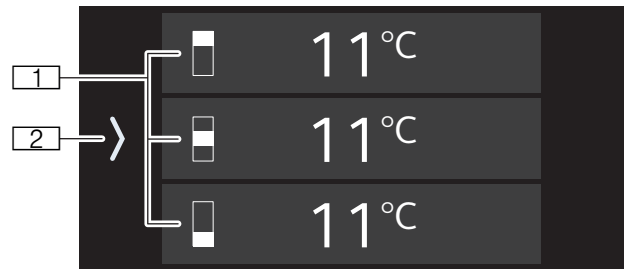
		Controls
		Main switch on/off
		Shelf
		Partition
		Rating plate
		Ventilation opening

Controls



-  Wine storage compartment temperature display
Indicates the set temperature in °C/
°F. Depending on the appliance model in
question, 2 or 3 compartments are
displayed.
-   button
Opens main menu.

Main menu



Press the  button to open the main menu.

The main menu contains the operating modes, an overview of the information texts for the appliance's functions, and the  **Settings** menu.

Mode selection

To switch on a mode, tap on it. When an operating mode is switched on, the corresponding symbol is shown on the control panel.

A window containing the information text for the selected operating mode appears.



-   button
Switches on the display light with the most
recently selected mode.
-  **שבת**
Opens the menu for setting the Sabbath
mode.

Note: This function is only visible once it has been switched on in the **Settings** menu.

All non-essential functions are switched off so you can also use the appliance on the Sabbath.

→ "Sabbath mode" on page 11

Overview of the information texts

The information texts are provided for the most relevant functions. In the overview , you will find all the information texts for the functions. When you switch on a function, the appliance will display the information text for this function. If required, you can switch off the information text for individual functions. The overview  will still show all the information texts.

In order to switch on all the information texts in the functions again, reset the appliance to its factory settings.

Settings menu

Tap  to open the settings.

Dimming effect and display light Adjust the interior lighting of the appliance.

Dimming effect

When the dimming effect is switched on, the interior lighting of the appliance slowly brightens when you open the appliance door and then slowly darkens when the appliance door is closed.

Display light

You can use the pre-programmed light modes to illuminate your bottles when the door is closed. The light modes have different illumination levels in the individual climate zones.

Display brightness and standby screen Adjust the control panel brightness and select a display option for standby mode.

Volume Set the volume of the touch key tone and the audible signal.

Home Connect Connect your refrigerator to your mobile device.

→ "Home Connect" on page 12

Sabbath mode Opens the menu for setting the Sabbath mode and displaying the Sabbath mode in the main menu.

All non-essential functions are switched off so you can also use the appliance on the Sabbath.

→ "Sabbath mode" on page 11

Self-test and reset **Self-test** Start fault analysis on your appliance.

Factory settings

Reset the appliance back to its factory settings as received on delivery.

Demo mode

After switching on the appliance, this menu item is displayed for 3 minutes. To switch Demo mode on or off later, switch the appliance off and on again. The mode is displayed again for 3 minutes.

Note: Do not store any food in Demo mode, as the appliance remains at room temperature.

The cooling function of the appliance is switched off. You can use all other functions.

Regional settings

Language

Change the display language.

Temperature unit

Select the temperature unit °C/°F.

Features

Shelf

You can pull out the shelves to reach wine bottles more easily.

Note:

The shelves separating the climate zones are not movable.

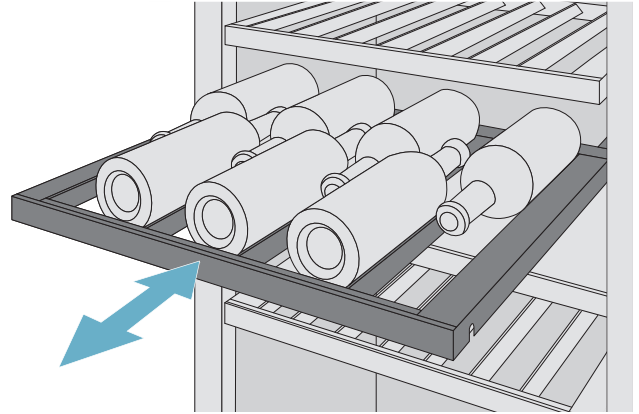

Operating the appliance

Switching on the appliance

1. Press the **main On/Off switch**.
The appliance starts refrigerating, and the light switches on when the door is open.
2. Set the required temperature.
→ "Setting the temperature" on page 11

Operating tips

- After the appliance has been switched on, it may take several hours until the set temperatures are reached.
- The sides of the housing are heated slightly in certain areas. This prevents condensation in the area of the door seal.

Switching off and disconnecting the appliance

Switching off the appliance

- Press the **main On/Off switch**.
The appliance will stop refrigerating.

Shutting down the appliance

If you do not use the appliance for a prolonged period:

1. Pull out the mains plug or switch off the fuse.
The appliance no longer cools.
2. Clean the appliance.
3. Leave the appliance open.

Setting the temperature

Recommended temperature

Wine storage compartment: 11 °C

Set the temperature of the wine storage compartment

1. Select the required compartment by tapping the temperature display.
2. Move the displayed temperature to the required value.
3. Return to the main screen with the **X** button.

Humidity

If bottles with natural corks are stored for longer than 4 weeks, the corks may shrink if the humidity is too low.

To prevent this from happening, store old wine bottles so that the cork is kept damp and increase the humidity level.

Switching humidity on and off:

1. Touch on the required compartment.
2. To switch on the higher humidity level, press **Δ Humidity** button.
The **Δ** symbol appears in the display.
3. Press **X** button to exit the menu.

To switch off the higher humidity level, press the **Δ** symbol in the start window.

Sabbath mode

All non-essential functions are switched off so you can also use the appliance on the Sabbath.

- You can select a time between 1 and 96 hours
- After the selected time expires, the appliance will switch to normal operation.
- To end Sabbath mode before expiry of the set time, tap **X**.

The appliance switches off the following:

- Audible signals
- Interior lighting
- Messages on the control panel
- Background illumination of control panel is reduced

Alarm

Door alarm

If the appliance door is open for a longer time, the door alarm (continuous audible signal) switches on.

- Close the appliance door.
The audible warning signal is switched off.

Home Connect

This appliance is Wi-Fi-capable and can be remotely controlled using a mobile device.

Note: Wi-Fi is a registered trademark of the Wi-Fi Alliance.

In the following cases, the appliance functions like a refrigerator without a network connection and can still be operated manually using the controls:

- The appliance is not connected to a home network.
- The Home Connect service is not available in the country in which the appliance is set up. For an overview of the countries in which Home Connect is available, see www.home-connect.com.

Note: Please observe the safety instructions in this user manual. Ensure that these are also observed if you operate the appliance via the Home Connect app and are not at home when doing so.

→ "Safety instructions" on page 3

Please also follow the instructions in the Home Connect app.

Setting up Home Connect

Notes

- Wait at least 2 minutes after switching on the appliance before setting up Home Connect. Only then is internal appliance initialisation complete.
- Observe the Home Connect supplementary sheet, which is either enclosed with the appliance or available for download with the instructions under www.siemens-home.bsh-group.com. Enter the E-number of your appliance in the search field.

You can connect your appliance to the Wi-Fi in 3 basic steps.

1. Install the app.
2. Connect your refrigerator to the Wi-Fi home network.
3. Connect your refrigerator to the Home Connect app.

The first time you open the menu, you will be automatically guided through initial setup. Follow the instructions on the control panel. For further information, please also see the following chapters.

The following submenus can be found in the **Home Connect** menu:

- Connect to network/Wi-Fi
- App connection
- Restoring settings

Setting up the connection to the home WLAN network (Wi-Fi)

The first time you open the menu, you will be automatically guided through initial setup. Follow the instructions on the control panel.

1. Install the **Home Connect** app on your mobile device.
2. Open the **Home Connect** menu on your refrigerator.

3. Open the app on your mobile device.
4. Log in or register with the app if access is not yet available.
5. Check the router of your Wi-Fi home network to see if a WPS function is available for automatic connection.
6. If this function is available, start automatic network connection in the **Connect to network** submenu and follow the instructions on the control panel.
7. If this function is not available, if you're not sure whether the function is available, or if automatic network connection fails, start manual network connection in the **Connect to network** submenu. The refrigerator temporarily generates its own network for connecting the mobile device.
8. Start manual network connection in the app on your mobile device.

As soon as the refrigerator is connected to the mobile device, a connection will be established between the refrigerator and your Wi-Fi home network.

Note: If the connection cannot be established, check whether there is sufficient signal strength.

Checking signal strength

The signal strength is displayed on the control panel. The signal strength should be at least 1 bar in addition to the dot. If the signal strength is too weak, the connection may be interrupted temporarily.

Improving signal strength

- Place the router closer to the refrigerator.
- Check that screening walls do not interfere with the connection.
- Install a repeater to make the signal stronger.

Connecting the refrigerator to the Home Connect app

Use this menu to connect your refrigerator to mobile devices.

1. Install the **Home Connect** app on your mobile device and log in or register.
2. Open the **Home Connect** menu on your refrigerator.
→ "Setting up Home Connect" on page 12
3. Open the **App connection** menu option.
4. Confirm the message to display the refrigerator in the app.
5. Open the app and wait until the refrigerator is displayed.
Use **Add** to confirm the connection between the app and the refrigerator.
If the refrigerator is not displayed automatically, click on **Add appliance** in the app and follow the instructions. As soon as your refrigerator is displayed, add it with **+**.
6. Follow the instructions in the app until the process is complete.

Installing updates for the Home Connect software

The refrigerator checks at regular intervals whether updates are available for the Home Connect software.

A notification window appears on the control panel when an update is available.

To install the update, tap **Install**.

Install the update later:

1. Open the **Settings** menu.
2. Tap **Software update**.
Note: This menu is only visible if an update is available.
A notification window appears.
3. To install the update, tap **Install**.

Customer Service access

If you contact Customer Service, they can access your appliance and view its status after you have given your consent. You need to have your appliance connected to your home network in order to do this.

Further information about Customer Service access and its availability in your country is available under www.home-connect.com in the Help & Support area.

1. Contact Customer Service.
2. Confirm the start of Customer Service access in the app.
During Customer Service access, the symbol  appears on the control panel.
3. As soon as Customer Service has obtained the necessary data, they will end their access.
Note: You can interrupt remote diagnostics early by switching off Customer Service access in the Home Connect app.

Restoring settings

If there is a problem when trying to establish a connection or if you would like to register the appliance in a different Wi-Fi home network (Wi-Fi), the Home Connect settings can be reset.

1. Open the **Home Connect** menu on your refrigerator.
2. Tap the **Reset settings** menu option.
3. Confirm the message to delete the network settings.

To reconnect the appliance to the home WLAN network (Wi-Fi), perform initial setup again.

→ "Setting up the connection to the home WLAN network (Wi-Fi)" on page 12

Switch on or off the connection to the home WLAN network (Wi-Fi)

1. Open the **Home Connect** menu on your refrigerator.
Note: The first time you open the menu, you will be automatically guided through initial setup. Follow the instructions on the control panel.
2. Select **Wi-Fi**.

3. To start the switching off process, press **Off**.
4. As soon as the connection to the Wi-Fi home network has been switched off, the **Wi-Fi switched off** message will appear. Press **Finish** to confirm the message.

Note: While the home WLAN network (Wi-Fi) connection is switched off, you will no longer be able to operate the appliance with your mobile device.

Information on data protection

The first time your Home Connect appliance is registered on a WLAN home network connected to the Internet (Wi-Fi), your appliance will transmit the following types of data to the Home Connect server (initial registration):

- Unique appliance identification (consisting of appliance codes as well as the MAC address of the installed Wi-Fi communication module).
- Security certificate of the Wi-Fi communication module (to ensure a secure data connection).
- The current software and hardware version of your home appliance.
- Status of any previous resetting to factory settings.

This initial registration prepares the Home Connect functions for use and is only required when you want to use these Home Connect functions for the first time.

Note: Please note that the Home Connect functions can only be utilised with the Home Connect app. Information on data protection can be called up in the Home Connect app.

Declaration of Conformity

BSH Hausgeräte GmbH hereby declares that the appliance with Home Connect functionality meets the essential requirements and the other relevant provisions of the Directive 2014/53/EU.

A detailed RED Declaration of Conformity can be found online at www.siemens-home.bsh-group.com among the additional documents on the product page for your appliance.



2.4 GHz band: 100 mW max.

5 GHz band: 100 mW max.

	BE	BG	CZ	DK	DE	EE	IE	EL
	ES	FR	HR	IT	CY	LV	LT	LU
	HU	MT	NL	AT	PL	PT	RO	SI
	SK	FI	SE	UK	NO	CH	TR	
5 GHz WLAN: for indoor use only								

Wine storage compartment

Loading bottles

To store the maximum number of wine bottles:

- store the bottles as indicated
- check that the bottles do not exceed the specified dimensions

Storage example with standard bottles

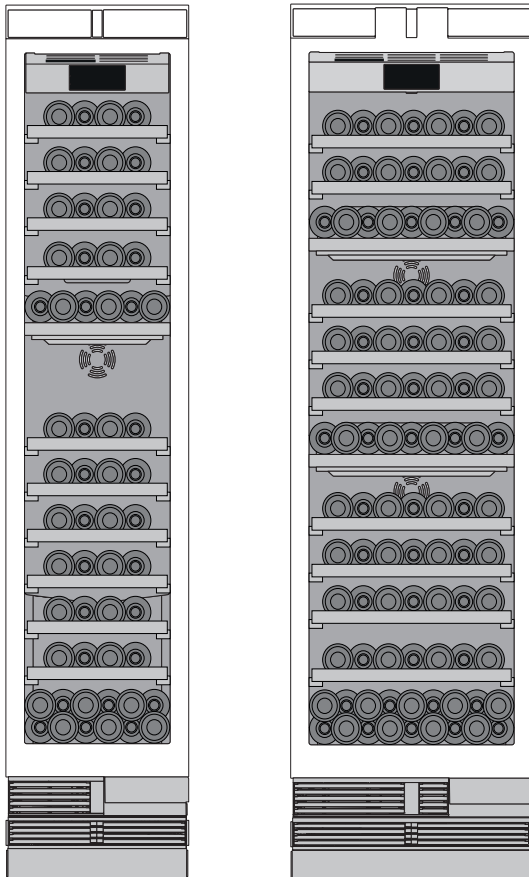
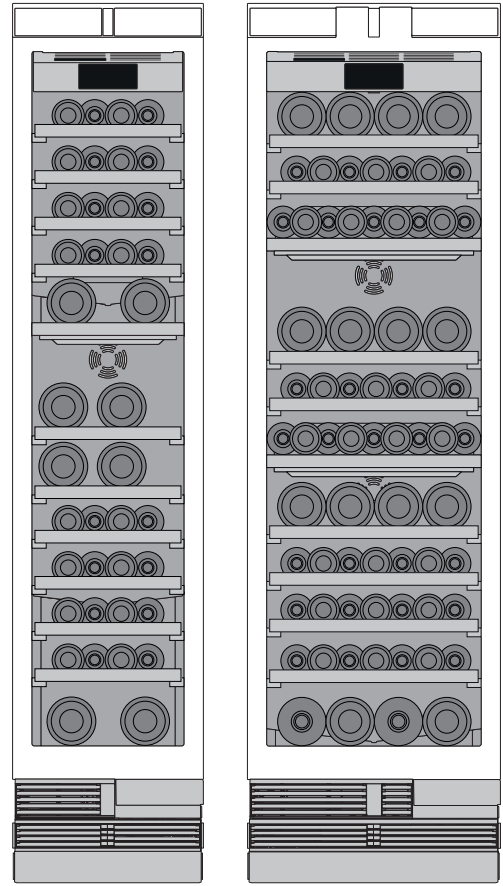
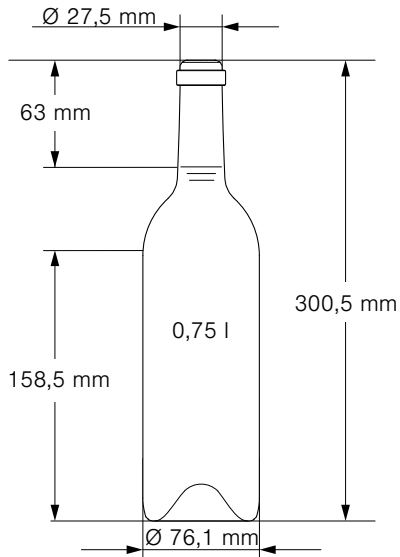

Tips for storing wine

- Unpack wine bottles – do not store in crates or cartons in the wine storage compartment.
- If bottles with natural corks are stored for longer than 4 weeks, the corks may shrink if the humidity is too low.
To prevent this from happening, store old wine bottles so that the cork is kept damp and increase the humidity level.
→ "Humidity" on page 11
- The open bottle shelves allow continuous air circulation. As a result, excess humidity is quickly removed.
- Before drinking wine, it should be warmed up slowly (chambré). Take e.g. rosé out of the appliance approx. 2–5 hours before drinking and red wine 4–5 hours beforehand. This will ensure that the wine is at the correct drinking temperature. White wine on the other hand should be served just before drinking. Sparkling wine and champagne should be chilled in the refrigerator for a short while before drinking.
- Remember that wine should always be cooled slightly lower than the ideal serving temperature as its temperature increases as soon as it is poured into a glass.

Drinking temperatures

The correct serving temperature is crucial for the taste and therefore your enjoyment of wine.

We recommend the following drinking temperatures for serving wine:

Type of wine	Drinking temperature
Full-bodied red Bordeaux	18 °C
Côtes du Rhône red/Barolo	17 °C
Full-bodied red Burgundy/red Bordeaux	16 °C
Port wine	15 °C
Young red Burgundy	14 °C
Young red wines	12 °C
Young Beaujolais/all white wines with little residual sugar	11 °C
Old white wines/Chardonnay	10 °C
Sherry	9 °C
Young white wines, from late vintage onward	8 °C
Loire/Entre-deux-Mers white wines	7 °C

Cleaning

Caution!

To avoid damage to the appliance and fittings and to prevent affecting the taste of drinks:

- Do not use cleaning agents or solvents containing chlorine, fluorine, iodine, bromine or acids.
- Do not use cleaning agents or solvents containing sand or acids.
- Do not use scouring or abrasive sponges. Metallic surfaces may corrode.
- Never clean shelves or containers in the dishwasher. These parts may become deformed.

Cleaning the display

The change in temperature and humidity can cause the controls to steam up.

Use a clean microfibre cloth for cleaning.

Cleaning the appliance interior

Proceed as follows:

1. Pull out the mains plug or switch off the fuse.
2. Take out the bottles and store in a cool location if possible.
3. Clean the appliance with a soft cloth, lukewarm water and a little pH-neutral washing-up liquid.

Caution!

The rinsing water must not run into the light or through the drainage hole into the evaporation area.

4. Wipe the door seal with clean water and dry thoroughly with a cloth.
5. Reconnect the appliance and put the bottles back.

Cleaning the equipment

To clean, take the variable parts out of the appliance.
→ "Features" on page 10

Care instructions for stainless steel surfaces

When taking care of and cleaning stainless steel surfaces, use only cleaning agents that are suitable for stainless steel and a stainless steel cleaning cloth.

You can purchase a suitable stainless steel cleaning cloth from Customer Service.

To prevent visible scratches, clean the stainless steel surface in the direction of the grain.

Noises

Normal noises

Droning: A motor is running, e.g. refrigerating unit, fan.

Bubbling, buzzing or gurgling: Refrigerant is flowing through the tubes.

Clicking: The motor, switches or solenoid valves are switching on and off.

Preventing noises

Appliance is not level: Align appliance using a spirit level. Adjust the height of the feet. If the feet have already been moved right out, but the appliance is still not level, place e.g. a thin wooden plate underneath.

Containers, shelves or storage compartments wobble or stick: Check the removable fittings and re-insert if required.

Bottles or receptacles are touching each other: Move bottles or receptacles away from each other.

Lighting

Your appliance features a maintenance-free LED light. Only Customer Service or authorised technicians may repair the light.

What to do in the event of a fault

Before you call Customer Service, use this table to check whether you can rectify the fault yourself.

Appliance

Temperature differs greatly from the set value.	
	Switch off appliance for 5 minutes. → "Switching off and disconnecting the appliance" on page 11 If the temperature is too warm, check temperature again after a couple of hours. If the temperature is too cold, check temperature again on the following day.
Displays do not illuminate.	
The mains plug has not been inserted properly.	Connect mains plug.
The fuse has been tripped.	Check the fuses.
The power has failed.	Check whether the power is on.
The refrigeration unit is switching on more frequently and for longer.	
The appliance has been opened frequently.	Do not open the appliance unnecessarily.
The ventilation openings are covered up.	Remove obstructions.
Large quantities of fresh food have been put in.	Switch on super cooling promptly in advance.
Appliance is not cooling, display and lighting are lit.	
Demo mode is switched on.	Switch Demo mode off.

Customer Service, product / production number and technical data

Customer Service

If you have any queries, are unable to rectify faults on the appliance yourself or if your appliance needs to be repaired, contact Customer Service.

You can solve many problems yourself by consulting the information on troubleshooting in these instructions or on our website. If this is not the case, contact Customer Service.

We will always find an appropriate solution and try to avoid unnecessary visits being made by a Customer Service technician.

With any warranty claims, we will make sure that your appliance is repaired by trained Customer Service technicians using genuine spare parts, including after the manufacturer's warranty has expired.

For safety reasons, repairs to the appliance should only be carried out by trained specialist staff. The warranty claim becomes void if repairs or interventions have been carried out by persons not authorised by us for that purpose or if our appliances have been fitted with spare, supplementary or accessory parts that were not genuine parts and then resulted in a defect.

Function-relevant genuine spare parts according to the corresponding Ecodesign Directive can be obtained from Customer Service for a period of at least 10 years from the date on which your appliance was placed on the market within the European Economic Area.

Note: Under the terms of the manufacturer's warranty applicable to the location, the use of Customer Service is free of charge. The minimum duration of the warranty (manufacturer's warranty for private consumers) in the European Economic Area is 2 years (except for Denmark and Sweden, where it is 1 year) according to the terms of warranty applicable to the location. The terms of warranty do not affect other rights or claims held by yourself under local legislation.

Detailed information about the warranty period and terms of warranty in your country are available from Customer Service, your dealer or our website.

When contacting Customer Service, you will need the product number (E-Nr.) and the production number (FD) of your appliance.

The contact details for Customer Service can be found in the enclosed Customer Service directory or on our website.

Product number (E-Nr.) and production number (FD)
The product number (E-Nr.) and the production number (FD) can be found on the rating plate of the appliance.

Make a note of your appliance's details and the Customer Service telephone number to find them again quickly.

Technical data

Refrigerant, net volume and further technical specifications can be found on the rating plate.

More information about your model can be found online at <https://www.bsh-group.com/energylabel> (only applies to countries in the European Economic Area). This web address is linked to the official EU EPREL product database. At the time of printing its web address had not yet been published. Please then follow the instructions on how to search for models. The model identifier is made up of the characters before the slash in the product number (E-Nr.) on the rating plate. Alternatively, you can also find the model identifier in the first line of the EU energy label.

Appliance self-test

Your appliance features a self-test programme; this displays the fault which your Customer Service team can rectify.

1. Press the  button to open the settings.
2. Tap on the **Self-test and reset** menu.
3. Tap the **Self-test** menu option.
The information text for the self-test will appear.
4. Tap **Start**.
The self-test programme will start.
5. If faults are present, they will be displayed.
In this case, follow the instructions on the display.
6. The appliance restarts.

When the self-test has ended, the appliance switches over to normal operation.

Obtaining advice and ordering repairs if a fault occurs

Contact information for all countries can be found on the enclosed Customer Service list.

GB	0344 892 8999	Calls charged at local or mobile rate.
IE	01450 2655	€0.03 per minute at peak. Off peak: €0.0088 per minute.
US	866 447 4363	Toll-free

BSH Hausgeräte GmbH

Carl-Wery-Str. 34
81739 München

GERMANY

Manufactured by BSH Hausgeräte GmbH under Trademark License of Siemens AG

siemens-home.bsh-group.com



8001190924 (0008) en