

1. SAFETY PRECAUTIONS.....	2
2. INTENDED USE OF THE APPLIANCE.....	3
3. INSTALLATION AND CONNECTION .....	4
3.1 Choice of location and ventilation .....	4
3.2 Positioning and levelling the appliance.....	5
3.3 Electrical connection .....	5
4. PRODUCT DESCRIPTION .....	6
4.1 Shelves .....	6
4.2 Top door shelf and bottle container .....	6
4.3 Air vents .....	7
5. MODE OF OPERATION.....	7
6. MAINTENANCE AND CLEANING.....	10
6.1 Cleaning the appliance .....	10
6.2 Switching off the appliance .....	10
6.3 Practical advice for saving energy .....	10
7. TROUBLESHOOTING GUIDE .....	11



**INSTRUCTIONS FOR THE USER:** these instructions contain user recommendations, description of the commands and the correct procedures for cleaning and maintenance of the appliance.



**INSTRUCTIONS FOR THE INSTALLER:** these are intended for the **qualified technician** who must install the appliance, set it functioning and carry out an inspection test.

## 1. SAFETY PRECAUTIONS

Keep the instruction handbook in a safe place; it contains important information which must be applied when installing, using and servicing the appliance. The handbook must be kept so that it can be passed on to any subsequent owners of the appliance.

The manufacturer declines all responsibility in case of failure to comply with the following precautions:

- The Minibar must not be installed outdoors, even if it is sheltered by a roof.
- When connecting the appliance, it is recommended not to use extension cables or multiple sockets. If the Minibar is installed between other pieces of furniture, make sure that the cable is not bent or pinched.
- Do not carry out cleaning or maintenance without having first disconnected the minibar from the power supply.
- In order for it to work properly and to have a low power consumption, it is important that it is installed correctly. To obtain the best performance, make sure that the refrigeration unit is always ventilated.



**WARNING: Fire hazard/flammable materials.**

- Do not obstruct the ventilation slots of the appliance or the structure in which it is enclosed.
- Do not use mechanical devices or means other than those recommended by the manufacturer to speed up the defrosting process.
- Do not use electrical appliances other than those recommended by the manufacturer inside the storage compartment of the appliance.
- Do not use mechanical or electrical devices inside the appliance.
- Keep the refrigerator away from flames or incandescent substances before disposal.
- Supervise children carefully to prevent them from playing with this appliance.
- The appliance can be used by children aged from 8 years and above and by persons with reduced physical, sensory or mental capabilities or who lack experience and knowledge as long as they are supervised or instructed on how to use the appliance safely and understand the hazards involved.
- Children aged from 3 to 8 years are allowed to load and unload the minibar.
- Do not use extension cords with the power cable.
- Do not store explosive substances such as aerosol cans containing flammable propellants in the appliance.
- Electric shock hazard.
- Take care not to damage the refrigerant circuit. It contains isobutane (R600a), which is an environmentally friendly natural gas. This is a flammable gas.
- Opening the door for long periods can cause a significant increase of the temperature in the compartments of the appliance.
- Clean regularly surfaces that can come in contact with food and accessible drainage systems.
- If the refrigerant circuit becomes damaged, make sure that there are no flames or ignition sources in the room. Ventilate the room.
- Do not allow hot objects to touch the plastic parts of the appliance.
- Do not store flammable gases and liquids inside the appliance.
- Do not place flammable products or objects, or products that contain flammable liquids, inside, near or on top of the appliance.
- Do not touch the compressor or condenser. They are HOT!
- If the minibar is left empty for long periods, switch off, defrost, clean, dry and leave the door open to prevent mould developing within the appliance.
- **WARNING:** Do not place portable multiple sockets or power supplies at the back of the appliance.
- Risk of children becoming trapped.

## Disposal and environmental care instructions:

- The packaging materials are non-polluting and therefore environmentally friendly and recyclable.
- Please ask your retailer or at the waste collection and recycling centres about for the correct disposal of the packaging.
- Dispose of the packaging and parts of it responsibly. Especially plastic bags can be a choking hazard for children.
- Remove the doors.
- Position the shelves so that children cannot get into the appliance easily.
- Cut the power cable and remove it together with the plug.
- The old appliance also has to be disposed of correctly by taking it to a company in your area authorized to collect disused household electrical appliances. Correct disposal allows precious materials to be recovered.



This appliance conforms to the European directive 2012/19/EU (WEEE) and must be disposed of separately from other waste at the end of its service life. The appliance does not contain substances in quantities sufficient to be considered hazardous to health and the environment, in accordance with current European directives.

## 2. INTENDED USE OF THE APPLIANCE



### Warning!

- Only use the minibar for cooling and storing drinks and snacks in closed packaging.
- Do not store perishable foods in the minibar.
- Food can be stored in its original packaging or in suitable containers.
- The minibar has not been designed to come into contact with food.
- The minibar has not been designed for storing medicines. For these products, see the instructions on the relative leaflet.

This appliance is designed for use in a domestic or similar environment, for example:

- Staff kitchen areas in shops, offices and other work environments;
- Farm accommodation and by guests in hotels, motels and other residential type environments;
- Bed and breakfast establishments;
- Catering services and similar non-retail applications.
- The minibar must not be used on public transport vehicles.

Smeg cannot be held liable for any damage incurred as a result of incorrect use of the appliance. Leak tests have been carried out on the refrigerant circuit and the minibar complies with the safety regulations for electrical appliances.



**Caution: the manufacturer declines all responsibility for injury or damage caused by failure to comply with the above regulations or deriving from tampering with even just one part of the appliance and the use of non-original spare parts.**

### Energy label

Information about the performance of your appliance can be found in the EU EPREL database. Use the following link and enter the model name (which can be found on the identification plate):

<https://eprel.ec.europa.eu>

The website can be accessed quickly using the QR code on the energy label. Use a device with a QR reader app.

The energy label should be kept together with all the documents supplied with the appliance.



### 3. INSTALLATION AND CONNECTION

#### 3.1 Choice of location and ventilation

Always place the appliance in a dry place with satisfactory ventilation. Never expose it to direct sunlight or install it outdoors. Depending on its climate class (stated on the nameplate inside), the appliance can be used in different temperature conditions.

The compressor type cooling system produces heat and requires good ventilation so rooms with poor ventilation are not very suitable.

The minibar should be installed in a room in which there is a ventilation opening and it is essential not to obstruct the grilles that allow the appliance to be well ventilated. Avoid positioning the appliance where it is exposed to directly sunlight or close to other sources of heat. If this is unavoidable, in order to prevent the proper operation of the product from being compromised, a suitable insulation board must be used. Otherwise, locate the appliance at least 3 cm away from electrical or gas cookers and at least 30 cm away from combustion heaters or radiators.

Minimum installation distances:

from the back: 32mm

from the sides: 15mm

from the floor: 7mm (feet adjusted to the minimum, completely screwed in);

25 mm (maximum feet length) if the clearance at the sides is less than 20 mm.

Class	Ambient temperature
SN (Subnormal)	from + 10° C to + 32° C
N (Normal)	from + 16° C to + 32° C
ST (Subtropical)	from + 18° C to + 38° C
T (Tropical)	from + 18° C to + 43° C

To allow proper cooling of the condenser, the minibar must not be placed too close to the wall. To prevent this, there are two plastic spacers at the lower back of the appliance.

Position the appliance so that the **door can be opened fully**.

Take care not to scratch or damage the floor when installing the appliance on parquet or linoleum. If necessary, when positioning slide the appliance over pieces of wood or a mat to the point decided for connection to the electrical mains.

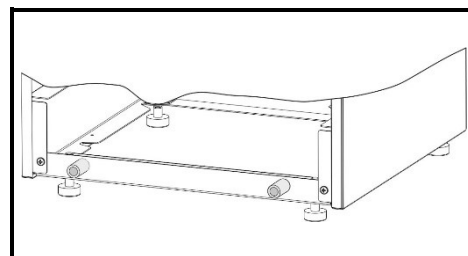



## Instructions for the installer

GB-IE

### 3.2 Positioning and levelling the appliance

Place the appliance on a **firm, level surface**. To compensate for any unevenness in the floor, the appliance has four adjustable feet. This gives it added stability and makes it easier to move around and position. Take great care **when moving the appliance not to damage the floor** (for example, when installing on a parquet floor).

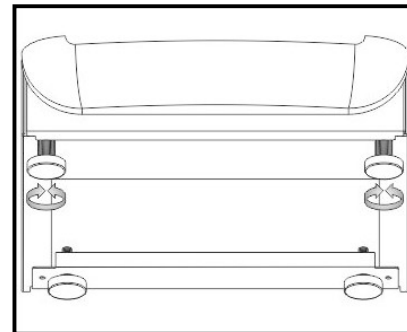

### 3.3 Electrical connection

Connect the appliance's power supply lead to a mains socket with earth contact, installed in accordance with electrical safety regulations. The rated voltage and frequency are stated on the nameplate inside the appliance. The appliance must be connected to the electrical mains and earthed in compliance with the relevant regulations and requirements. The appliance can tolerate fluctuations in voltage of between -15% and +10% of the nominal value indicated on the data plate. If the power supply lead has to be replaced, this operation must only be carried out by an **authorised Smeg technical service engineer**. The power plug must be accessible after the appliance has been installed.



#### 4. PRODUCT DESCRIPTION

- 1** Inside light.
- 2** Thermostat switch.
- 3** Removable shelves.
- 4** Top door shelf.
- 5** Bottle shelf.
- 6** Bottle/jar container.

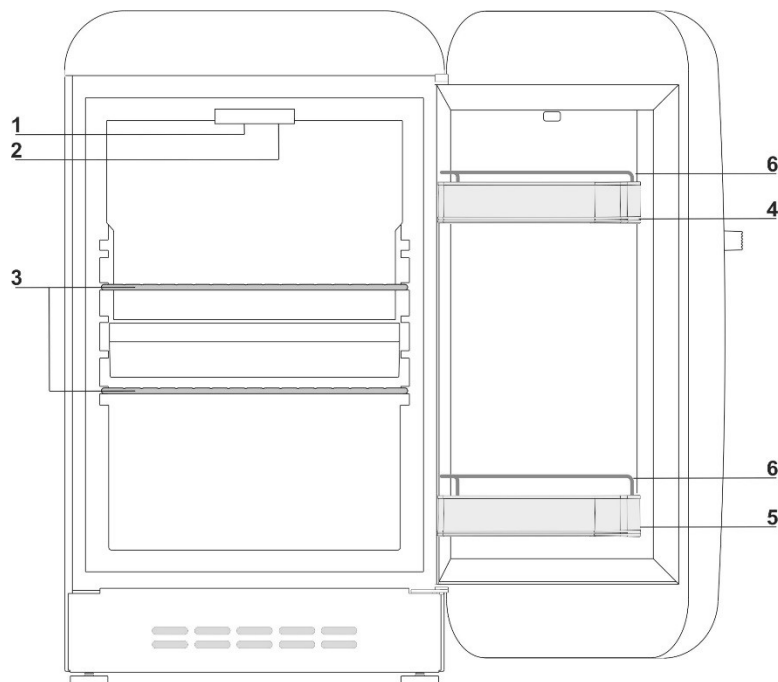

When the appliance door is opened, the light comes on; it remains on until the door is completely closed again.

##### 4.1 Shelves

The appliance comes complete with several shelves which can be set at different heights by placing them on the runners provided. Then change the position of the shelf or shelves as you require. For easy removal of all internal accessories, the door has to be opened completely.

##### 4.2 Top door shelf and bottle container

The inside of the door is fitted with a shelf for storing tubes, small packages and jars. The bottom of the door has a shelf to take vertical bottles and cans.

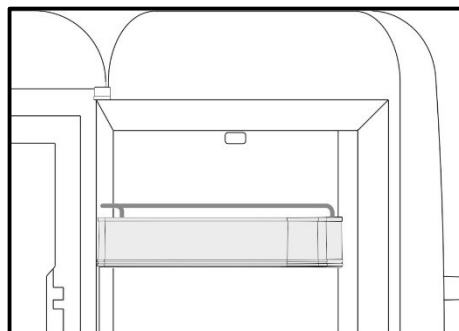
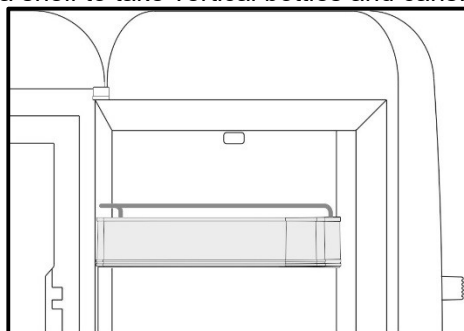

The top door shelf and the bottle shelf, as well as the bottle/jar container, are not interchangeable and **must not be inverted** after being taken out for cleaning. Otherwise, bottles may fall out when the door is opened.

The shelf and container can be removed for cleaning. To remove them from the door, tap them upward with your fist first on one side of the insertion zone and then on the other. Do not place excessively heavy bottles on the bottle shelf, and place bottles on the shelf gently when loading them.



## 4.3 Air vents

The ventilation **must never be obstructed in any way**; this would impair operation of the appliance.

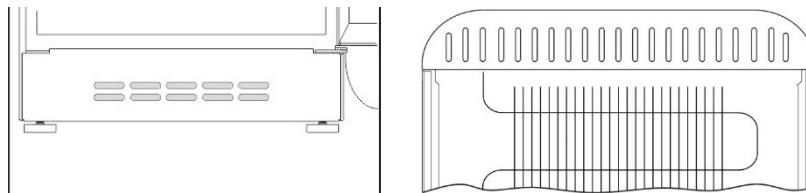

## 5. MODE OF OPERATION

The minibar can operate in two different modes:



**NORMAL:** a switch is used to select the minimum and maximum temperature.



**SMART:** detects the presence of a guest in the room and starts the compressor when the guest leaves.

The minibar is set to NORMAL by default.

It is possible to adjust the storage temperature inside the minibar by using the selector positioned on the front of the minibar.

- when in the **"OFF"** position, the Minibar is switched off
- when in the **"\*"** position, the Minibar operates at a higher constant internal temperature (less cold)
- when in the **"\*\*"** position, the Minibar operates at a lower constant internal temperature (colder)

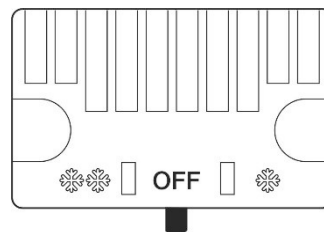

**Important:** changes in weather conditions (temperature and humidity) and the frequency with which the door is opened may affect the appliance's operating temperatures.

# Instructions for the User



The SMART SYSTEM switches the compressor on and off according to whether the guest is in the room. An Energy Saver is required in order to use the SMART system. The customer enters the room and inserts the card into the card slot, the Energy Saver sends a signal to the Smart System to indicate that there is a guest in the room and the minibar's compressor stops (the products inside remain fresh for a long time because of the cold released by the accumulation plate). When the customer leaves the room and removes the card from the Energy Saver, another message is sent to the Smart System and the minibar starts up again. If the guest remains in the room for a long time and the cold that has accumulated in the plate runs out, the minibar starts up again automatically in order to keep the products inside it cool. The minibar operates in high energy saving mode if the room remains unoccupied for a long time.







## Instructions for the User

GB-IE

### WARNING!

To make the connection "SIGNAL" is necessary:

- purchase the appropriate cable (not supplied with the minibar), available from the retailer or qualified technical assistance.

There are two power plugs (POWER and SIGNAL) on the back of the minibar.

Connect the "POWER" plug to the room socket to be used for the Minibar (socket not connected to the energy saving unit).

Connect the "SIGNAL" plug to any socket that is connected to the Energy Saver.

NOTE: The Minibar operates in NORMAL mode if the "SIGNAL" plug is not connected. This means that its operation is not based on the presence of a guest in the room and is regulated by the temperature chosen by the Customer through the selector described above.

### WARNING!

If the POWER and SIGNAL cables are inverted, the Minibar will operate when the guest is in the room and it will switch off when the guest is out of the room.

To make sure that the cables have been connected the right way round, make sure that the light inside the minibar lights up when the minibar door is opened, after making sure that:

- 1) The Energy saver is not in operation i.e. that a smart card has not been inserted.
- 2) The Minibar is switched on (the temperature selector on the front of the minibar is not in the "OFF" position)

If the light does not come on, invert the two power cables.

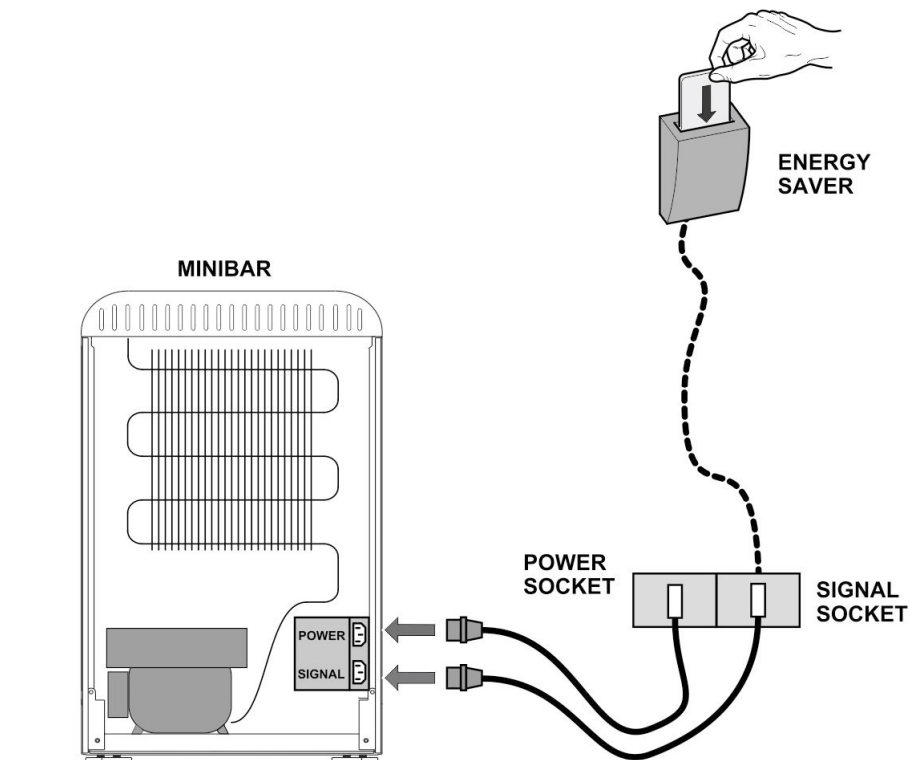

### Warning!

If you switch the power off, do not turn it back on (reconnect the minibar to the power supply) for at least 15 minutes. Otherwise, the compressor may stop for a few minutes before resuming normal operation.



## 6. MAINTENANCE AND CLEANING

### 6.1 Cleaning the appliance

**The appliance must never be cleaned by children.**

Before cleaning, disconnect the plug from the electrical mains. Clean the outside using only water and a gentle liquid detergent or an ordinary detergent for washable surfaces (such as a window-cleaning product). Never use products containing abrasives or substances which may attack the lacquered or painted parts, acids or chemical solvents. Use a sponge or a soft cloth. Do not use steam cleaners to clean the inside; we recommend the use of refrigerator-specific disinfectants.

Remove the shelves and accessories, taking care not to apply excessive force when removing. Follow the instructions provided in the "Top door shelf and bottle container" section carefully. Never wash removable plastic parts in the dishwasher; use only warm water and washing-up liquid or water and vinegar. Take care not to wet the electrical lighting components with water or detergents. Clean the seals with warm water and then dry.

Make a periodic check on the condensation drip tray at the rear, and clean it if necessary.

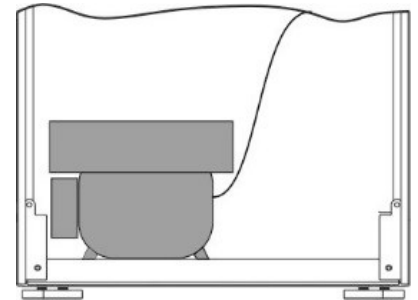

### 6.2 Switching off the appliance

If the appliance is to be out of use for some time, turn the temperature selector to **OFF**.

Then empty the appliance, disconnect it from the mains, and dry any residual moisture which has collected. Leave the door ajar to prevent the humidity and trapped air from creating unpleasant smells.

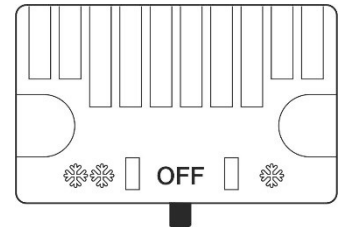

### 6.3 Practical advice for saving energy

- Install the appliance in a cool, well ventilated place, protected against direct sunlight and well away from heat sources.
- Do not place hot foods in the appliance. Wait for foods and drinks to cool to room temperature before placing them on the shelves.
- Open the door(s) as infrequently and for as short a time as possible to prevent the appliance from warming up too much.
- Clean the condenser (on the rear) periodically to prevent the appliance from losing efficiency.
- On models equipped with intensive cooling, do not leave this function activated for longer than absolutely necessary.
- If the appliance is to be out of use for a long period, it is best to empty it and switch it off.



## 7. TROUBLESHOOTING GUIDE

Your new appliance is designed and built to strict quality standards. This section is intended to enable you to identify the origin of any malfunctions which may occur before contacting the Smeg After-Sales Service.

PROBLEM	POSSIBLE CAUSE	PROBABLE SOLUTION
Appliance not cooled sufficiently:	<ul style="list-style-type: none"> <li>- inside temperature setting thermostat set too low (*) (this corresponds to higher appliance temperature);</li> <li>- door opened often or for long periods;</li> <li>- door not closing properly;</li> <li>- rise in outside temperature.</li> </ul>	<ul style="list-style-type: none"> <li>- turn the regulator to **;</li> <li>- open the door less often and for as short a time as possible;</li> <li>- check that the foods are arranged on the shelves correctly and are not preventing the door from closing properly, and that the appliance is well levelled on the floor;</li> <li>- check that the gasket is sealing properly and is not damaged.</li> </ul>
Too much condensation forming in appliance:	<ul style="list-style-type: none"> <li>- check that the door gaskets are providing an airtight seal on the appliance;</li> <li>- door opened often or for long periods;</li> <li>- foods not properly covered or stored in airtight containers.</li> </ul>	<ul style="list-style-type: none"> <li>- in case of cracks, try to soften the gasket by pulling it with one hand and sliding your closed fingers along the inside;</li> <li>- open the door less often and for shorter times, especially when the appliance is working in warm, humid conditions;</li> <li>- cover the containers and seal foods.</li> </ul>
Temperature inside appliance too cold:	<ul style="list-style-type: none"> <li>- cooling temperature regulator device set too high (**).</li> </ul>	<ul style="list-style-type: none"> <li>- turn the selector to a lower setting (*).</li> </ul>
If the appliance does not work or it malfunctions, make sure that:	<ul style="list-style-type: none"> <li>- The plug is inserted correctly into the mains socket</li> <li>- The mains voltage is the same as the one indicated on the DATA PLATE</li> <li>- The Minibar has not been placed close to heat sources or in direct sunlight</li> <li>- There has not been a power failure</li> </ul>	<ul style="list-style-type: none"> <li>- Place the plug correctly in the power socket</li> <li>- Check, together with a qualified technician, that the mains voltage is the same as that required by the appliance</li> <li>- Move the Minibar to a suitable position</li> <li>- Wait for the power supply to come back on (the Minibar may not operate correctly for a few minutes).</li> </ul>