

SIEMENS

Hob

EZ9..KZ...

[en] Instruction manual







Register your product on My Siemens and discover exclusive services and offers.
siemens-home.bsh-group.com/welcome

The future moving in.

Siemens Home Appliances

Table of contents

	Intended use	5		Wireless temperature sensor	23
	Important safety information	6	Preparing and maintaining the wireless temperature sensor		
	Causes of damage	8	Connecting the wireless temperature sensor to the control panel.		
	Overview	8	Cleaning		
	Environmental protection	9	Changing the battery		
	Tips for saving energy	9	Declaration of Conformity		
	Environmentally-friendly disposal	9		Cooking sensor	26
	Induction cooking	9	Cooking processes with the cooking sensor		
	Advantages of induction cooking	9	Benefits		
	Cookware	9	Tips for cooking with the cooking sensor		
	Getting to know your appliance	11	Setting the boiling point		
	Cooking surface	11	Setting procedure		
	The control panel	11	Recommended dishes		
	Overview of the menus	12	Meal assistant		
	Cooking position display	13		powerMove Pro	33
	Activate the active Light lighting	14	Activation		
	Residual heat indicator	14	Deactivating		
	Operating the appliance	14		Childproof lock	34
	First-time use	14	Activating and deactivating the childproof lock		
	Switching the hob on and off	14	Childproof lock		
	Configuring cooking position settings	15		Pause	34
	Chef's recommendations	15	Activation		
	Time-setting options	18	Deactivating		
	Cooking timer	18		Automatic safety cut-out	34
	Short-term timer	19			
	Stopwatch function	19	Basic settings		
	PowerBoost function	20	To go to the basic settings:		
	Activation	20	Basic settings menu		
	Deactivating	20	Exiting the basic settings		
	panBoost function	21	Saving or discarding changes		
	Recommendations for use	21		Home Connect	36
	Activation	21	Setting up		
	Deactivating	21	Home Connect settings		
	Keep warm function	22	Software update		
	Activation	22	Remote diagnostics		
	Deactivating	22	About data protection		
	Transferring settings	22	Declaration of Conformity		
	Activation	22		Hood control	41
			Setting up		
			Disconnecting from the network		
			Control the hood via the hob		
			Hood control settings		

 Maximum power consumption	44
 Cleaning	44
Hob	44
Hob surround	44
 Frequently Asked Questions (FAQ)	45
 Trouble shooting	48
Information, warnings and fault codes	48
Tips	48
Demo mode	49
 Customer service	50
E number and FD number	50

Additional information on products, accessories, replacement parts and services can be found at www.siemens-home.bsh-group.com and in the online shop www.siemens-home.bsh-group.com/eshops

Intended use

Read these instructions carefully. Please keep the instruction and installation manual, as well as the appliance certificate, in a safe place for later use or for subsequent owners.

Check the appliance after removing it from the packaging. If it has suffered any damage in transport, do not connect the appliance, contact the Technical Assistance Service and provide written notification of the damage caused, otherwise you will lose your right to any type of compensation.

Only a licensed professional may connect appliances without plugs. Damage caused by incorrect connection is not covered under warranty.

This appliance must be installed according to the installation instructions included.

This appliance is intended for private domestic use and the household environment only. The appliance must only be used for the preparation of food and beverages. The cooking process must be supervised. A short cooking process must be supervised without interruption. Only use the appliance in enclosed spaces.

This appliance is intended for use up to a maximum height of 4000 metres above sea level.

Do not use covers. These can cause accidents, for example due to overheating, catching fire or materials shattering.

Only use safety devices or child protection grilles approved by ourselves. Unsuitable safety devices or child protection grilles may result in accidents.

This appliance is not intended for operation with an external clock timer or a remote control.

This appliance may be used by children over the age of 8 years old and by persons with reduced physical, sensory or mental capabilities or by persons with a lack of experience or knowledge if they are supervised or are instructed by a person responsible for their safety how to use the appliance safely and have understood the associated hazards.

Children must not play with, on, or around the appliance. Children must not clean the appliance or carry out general maintenance unless they are at least 15 years old and are being supervised.

Keep children below the age of 8 years old at a safe distance from the appliance and power cable.

If you are using the cooking sensor, make sure that the cooking zone you have configured is the one on which the cookware with the wireless temperature sensor is located.

If you wear an active implantable medical device (e.g. a pacemaker or defibrillator), check with your doctor that it complies with Council Directive 90/385/EEC of 20th June 1990, DIN EN 45502-2-1 and DIN EN 45502-2-2, and that it has been chosen, implanted and programmed in accordance with VDE-AR-E 2750-10. If these conditions are satisfied, and if, in addition, non-metal cooking utensils and cookware with non-metal handles are used, it is safe to use this induction hob as intended.

Important safety information

Warning – Risk of fire!

- Hot oil or grease ignite very easily. Never leave hot fat or oil unattended. Never use water to put out burning oil or fat. Switch off the hob. Extinguish flames carefully using a lid, fire blanket or something similar.
- The cooking surface becomes very hot. Do not set any combustible objects on the hob. Do not store any objects on the hob.
- The appliance gets hot. Do not keep combustible objects or aerosol cans in drawers directly underneath the hob.
- The hob switches off automatically and can no longer be operated. It may switch on unintentionally at a later point. Switch off the circuit breaker in the fuse box. Contact the after-sales service.
- Do not use hob covers here. They can cause accidents, for example due to overheating, catching fire or materials shattering.

Warning – Risk of burns!

- The cooking positions and the adjacent areas, particularly the hob frame (if present), become extremely hot. Never touch the hot surfaces. Keep children away from the appliance.
- The hotplate heats up but the display does not work. Switch off the fuse in the fuse box. Inform technical after-sales service.
- Metal objects on the hob quickly become very hot. Never set metal objects, such as knives, forks, spoons, lids, or other objects that contain metal on the hob.
- After each use, always turn off the hob at the main switch. Do not wait until the hob turns off automatically after the pan is removed.

Warning – Risk of electric shock!

- Incorrect repairs are dangerous. Repairs may only be carried out and damaged power cables replaced by one of our trained after-sales technicians. If the appliance is defective, unplug the appliance from the mains or switch off the circuit breaker in the fuse box. Contact the after-sales service.
- Do not use any high-pressure cleaners or steam cleaners, which can result in an electric shock.
- A defective appliance may cause electric shock. Never switch on a defective appliance. Unplug the appliance from the mains or switch off the circuit breaker in the fuse box. Contact the after-sales service.
- Cracks or fractures in the glass ceramic may cause electric shocks. Switch off the circuit breaker in the fuse box. Contact the after-sales service.

Warning – Hazard due to magnetism!

The wireless cooking sensor is magnetic. The magnetic elements may damage electronic implants, e.g. pacemakers or insulin pumps. People fitted with electronic implants should therefore not carry the cooking sensor in their pockets and always keep it at least 10 cm away from their pacemaker or similar medical device.

Warning – Risk of fault!

A fan is located on the underside of this hob. If a drawer is located on the underside of the hob, do not store any small or sharp objects, paper or tea towels in it. These may be sucked in and damage the fan or impair the cooling. There must be a clearance of at least 2 cm between the contents of the drawer and the fan entry point.

 Warning – Risk of injury!

- The wireless cooking sensor is powered by a battery, which may become damaged if it is exposed to high temperatures. Remove the sensor from the cookware and store it away from any heat sources.
- The cooking sensor may be very hot when removing it from the saucepan. Wear oven gloves or use a tea towel to remove it.
- When cooking in a bain marie, the hob and cooking container could shatter due to overheating. The cooking container in the bain marie must not directly touch the bottom of the water-filled pot. Only use heat-resistant cookware.
- Saucepans may suddenly jump due to liquid between the pan base and the cooking position. Always keep the cooking position and saucepan bases dry.

Causes of damage

Caution!

- Rough pan bases may scratch the hob.
- Avoid leaving empty pots and pans on the hotplate. Doing so may cause damage.
- Do not place hot cookware on the control panel, the display areas, the hob frame or the light strips at the sides. This may cause damage.
- Hard or pointed objects dropped on the hob may damage it.
- Aluminium foil and plastic containers will melt if placed on the hotplate while it is hot. The use of laminated sheeting is not recommended on the hob.

Overview

You will find the most frequently caused damage in the following table:

Damage	Cause	Measure
Stains	Boiled over food.	Remove boiled over food immediately with a glass scraper.
	Unsuitable cleaning agent.	Only use cleaning agents that are suitable for this type of hob.
Scratches	Salt, sugar and sand.	Do not use the hob as a work surface or storage space.
	Cookware with rough bases scratch the hob.	Check the cookware.
Discolouration	Unsuitable cleaning agent.	Only use cleaning agents that are suitable for this type of hob.
	Pan abrasion.	Lift pots and pans when moving them.
Chips	Sugar, food with a high sugar content.	Remove boiled over food immediately with a glass scraper.

Environmental protection

In this section, you can find information about saving energy and disposing of the appliance.

Tips for saving energy

- Always use a matching lid with your cookware. Cooking without a lid consumes significantly more energy. Use a glass lid. This allows you to see into the pan without removing the lid.
- Use cookware with a flat base. Uneven bases increase the energy consumption.
- Always place items of cookware inside the usable area of the cooking surface.
- Use small pots and pans to cook small quantities. Using cookware that is big but barely filled requires a lot of energy.
- Cook with as little water as possible. This saves energy and preserves the vitamins and minerals in vegetables.
- Switch to a lower power level in good time. This prevents energy from being wasted.

Environmentally-friendly disposal

Dispose of packaging in an environmentally-friendly manner.



This appliance is labelled in accordance with European Directive 2012/19/EU concerning used electrical and electronic appliances (waste electrical and electronic equipment - WEEE). The guideline determines the framework for the return and recycling of used appliances as applicable throughout the EU.

The wireless cooking sensor is battery-powered. Dispose of spent batteries in an environmentally responsible manner.

Induction cooking

Advantages of induction cooking

Induction cooking is fundamentally different from traditional cooking methods, as heat builds up directly in the item of cookware. This offers numerous advantages:

- Saves time when boiling and frying.
- Energy savings.
- Easier to care for and clean. Spilled food does not burn on as quickly.
- Heat control and safety – the hob increases or decreases the heat supply as soon as the user changes the setting. If the cookware is removed, the induction cooking position immediately interrupts the heat supply without it having been switched off.

Cookware

Only use ferromagnetic cookware for induction cooking, such as:

- Cookware made from enamelled steel
- Cookware made from cast iron
- Special induction-compatible cookware made from stainless steel.

To find out whether your cookware is suitable for induction cooking, check whether a magnet is attracted to the base of the item or refer to the manufacturer's specifications.

Some induction cookware does not have a fully ferromagnetic base:

- If the base of the cookware is only partially ferromagnetic, only the area that is ferromagnetic will heat up. This may mean that heat will not be distributed evenly. The non-ferromagnetic area may not heat up to a sufficient temperature for cooking.

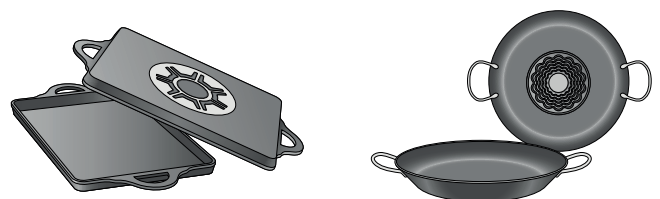

- The ferromagnetic area will also be reduced if the material from which the base of the cookware is made contains aluminium, for example. This may mean that the cookware will not become sufficiently hot or even that it will not be detected.

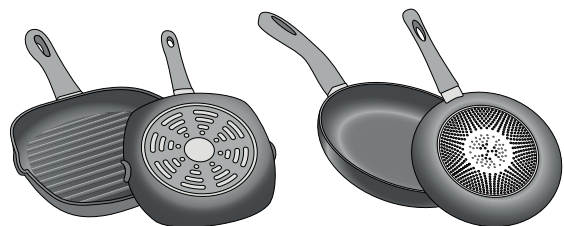

Unsuitable pans

Never use diffuser hobs or pans made from:

- common thin steel
- glass
- earthenware
- copper
- aluminium

Properties of the base of the cookware

The material(s) from which the base of the cookware is made can affect the cooking result. Cookware made of materials that distribute heat evenly, such as saucepans with a stainless steel sandwich base, save time and energy.

Cookware with a completely flat base works best. If the base of the cookware is uneven or embossed, this will reduce the heat supply.

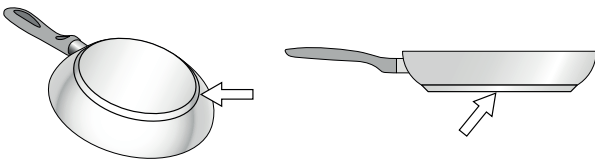

Cookware that has been removed or is of an unsuitable size

Always place items of cookware inside the usable area of the cooking surface. If the cookware is not positioned correctly, is made of an unsuitable material or is not the right size, the **▲** symbol will appear next to the cooking position display. Move the cookware or try again with a different pot or pan.

If you lift the "active" cookware from the cooking surface for more than 30 seconds, the cooking position automatically switches off.

Empty cookware or cookware with a thin base

Do not heat empty items of cookware and do not use cookware that has a thin base. The hob is equipped with an internal safety system. However, an empty item of cookware can heat up so quickly that the automatic switch-off function has no time to react and an excessively high temperature is reached. This could melt the base of the cookware and damage the glass plate. If this happens, switch off the hob and do not touch the cookware. If this no longer works once it has cooled down, contact our technical after-sales service.

Pan detection

The hob uses the ferromagnetic diameter and material of the base of the cookware to automatically detect the position, size and shape of the cookware being used. Cookware with a base measuring 90 to 340 mm in diameter is suitable for use.

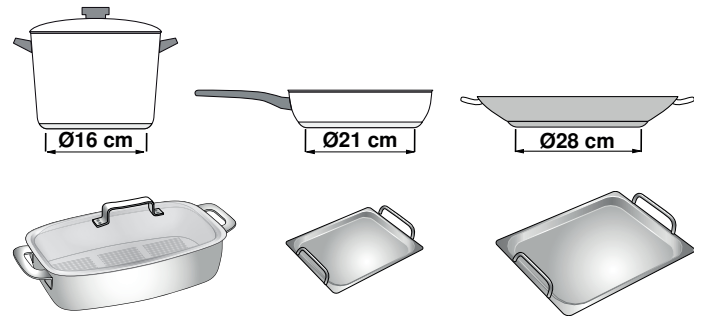

Note: The cooking position displays may show a size and shape that is different from the cookware actually being used. This is normal and does not affect the functioning of the hob. For more information, see the section entitled → "Frequently Asked Questions (FAQ)".

Getting to know your appliance

This section explains how to use the cooking surface, the control panel and the various different functions of the appliance.

Note: Depending on the appliance model, individual details and colours may differ.

Cooking surface

The entire cooking surface of the hob supplies induction heating. You can place items of cookware anywhere inside the usable area of the cooking surface. The position, size and shape of the cookware will be detected automatically.

Note: Up to 6 items of cookware can be heated at the same time on the cooking surface.

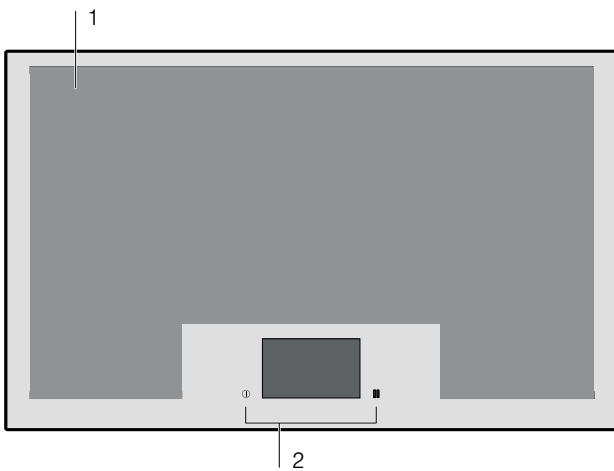

Hob

- | | |
|---|------------------------|
| 1 | Usable cooking surface |
| 2 | Control panel |

The control panel

The control panel has buttons and a touchscreen display.

Buttons







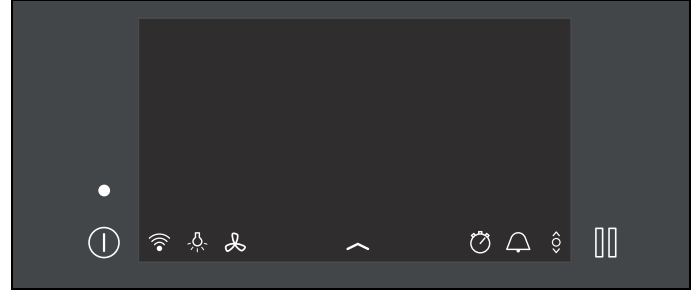













The buttons are touch-sensitive. To select a function, touch the relevant symbol. The available functions will appear in the display.

Notes

- Always keep the control panel clean and dry. Moisture can prevent it from working properly.
- Never place hot cookware on the touchscreen display. The electronics could overheat.



Selection sensors

	Main switch
	Wi-Fi
	Pause function
	Hood control light
	Hood control
	Docking menu
	Info menu
	Childproof lock
	Basic settings
	Stopwatch
	Timer
	powerMove Pro
Cooking modes menu	
	Power levels
	PowerMove Pro
	Cooking sensor
	Meal assistant
Cooking zone	
1.0-9.0	Power levels
	PowerBoost function
	ShortBoost function
	Keep-warm function
	Cooking timer

Touchscreen display

The touchscreen display gives you an overview of the cookware on the cooking surface and the buttons for activating the various functions.

When an item of cookware is set down on the cooking surface, the cooking position display for this cookware is shown on the display.

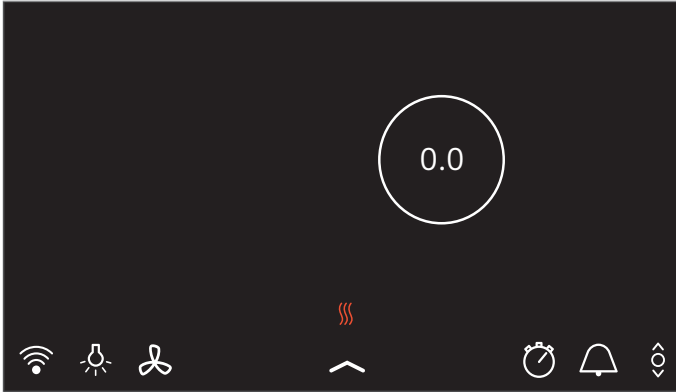

Overview of the menus

The intuitive menu structure helps you to find your way around the control panel of your hob. You can find out more about the most important menus in this section.

Main screen

The main display provides an overview of the indicators for the cookware on the cooking surface. It displays the cooking mode, power levels, and the timer functions that are set for the cooking zones that are switched on.

Settings area

Go to the settings area for a particular cooking position if you want to configure the heat settings, cooking times or the various cooking modes for this cooking position.

To bring up the settings area, touch the cooking position indicator you require.

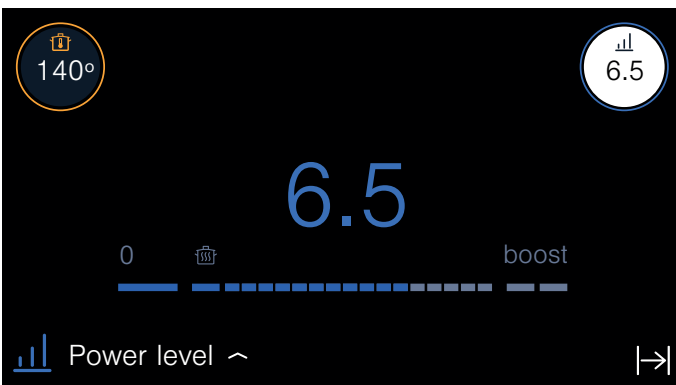

Status bar

You can access certain functions and other menus via the status bar.

The status bar shows the following options:

- Wi-Fi
- Hood control light
- Hood control
- Docking menu
- Stopwatch
- Basic settings
- powerMove Pro

Docking menu

You can access certain functions and further menus via the Docking menu.

To open the Docking menu, touch the symbol at the bottom of the main screen in the middle and swipe up.

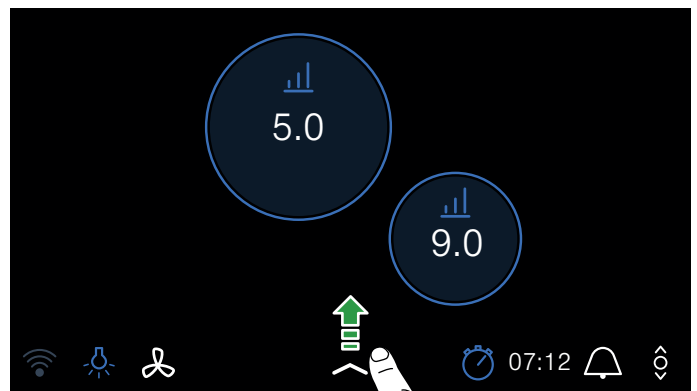

The Docking menu displays the following options:

- Info menu
- Childproof lock
- Basic settings

To close the Docking menu, touch the symbol again and swipe down.

Info menu

You can access information about the appliance using the Info menu.

To navigate to the Info menu, open the Docking menu and touch the symbol. The available options will be displayed.

To exit the Info menu, touch the symbol.





You can also access information about the functions you are currently using. To do this, touch the symbol for or the name of the function you require and hold it for a few seconds. On the display, an info window will appear that describes the current function.

Notifications and instructions

Shows information about a change in the appliance's status or notifies user when they need to do something. Follow the instructions in the display panel.

Cooking modes menu

The hob has a number of different cooking modes.

Cooking mode	Function
 Power levels	This enables you to select the power level for each item of cookware.
 powerMove Pro	This enables you to control a certain power level according to the position of the cookware by moving the cookware from front to back over the cooking surface.
 Cooking sensor	You can use the cooking sensor that is attached to the outside of the cookware to automatically keep the temperature at a set level. These functions are designed for foods that need to be cooked with a lot of water or fried with a lot of oil/fat in the pan. Note: This function will be ready to use once the wireless cooking sensor is connected to the control panel.
 Meal assistant	Cooking with food pre-selection

To navigate to the Cooking modes menu, select the cooking position and touch the active cooking mode.

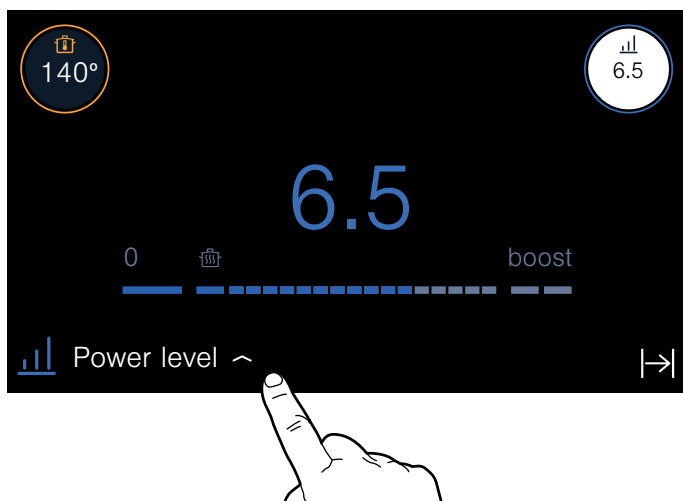

Cooking position display

When you place an item of cookware on the cooking surface, the indicator for the relevant cooking position will light up on the touchscreen display.

Cooking zone detected

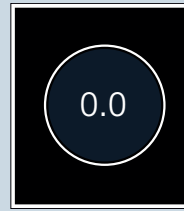

The cookware has been detected on the cooking zone. The cooking zone indicator lights up. Touch the indicator to select the cooking zone.

Selected cooking zone



The displayed cooking zone has been selected. You can set the power level.

The cooking zone is activated

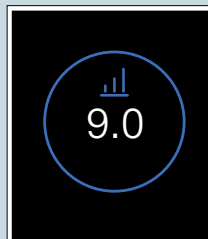

The displayed cooking zone has been activated. The selected power level lights up in the display.

There is no cookware on the cooking zone

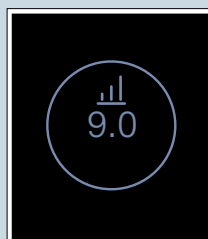

The cookware has been removed from the cooking zone. The previously selected power level changes colour.

Other indicators and symbols

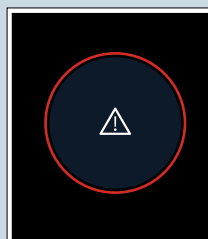

The selected cooking zone cannot be programmed.

Touch the  symbol in the status bar for more information.

Possible causes:

- You can cook with up to six items of cookware evenly distributed over the cooking surface at the same time.
- The cookware is not suitable for use on an induction hob.
- The appliance has exceeded its maximum power consumption.

Activate the active Light lighting.

The cooking surface has interactive light lines on the left and right of the hob. The light lines show the position of the cookware on the cooking surface and the status of the relevant cooking zone.

For instructions on how to activate or deactivate the light lines, see the section entitled → *"Basic settings"*

The following table shows the meanings of the different colours:

Colour	Meaning
White	The cookware on the cooking surface has been detected.
Blue	The segment of the cooking surface is activated.
Blue colour area	The powerMove Pro is activated. You can move the cookware along the blue light line.
Orange	Cooking sensor
Red	Residual heat indicator Note: If the red light strips on both sides of the cooking surface flash, an error has occurred.

Residual heat indicator

The hob has two residual heat indicators:

- Touch the ≡ symbol on the main screen. One, two or all three lines light up depending on the intensity of the residual heat.
- The brightness with which the red light strips light up indicates the intensity of the residual heat.

They indicate that the cooking surface is still hot. Do not touch the cooking surface while the indicators are still lit or immediately after they have gone out.

The residual heat indicators will remain lit for as long as the cooking surface is still hot, even after you switch the hob off.

Operating the appliance

This chapter explains how to set a cooking position. The table shows heat settings and cooking times for various meals.

First-time use

When you switch on the appliance for the first time, the menu for selecting the initial settings appears on the display. Select the settings you require.

Once you have confirmed these settings, the main screen will appear.

Note: You can change the settings at any time. For information on how to select these settings, see the section entitled → *"Basic settings"*.

Switching the hob on and off

The main switch is used to switch the hob on and off.

To switch the hob on: Touch the ① symbol. The indicator above the main switch lights up. After a short switch-on time, the hob will be ready for operation.

To switch the hob off: Touch the ① symbol. The display switches off. All the cooking positions are switched off.

The residual heat indicator will remain lit until the cooking positions have cooled down sufficiently.

Notes

- The hob will automatically switch off if the cooking positions have been switched off for more than 30 seconds.
- The settings are stored for 10 seconds after the hob has been switched off. If you switch the hob back on during this time, the option to confirm the previous settings will appear on the main screen. For information on this setting, see the section entitled → *"Basic settings"*.

Configuring cooking position settings

The required heat setting is selected in the settings area.

Heat setting 1.0	= lowest setting
Heat setting 9.0	= highest setting

Each heat setting has an intermediate setting ending in .5.

Notes

- To protect the fragile parts of your appliance from overheating and electrical overloading, the hob may temporarily reduce the power.
- In order to prevent the appliance from producing excess noise, the hob may temporarily reduce the power.

Selecting a cooking position and heat setting

The hob must be switched on.

1. Place the cookware on the cooking surface.
2. Touch the symbol for the cooking position you require to select the cooking position. The settings area for the cooking position you have selected will appear on the display panel.

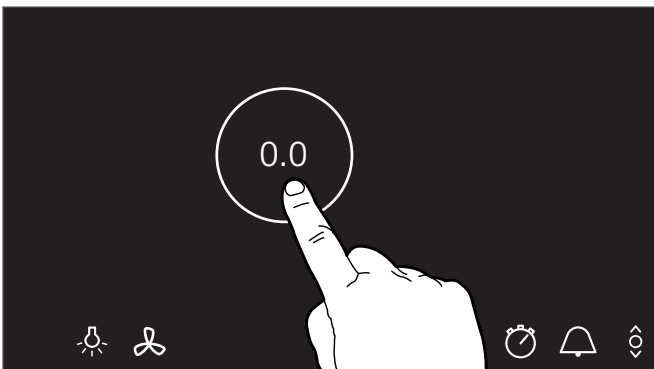

3. Swipe your finger over the settings area and touch the heat setting you require.

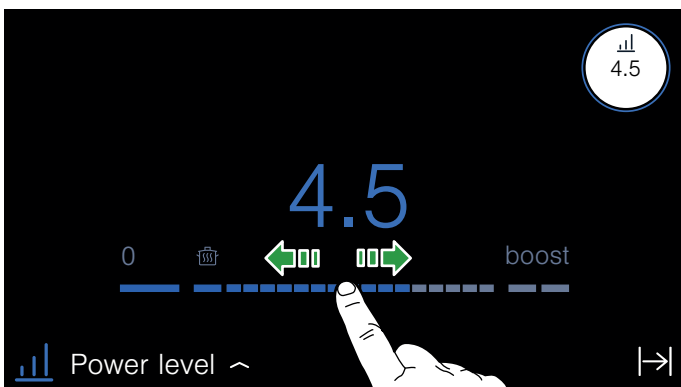

The heat setting is set.

Changing the heat setting

Select the cooking position and then set the required heat setting in the control panel.

Switching off a cooking position

Touch the cooking zone indicator on the main display until the power level **0.0** appears. The cooking zone switches itself off.

Note: If you place an item of cookware on the cooking surface before switching on the hob, this will be detected when you touch the main switch and the cooking position display will appear on the touchscreen display.

Chef's recommendations

Recommendations

- When heating up puree, cream soups and thick sauces, stir occasionally.
- Set heat setting 8 to 9 for preheating.
- When cooking with the lid on, turn the heat setting down as soon as steam escapes between the lid and the cookware. Steam does not need to escape for a good cooking result.
- After cooking, keep the lid on the cookware until you serve the food.
- To cook with the pressure cooker, observe the manufacturer's instructions.
- Do not cook food for too long, otherwise the nutrients will be lost. The kitchen clock can be used to set the optimum cooking time.
- For a more healthy cooking result, smoking oil should be avoided.
- To brown food, fry small portions in succession.
- Cookware may reach high temperatures while the food is cooking. We recommend that you use oven gloves.
- You can find recommendations for energy-efficient cooking in section → "Environmental protection"

Recommended dishes

The table shows which heat setting is suitable for each type of food. The cooking time may vary depending on the type, weight, thickness and quality of the food.

	Ongoing cooking setting	Time (mins)
Melting		
Chocolate, couverture	1.0 - 1.5	-
Butter, honey, gelatine	1.0 - 2.0	-
Heating or keeping warm		
Stew, e.g. lentil stew	1.5 - 2.0	-
Milk ¹	1.5 - 2.5	-
Parboiled sausages ¹	3.0 - 4.0	-
Defrosting and heating		
Spinach, frozen	3.0 - 4.0	15 - 25
Goulash, frozen	3.0 - 4.0	35 - 55
Poaching, simmering		
Potato dumplings ¹	4.5 - 5.5	20 - 30
Fish ¹	4.0 - 5.0	10 - 15
White sauces, e.g. Béchamel sauce	1.0 - 2.0	3 - 6
Whisked sauces, e.g. Béarnaise sauce, Hollandaise sauce	3.0 - 4.0	8 - 12
Boiling, steaming, braising		
Rice (with double the quantity of water)	2.5 - 3.5	15 - 30
Rice pudding ³	2.0 - 3.0	30 - 40
Unpeeled boiled potatoes	4.5 - 5.5	25 - 35
Boiled potatoes	4.5 - 5.5	15 - 30
Pasta ¹	6.0 - 7.0	6 - 10
Stew	3.5 - 4.5	120 - 180
Soups	3.5 - 4.5	15 - 60
Vegetables	2.5 - 3.5	10 - 20
Vegetables, frozen	3.5 - 4.5	7 - 20
Stew in a pressure cooker	4.5 - 5.5	-
Braising		
Rolled roasting joint	4.0 - 5.0	50 - 65
Pot roast	4.0 - 5.0	60 - 100
Goulash ³	3.0 - 4.0	50 - 60
¹ Without a lid		
² Turn frequently.		
³ Preheat at level 8.0–8.5.		

	Ongoing cooking setting	Time (mins)
Braising/frying with a small amount of oil ¹		
Escalope, plain or breaded	6.0 - 7.0	6 - 10
Escalope, frozen	6.0 - 7.0	6 - 12
Chops, plain or breaded ²	6.0 - 7.0	6 - 12
Steak (3 cm thick)	7.0 - 8.0	6 - 12
Poultry breast (2 cm thick) ²	5.0 - 6.0	10 - 20
Poultry breast, frozen ²	5.0 - 6.0	10 - 30
Rissoles (3 cm thick) ²	4.5 - 5.5	20 - 30
Hamburgers (2 cm thick) ²	6.0 - 7.0	10 - 20
Fish and fish fillet, plain	5.0 - 6.0	8 - 20
Fish and fish fillet, breaded	6.0 - 7.0	8 - 20
Fish, breaded and frozen, e.g. fish fingers	6.0 - 7.0	8 - 15
Prawns and scampi	7.0 - 8.0	4 - 10
Sautéing fresh vegetables and mushrooms	7.0 - 8.0	10 - 20
Asian-style stir-fries (vegetables and meat cut in strips)	7.0 - 8.0	15 - 20
Frozen dishes, e.g. stir-fries	6.5 - 7.5	6 - 10
Pancakes (cooked one after the other)	6.5 - 7.5	-
Omelette (cooked one after the other)	3.5 - 4.5	3 - 10
Fried eggs	5.0 - 6.0	3 - 6
Deep-frying ¹ (150-200 g per batch in 1-2 l oil, deep-fat fried in batches)		
Frozen products, e.g. chips, chicken nuggets	8.0 - 9.0	-
Croquettes, frozen	7.0 - 8.0	-
Meat, e.g. chicken portions	6.0 - 7.0	-
Fish, breaded or battered	6.0 - 7.0	-
Vegetables, mushrooms, breaded, beer-battered or tempura	6.0 - 7.0	-
Small baked items, e.g. doughnuts, beer-battered fruit	5.5 - 6.5	-
¹ Without a lid		
² Turn frequently.		
³ Preheat at level 8.0–8.5.		

Time-setting options

Your hob has three timer functions:

- Programming the cooking time
- Kitchen timer
- Stopwatch function

Cooking timer

The cooking position will switch off automatically once the time that is set has elapsed.

You can set a cooking time of up to 12 hours 59 minutes.

Setting procedure:

1. Select the cooking position and required power setting.
2. Touch the  symbol on the cooking zone's settings area.

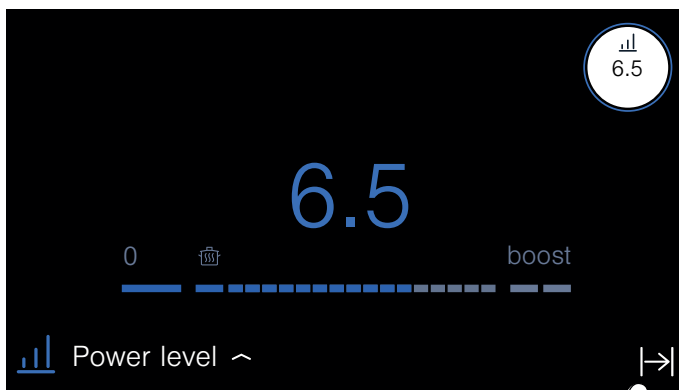

3. Set the time you require.
To set the number of hours, touch 00 h and select the time in the settings area.
To set the number of minutes, touch 00 min and select the time in the settings area.
The seconds appear above the minutes indicator.
You can set intervals of between 30 seconds and 5 minutes.

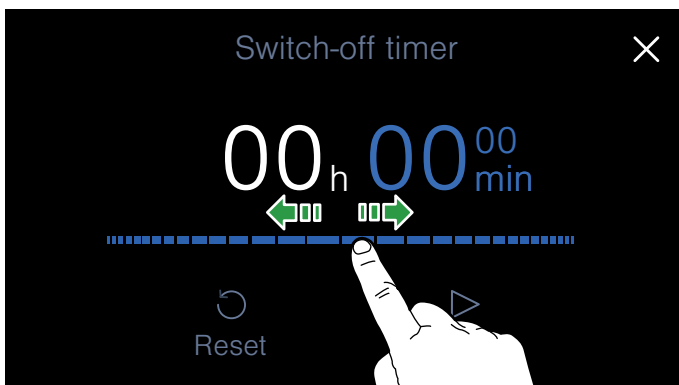

4. To confirm the selected time, touch the  symbol. The programmed time appears in the cooking zone display.

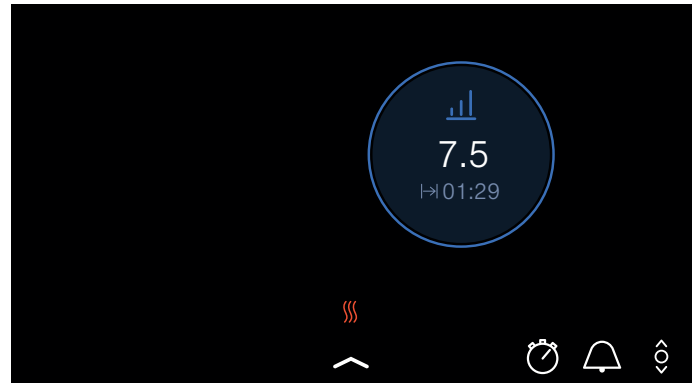



The cooking time begins to elapse.

Cooking sensor

When you set a cooking time for a cooking zone in which the cooking sensor is activated, the cooking time will not start counting down until the selected temperature level has been reached.

Changing or deleting the time

To navigate to the cooking time, touch the cooking zone indicator and then select the .

To change the cooking time, select a new cooking time and then touch .

To clear the time, touch .

To return to the main screen, touch .

When the time has elapsed

The cooking position will switch itself off. An audible signal will sound and the heat setting will be set to 0.0.

Touch the cooking position display to make the time disappear and stop the audible signal.

Short-term timer

You can set a time of up to 9 hours, 59 minutes and 59 seconds on the short-term timer.

You can activate it whether the hob is switched on or off.

It works independently of the cooking positions and other settings. This function does not automatically switch off a cooking position.

Setting procedure

1. Touch the 🔔 sensor.
2. Set the time you require.
To set the number of hours, touch 00 h and select the time in the settings area.
To set the number of minutes, touch 00 min and select the time in the settings area.
The seconds appear above the minutes indicator.
You can set intervals of between 30 seconds and 5 minutes.
3. Touch the ▶ symbol.

The time will now start to elapse.

After a few seconds, the time will appear on the main screen.

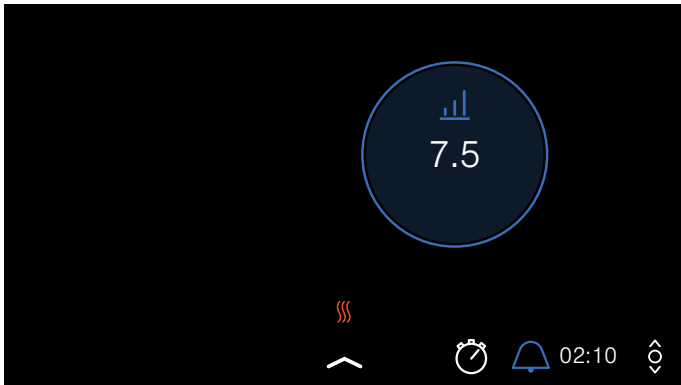

Changing or deleting the time

To activate the short-term timer, touch the 🔔 sensor

To change the cooking time, select a new cooking time and then touch ▶ Start.

To clear the time, touch ⌚.

To return to the main screen, touch ✕.

When the time has elapsed

An audible signal will sound once the time has elapsed, and a time of 00:00 will be displayed.

If you touch the 🔔 sensor, the time will disappear.

Stopwatch function

The stopwatch function displays the time that has elapsed since activation.

This functions independently from the cooking position and from other settings. This function does not automatically switch off a cooking position.

Activating

Touch the ⌚ symbol in the main area.

The time will begin to elapse.

Deactivating

To activate the short-term timer, touch the 🔔 sensor.

To clear the time, touch Reset ⌚.

To return to the main screen, touch the ← symbol.

PowerBoost function

The PowerBoost function enables you to heat up large quantities of water faster than when using heat setting 9.

If the Boost option is displayed in the settings area of the cookware, this function is available.

The powerBoost function is only available for one item of cookware on each side of the cooking surface.

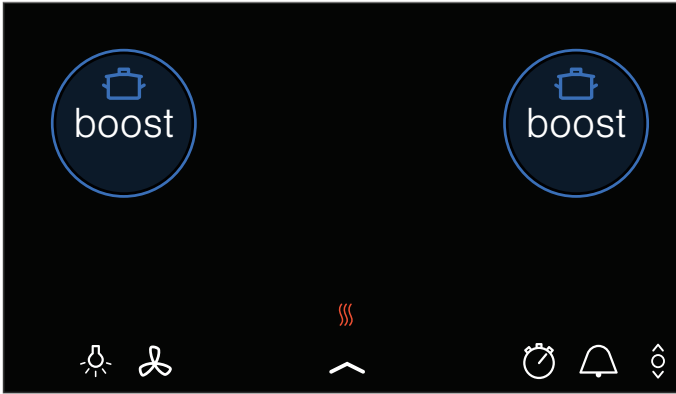

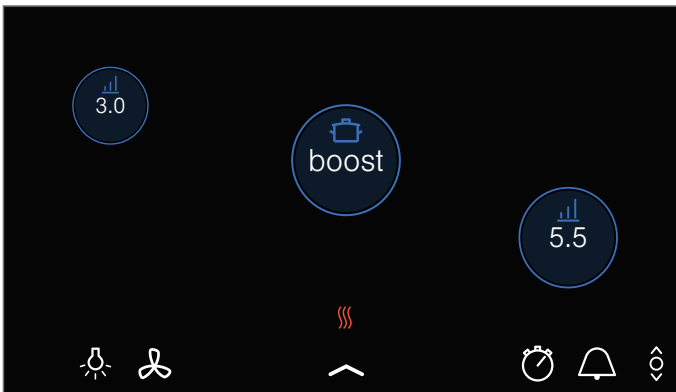

If the powerBoost function is activated and you configure the settings for a different cooking zone on the same side of the cooking surface, the powerBoost function will be deactivated and power level 9.0 selected automatically.

If the powerBoost function is activated, you can configure settings in the middle of the cooking surface for other items of cookware that are on both sides on the cooking surface.



Activation

1. Select a cooking position.
2. Set boost in the settings area. The  and  symbols will be lit.

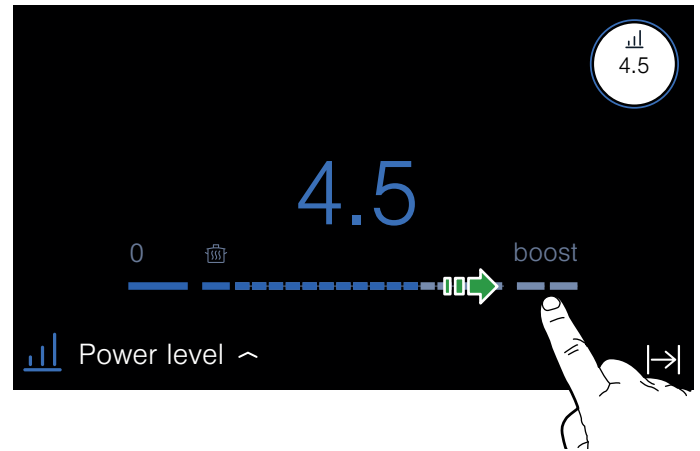

3. Select the  symbol.

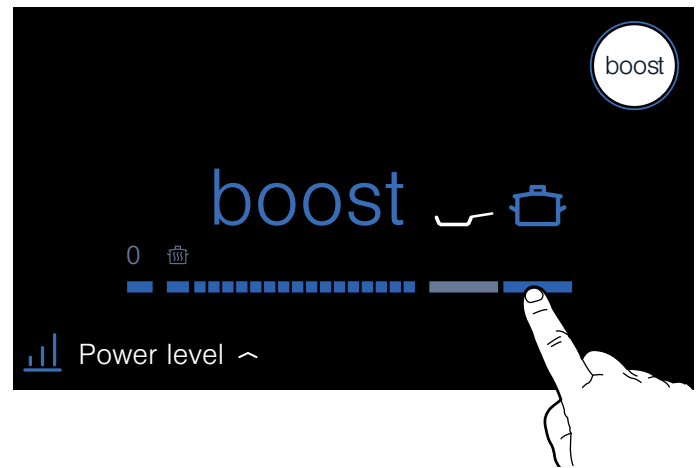

This function has now been activated.

Deactivating

Select the cooking position and set a different heat setting in the settings area.

This function has now been deactivated.

Note: In certain circumstances, the PowerBoost function can switch itself off automatically in order to protect the electronic elements inside the hob.

panBoost function

The panBoost function enables you to heat cookware faster than when using heat setting 9.

After deactivating the function, select the appropriate heat setting for your food.

If the Boost option is displayed in the settings area of the cookware, this function is available.

The panBoost function is only available for one item of cookware on each side of the cooking surface.

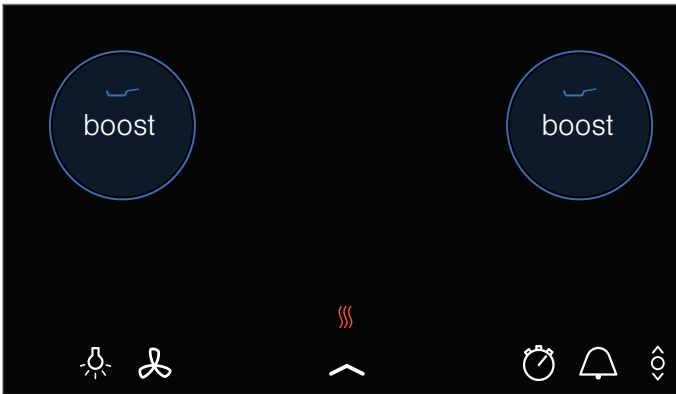

If the panBoost function is activated and you configure the settings for a different cooking zone on the same side of the cooking surface, the panBoost function will be deactivated and power level 9.0 selected automatically.

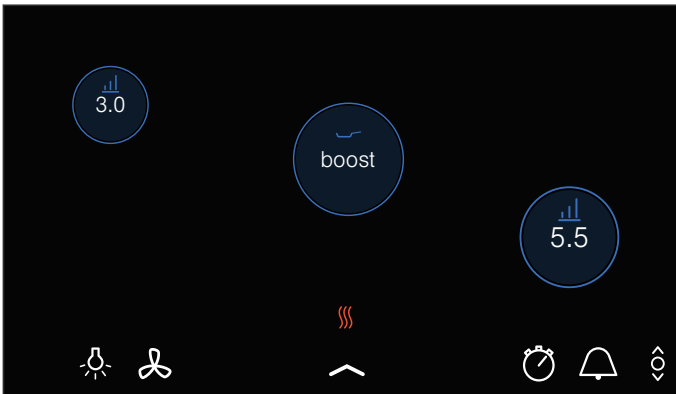

If the panBoost function is activated, you can configure settings in the middle of the cooking surface for other items of cookware that are on both sides on the cooking surface.



Recommendations for use

- Always use cold cookware.
- Use cookware with a fully flat base. Do not use cookware with a thin base.
- Never leave empty cookware, oil, butter or lard unattended when it is being heated.
- Do not place a lid on the cookware.
- For information on the type, size and positioning of the cookware, see the section entitled → "Induction cooking".

Activation

1. Select a cooking position.
2. Set boost in the settings area. The  and  symbols will be lit.

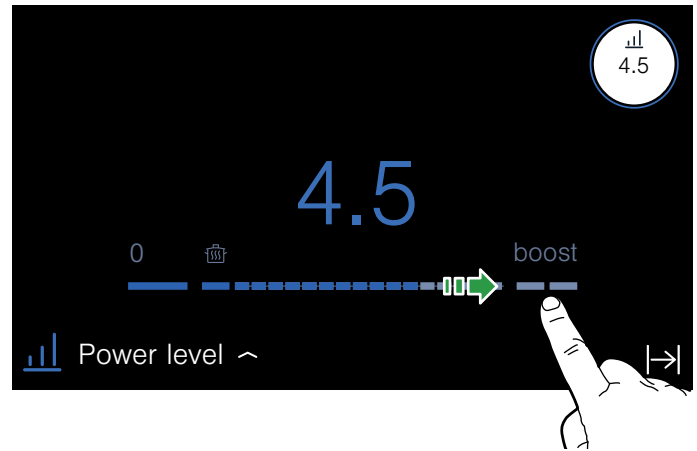

3. Select the  symbol.

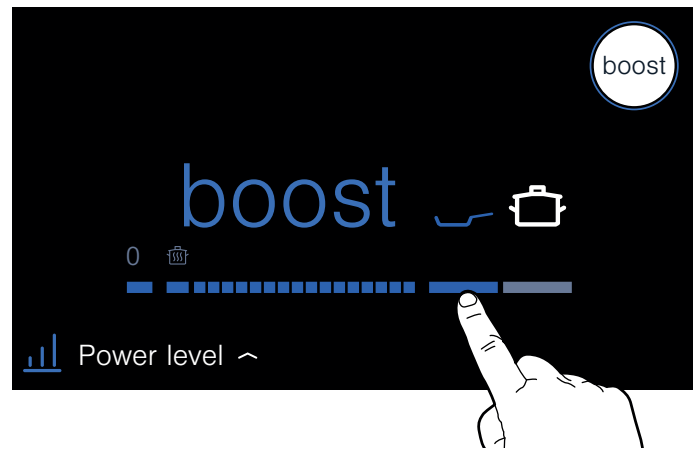

This function has now been activated.

Deactivating

Touch the cooking position display and select any power level in the settings area.

This function has now been deactivated.

Note: After 30 seconds, this function automatically switches itself off. The cooking position automatically switches back to power level 9.0.

Keep warm function

This function is suitable for melting chocolate or butter and for keeping food warm.

Activation

1. Select a cooking position.
2. Select the first setting in the settings area. The  indicator will be lit.

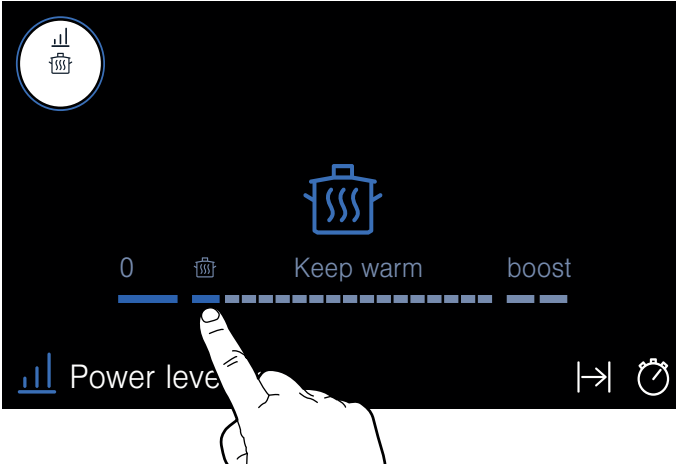

This function has now been activated.

Deactivating

1. Select the cooking position.
 2. Select a different power level in the settings area. The  indicator goes out.
- This function has now been deactivated.

Transferring settings

This function lets you transfer the selected power level or temperature setting and the cooking time from one cooking position to another.

If you remove an item of cookware from the cooking surface or move it, the cooking position it was previously on stops heating. The settings for the cooking position will be retained for 30 seconds.

When you place the cookware back in this position, the same settings will be used.

Activation

1. Place an item of cookware on the cooking surface.

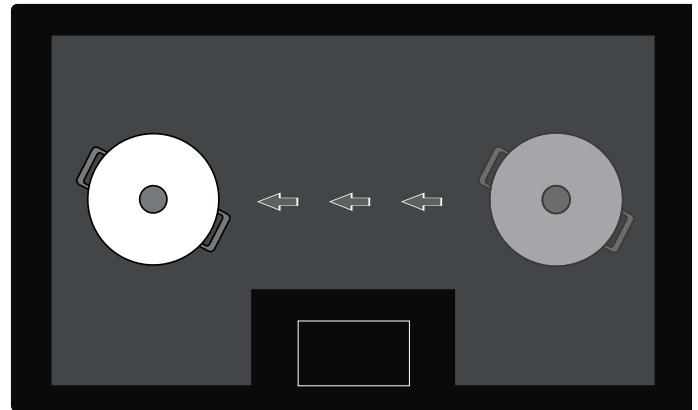

The cooking zone display shows the new position of the cookware with power level.

2. Touch Apply confirm transferral of the settings.

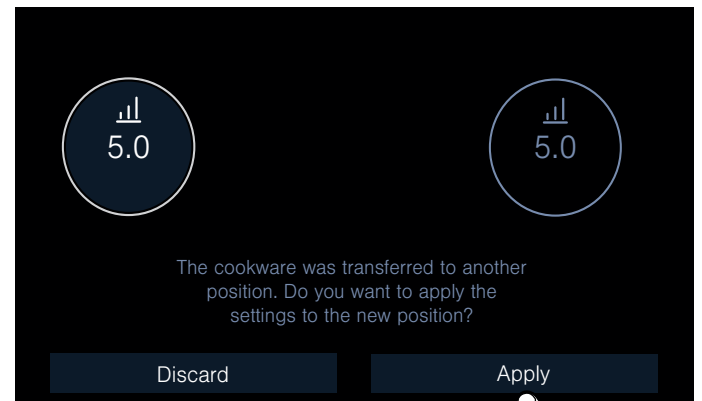

The settings have been transferred to the new cooking position.

Wireless temperature sensor

Connect the wireless cooking sensor to the control panel before using the cooking sensor functions for the first time.

Preparing and maintaining the wireless temperature sensor

This section provides information on:

- Attaching the silicone patch
- Attaching the wireless cooking sensor
- Cleaning
- Replacing the battery

The silicone patch and temperature sensor can be purchased from specialist retailers or through our technical after-sales service or our official website. To do this, quote the relevant reference number:

00577921	Set of 5 silicone patches
HZ39050	Temperature sensor and set of 5 silicone patches

Adhering the silicone patch

The silicone patch attaches the wireless cooking sensor to the cookware.

If you are using an item of cookware with cooking sensor functions for the first time, attach the silicone patch directly to it. Proceed as follows:

1. That the adhesive area on the pan is free from grease. Clean the pan, dry it thoroughly and wipe the adhesive area with a spirit.
2. Remove the protective film from the silicone patch. Adhere the silicone patch to the outside of the pan in the correct place using the enclosed template as a guide.

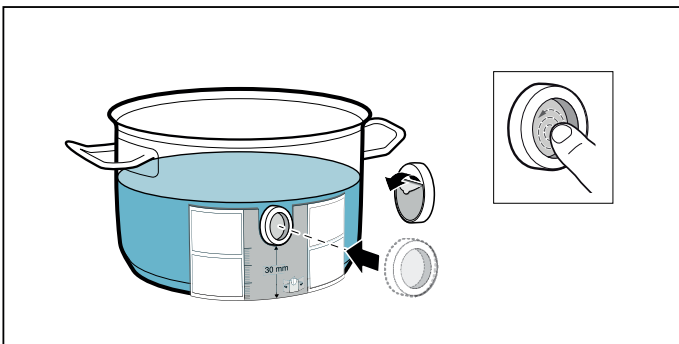

3. Press down all over the surface of the silicone patch, including in the centre. The adhesive requires one hour to fully harden. Do not use or clean the pan during this time.

Notes

- Do not leave the pan with the silicone patch to soak soapy water for long periods of time.
- If the silicone patch comes off, attach a new one.

Fitting the wireless temperature sensor

Attach the temperature sensor to the silicone patch and align it correctly.

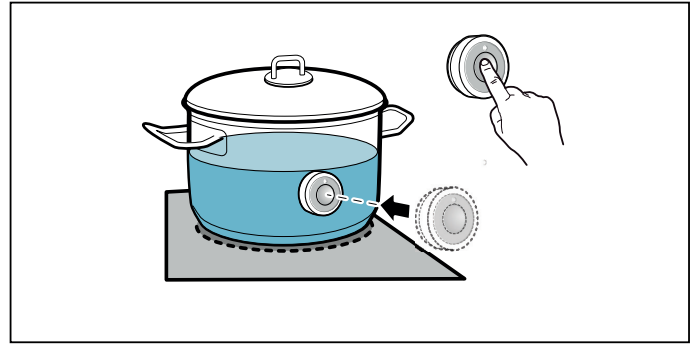

Notes

- Ensure that the silicone patch is completely dry before attaching the cooking sensor.
- Fill the pot so that the contents reach high enough to cover the cooking sensor's silicone patch.
- To prevent overheating, do not attach the cooking sensor to other hot cookware.
- Remove the cooking sensor from the pot after cooking. Store it in a clean, safe place away from sources of heat.
- You can use up to three cooking sensors at the same time.

Connecting the wireless temperature sensor to the control panel

To connect the wireless temperature sensor to the control panel, follow the instructions below:

1. Open the docking menu.
2. Open the basic settings and select "Cooking sensor" from the menu.
3. Select the Add a new cooking sensor option. Press the  symbol on the wireless temperature sensor within 30 seconds. After a few seconds, the status of the connection between the temperature sensor and the control panel will appear on the display.

The cooking sensor functions are made available once the wireless cooking sensor has been connected to the control panel correctly.

Notes

- A faulty connection due to the wireless cooking sensor not being detected may be caused by the following:
 - Bluetooth communication error.
 - You did not press the symbol on the wireless cooking sensor within 30 seconds.
 - The battery in the wireless cooking sensor is almost flat.
 Reset the wireless cooking sensor and repeat the connection procedure.
- If there are problems with the connection due to a transmission error, repeat the connection procedure. If you continue to experience connection problems, contact our technical after-sales services.

Resetting the wireless temperature sensor

1. Touch the  symbol on the cooking sensor for approximately 8-10 seconds. While you are doing this, the temperature sensor's LED indicator will light up three times. When the LED lights up for the third time, it will start to reset the temperature sensor. Stop touching the symbol when this happens. Once the LED goes out, this means that the wireless temperature sensor has been reset.
2. Repeat the connection procedure.

Cleaning

Do not clean the wireless temperature sensor in the dishwasher.

Temperature sensor

Clean the temperature sensor with a damp cloth. Never clean it in the dishwasher. Do not immerse it in water or clean it under running water.

Remove the temperature sensor from the saucepan after cooking. Store it in a clean, safe place (such as in its packaging) away from sources of heat.

Silicone patch

Clean and dry before attaching to the temperature sensor. Dishwasher safe.

Note:

Cookware with the silicone patch must not be left to soak for long periods in soapy water.

Temperature sensor window

The sensor window must always be clean and dry. Proceed as follows:

- Remove dirt and oil splatters regularly.
- Use a soft cloth or cotton buds and window cleaner for cleaning.

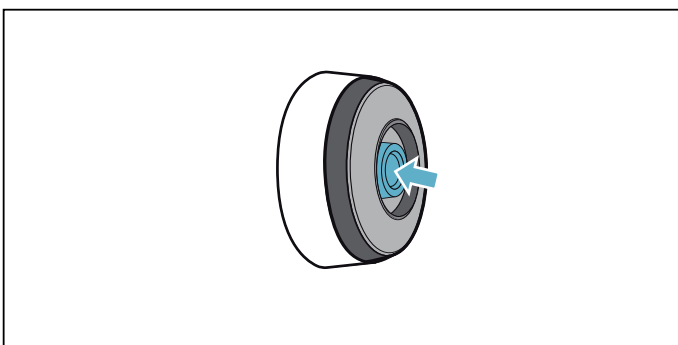

Notes

- Do not use abrasive cleaning agents such as scouring pads, scrubbing brushes or cream cleaners.
- Do not touch the sensor window with your fingers. This may make it dirty or scratch it.

Changing the battery

If the temperature sensor does not light up when the symbol is pressed, the battery is flat.

Changing the battery:

1. Remove the silicone cover from the lower section of the temperature sensor housing and remove both screws using a screwdriver.

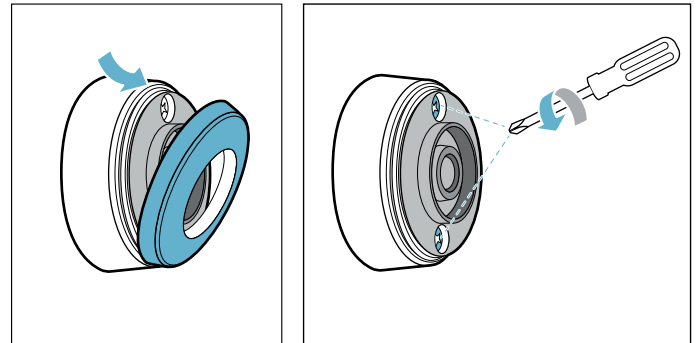

2. Open the closure of the temperature sensor. Remove the battery from the lower section of the housing and insert a new battery (pay attention to the correct orientation of the battery poles).

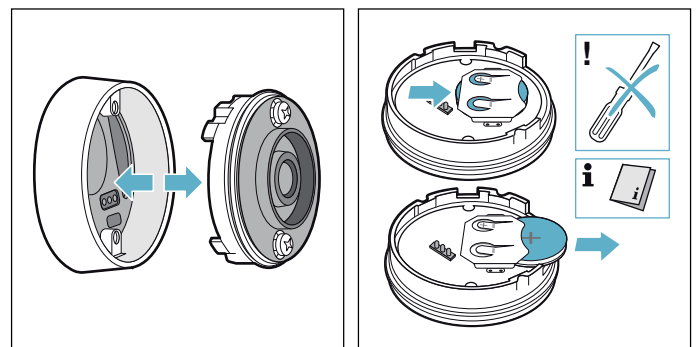

Caution!

Do not use any metal objects to remove the battery. Do not touch the battery connection points.

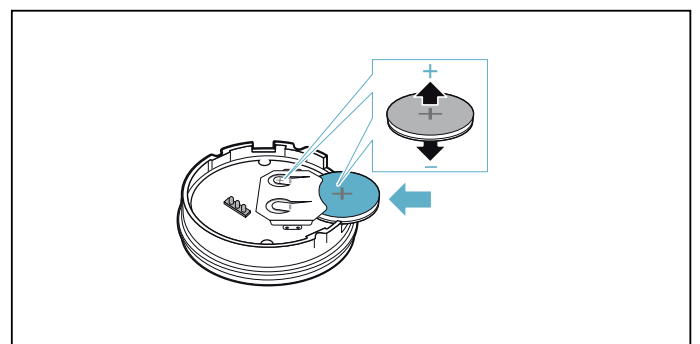

3. Close the closure of the temperature sensor (the notches for the screws on the closure must align with the notches on the lower section of the housing). Tighten the screws with a screwdriver.

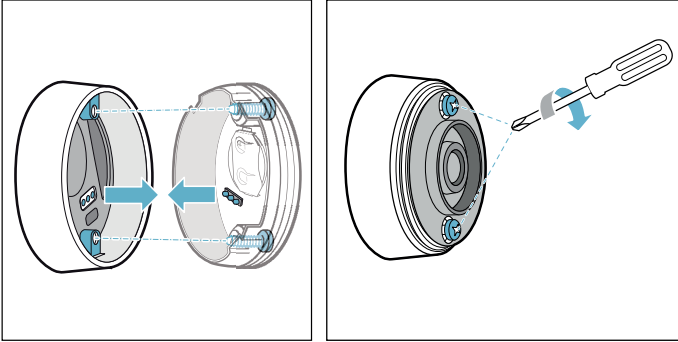

4. Reattach the silicone cover to the lower section of the temperature sensor housing.

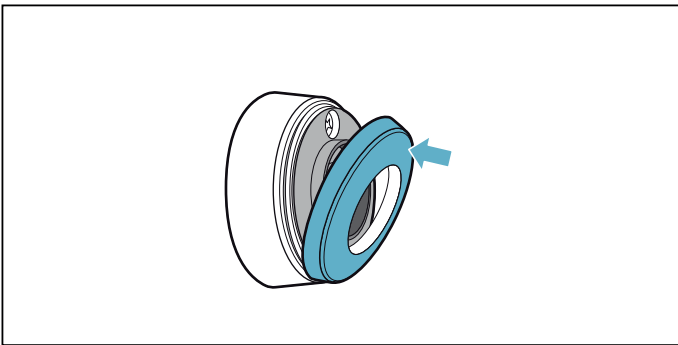

Note:

Use only high-quality batteries of the type CR2032 in order to guarantee a long service life.

Declaration of Conformity

BSH Hausgeräte GmbH hereby declares that the appliance with wireless temperature sensor function meets the basic requirements and other relevant provisions of the Directive 2014/53/EU.

A detailed RED Declaration of Conformity can be found online at www.siemens-home.bsh-group.com on the product page of your appliance with the additional documents.

The logos and the Bluetooth® brand are registered trademarks and property of Bluetooth SIG, Inc. These trademarks are used by BSH Hausgeräte GmbH under licence. All other trademarks and brand names are owned by the respective companies.

Cooking sensor

The cooking sensor is guaranteed to make cooking simple and it promises outstanding cooking results.

The wireless cooking sensor continuously measures the temperature of the cookware. This allows cooking to be precisely regulated and the temperature to be maintained at the required level at all times in order to prevent excessively vigorous boiling and to achieve perfect cooking results.

Add your food once the selected temperature has been reached. The temperature is automatically kept constant without you having to change the temperature level.

Provided there is a wireless cooking sensor, the cooking sensor is available over the entire cooking surface.

The wireless cooking sensor forwards the temperature of the cookware to the control panel.

The hob has a wireless cooking sensor. If necessary, you can purchase this retroactively from specialist retailers, via our technical after-sales service or in our online shop. You can use up to three cooking sensors at the same time.







Note: The cooking sensor can be ordered by quoting the reference number HZ39050.

For more information on the cooking sensor, see the section entitled → *"Wireless temperature sensor"*.

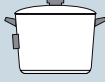
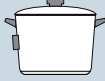
Cooking processes with the cooking sensor

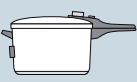
You can use the cooking sensor to select the best cooking type for each kind of food.

The table shows the available cooking processes:

Cooking processes	Temperature	Cookware	Suitable for
Keeping warm, heating	70 °C		E.g. punch, goulash
Poaching in milk	85 °C		E.g. panna cotta, rice pudding
Poaching in water	90 °C		E.g. rice, quinoa
Boiling	100 °C		E.g. pasta, gnocchi, vegetables
Cooking in a pressure cooker	115 °C		E.g. home-made broths, pulses
Deep-frying at a low temperature*	160 °C		E.g. doughnuts, fritters
Deep-frying at a medium temperature*	170 °C		E.g. breaded fish, meatballs
Deep-frying at a high temperature*	180 °C		E.g. chips, frozen

*Preheat with the lid on and deep-fry with the lid off.

Benefits

- The cooking zone only emits heat when this is necessary to maintain the temperature. This saves energy.
- The temperature is continuously monitored. This means that the food will not spill over and you do not need to change the temperature level.
- The cooking sensor detects when the water or the oil has reached the optimum temperature for adding the food (foods that should be added at the start of cooking are indicated in the table).

Notes

- Use cookware with a thick, flat base. Do not use cookware with a thin or deformed base.
- Fill the item of cookware so that the contents reach high enough to cover the cooking sensor's silicone patch.
- Do not remove the wireless cooking sensor from the cookware during cooking.
- After cooking, remove the wireless sensor from the cookware. Take care when doing so because the wireless cooking sensor may be very hot.

Tips for cooking with the cooking sensor

- Keeping warm/heating: Portions of frozen products, e.g. spinach. Place the frozen product in the cookware. Add the volume of water specified by the manufacturer. Cover the cookware with a lid. Select the temperature recommended in the table.
- Poaching: This cooking method is suitable for cooking food at low temperatures, thickening sauces, reducing stews and cooking with milk. Select the temperature recommended in the table for the food you want to cook.
- Boiling: This cooking method allows you to boil water with a lid on without it boiling over. This temperature control allows water to be boiled more efficiently. Select the temperature recommended in the table.
- Cooking in a pressure cooker: Follow the manufacturer's recommendations. After the signal tone sounds, continue cooking for the recommended time. Select the temperature recommended in the table.
- Deep-fat frying: It is recommended that you heat oil with a lid on. Once the signal tone has sounded, remove the lid and add the food. Select the temperature recommended in the table for the food you want to cook.

Notes

- Always cook with a lid, except when using the deep-frying function.
- If no signal sounds, make sure that there is a lid on the cookware. If there is a lid on the pan and still the signal doesn't sound, the appliance may have reached its maximum power consumption or the Maximum power consumption setting may have been activated. This may affect the time required to reach the selected temperature. Switch off or reduce the power levels for the other pots and pans. See the section entitled → "Basic settings"
- Never leave oil unattended when it is being heated. Use oil that is suitable for deep-frying. Do not mix different cooking fats and oils – e.g. oil and lard – as such mixtures may foam up when hot.
- If you are not satisfied with the cooking result, e.g. when cooking potatoes, next time use less water but keep the recommended temperature level.



Setting the boiling point

The point at which water starts to boil depends on the height of your home above sea level. If the water is boiling too vigorously or not vigorously enough, you can set the boiling point. Proceed as follows:

- Open the Docking menu and touch the  symbol. Go to the basic setting Set the boiling point.
- The default basic setting is 200–400 m. If your home is located at a height of between 200 and 400 metres above sea level, do not set the boiling point. Select the setting that matches your home's height above sea level.

Note: The temperature level 100 °C is sufficient for efficient boiling, even if the water does not boil very strongly. You can always change the boiling point if you wish – if you want the water to boil more strongly, for example, you can select a lower altitude.

Setting procedure

1. Attach the cooking sensor to the saucepan; see the section entitled
2. Fill the cookware with a sufficient amount of liquid, put the lid on and place it on the cooking surface. See the section entitled → *"Fitting the wireless temperature sensor"*.
3. Touch the cooking position display for the cookware.
4. Touch the active cooking mode and select the  Cooking sensor option.
Note: The cooking sensor is only available if the wireless cooking sensor is connected to the control panel. See the section entitled → *"Wireless temperature sensor"*
5. Touch the  symbol for the wireless temperature sensor.
6. Select the temperature level.
The function has now been activated.
The cooking position indicator and the selected temperature flash until the selected temperature has been reached. A signal then sounds.
7. When the signal tone sounds, remove the lid and add the food. Leave the lid on while cooking.

Tip: If you want to set the temperature more precisely, you can increase or decrease this by 1 °C to 5 °C. To do this, touch the selected temperature and then touch the  symbol.

Then select the required temperature.

To cancel and exit the menu, touch the  symbol.

Recommended dishes

The following table shows a selection of dishes and is arranged by food type. The temperature and the cooking time depend on the amount, the condition and the quality of the food.

Meat	Temperature	Time (mins)
Poaching		
Sausages ¹	90 °C	10 - 20
Boiling		
Meatballs ¹	100 °C	20 - 30
Chicken ¹	100 °C	60 - 90
Veal ¹	100 °C	60 - 90
Cooking in a pressure cooker		
Chicken in a pressure cooker ²	115 °C	15 - 25
Veal in a pressure cooker ²	115 °C	15 - 25
Deep-frying		
Deep-frying chicken portions ³	170 °C	10 - 15
Deep-frying meatballs ³	170 °C	10 - 15
¹ Pre-heat and cook with the lid on. Add the food when the audible signal sounds.		
² Add the food at the start.		
³ Heat the oil with the lid on. Fry one portion after the other without the lid.		

Fish	Temperature	Time (mins)
Poaching		
Braised fish ¹	90 °C	15 - 20
Deep-frying		
Deep-frying battered fish ²	170 °C	10 - 15
Deep-frying breaded fish ²	170 °C	10 - 15
¹ Pre-heat and cook with the lid on. Add the food when the audible signal sounds.		
² Heat the oil with the lid on. Fry one portion after the other without the lid.		

Egg dishes	Temperature	Time (mins)
Boiling		
Boiled eggs ¹	100 °C	5 - 10
¹ Add the food at the start		

Vegetables and pulses	Temperature	Time (mins)
Boiling		
Broccoli ¹	100 °C	10 - 20
Cauliflower ¹	100 °C	10 - 20
Spinach ¹	100 °C	5 - 10
Brussels sprouts ¹	100 °C	30 - 40
Green beans ¹	100 °C	15 - 30
Chickpeas ²	100 °C	60 - 90
Peas ¹	100 °C	15 - 20
Lentils ²	100 °C	45 - 60
Cooking in a pressure cooker		
Vegetables in a pressure cooker ²	115 °C	3 - 6
Chickpeas in a pressure cooker ²	115 °C	25 - 35
Haricot beans in a pressure cooker ²	115 °C	25 - 35
Lentils in a pressure cooker ²	115 °C	10 - 20
Deep-frying		
Deep-frying breaded vegetables ³	170 °C	4 - 8
Deep-frying battered vegetables ³	170 °C	4 - 8
Deep-frying breaded mushrooms ³	170 °C	4 - 8
Deep-frying battered mushrooms ³	170 °C	4 - 8
¹ Pre-heat and cook with the lid on. Add the food when the audible signal sounds.		
² Add the food at the start.		
³ Heat the oil with the lid on. Fry one portion after the other without the lid.		

Potatoes	Temperature	Time (mins)
Poaching		
Cooking potato dumplings ¹	85 °C	30 - 40
Boiling		
Gnocchi ¹	100 °C	3 - 6
Boiling potatoes ²	100 °C	30 - 45
Boiling sweet potatoes ²	100 °C	30 - 45
Cooking in a pressure cooker		
Potatoes in a pressure cooker ²	115 °C	10 - 20
Sweet potatoes in a pressure cooker ²	115 °C	10 - 20
Deep-frying		
Potatoes with a spicy sauce ³	160 °C	8 - 12
¹ Pre-heat and cook with the lid on. Add the food when the audible signal sounds.		
² Add the food at the start.		
³ Heat the oil with the lid on. Fry one portion after the other without the lid.		

Pasta and cereals	Temperature	Time (mins)
Poaching		
Semolina pudding ³	85 °C	5 - 10
Parboiled rice ¹	90 °C	25 - 35
Brown rice ²	90 °C	45 - 55
Exotic rice (e.g. basmati, Thai) ²	90 °C	8 - 12
Wild rice ²	90 °C	20 - 30
Quinoa ¹	90 °C	10 - 12
Polenta ³	85 °C	3 - 8
Boiling		
Durum wheat pasta ³	100 °C	7 - 10
Fresh pasta ³	100 °C	3 - 5
Wholemeal pasta ³	100 °C	7 - 10
Durum wheat pasta, filled ³	100 °C	15 - 20
Fresh pasta, filled ³	100 °C	5 - 8
Cooking in a pressure cooker		
Rice in a pressure cooker ²	115 °C	6 - 8
Brown rice in a pressure cooker ²	115 °C	12 - 18
¹ Pre-heat and cook with the lid on. Add the food when the audible signal sounds. ² Add the food at the start. ³ Stir frequently.		

Soups	Temperature	Time (mins)
Poaching		
Instant creamy soups ²	90 °C	10 - 15
Boiling		
Home-made broths ¹	100 °C	60 - 90
Instant soups ²	100 °C	5 - 10
Cooking in a pressure cooker		
Home-made broths in a pressure cooker ¹	115 °C	20 - 30
¹ Add the food at the start. ² Stir frequently.		

Desserts	Temperature	Time (mins)
Poaching		
Rice pudding ³	85 °C	40 - 50
Porridge ³	85 °C	10 - 15
Chocolate pudding ³	85 °C	3 - 5
¹ Add the food at the start. ² Heat the oil with the lid on. Fry one portion after the other without the lid. ³ Stir frequently.		

Desserts	Temperature	Time (mins)
Boiling		
Compote ¹	100 °C	15 - 25
Deep-frying		
Deep-frying jam-filled doughnuts ²	160 °C	5 - 10
Deep-frying ring doughnuts ²	160 °C	5 - 10
Deep-frying cream puffs ²	160 °C	5 - 10
¹ Add the food at the start. ² Heat the oil with the lid on. Fry one portion after the other without the lid. ³ Stir frequently.		

Frozen products	Temperature	Time (mins)
Keeping warm, heating		
Vegetables in a creamy sauce ⁴	70 °C	15 - 20
Defrosting broths ²	70 °C	15 - 25
Boiling		
Green beans, frozen ¹	100 °C	15 - 30
Deep-frying		
Deep-frying chips ³	180 °C	4 - 8
¹ Pre-heat and cook with the lid on. Add the food when the audible signal sounds. ² Add the food at the start. ³ Heat the oil with the lid on. Fry one portion after the other without the lid. ⁴ Stir frequently.		

Other	Temperature	Time (mins)
Keeping warm, heating		
Heating goulash soup ¹	70 °C	10 - 20
Heating mulled wine ¹	70 °C	5 - 15
Poaching		
Heating milk ¹	85 °C	3 - 10
¹ Add the food at the start.		

Meal assistant

This function can be used to cook a wide variety of food. The appliance will choose the optimal setting for you.

Activation

1. Select a cooking position.
2. Touch the active cooking mode and select the Meal assistant option.
3. Select the required food category.
4. Select the required meal.

You will be guided through the entire setting process for the selected meal and given instructions on how to prepare this meal.

Deactivating

Set the temperature to 0 or select a different cooking mode.

powerMove Pro

This function allows you to change the power level during cooking simply by moving the cookware forwards or backwards.

Activating this function will display the preset power levels for the item of cookware. You can select one of five available power levels depending on the position of the cookware.

Default power levels: , **3.0**, **5.0**, **7.0** and **9.0**.

For information on how to change the preset power levels, see the section entitled → "Basic settings".

Note: If the function does not activate when you select the power level, the appliance may have reached its maximum power consumption. For information on how to set the Maximum power consumption function, see the section entitled → "Basic settings".

Activation

Place the cookware on the cooking surface.

1. Touch the  symbol in the main view.

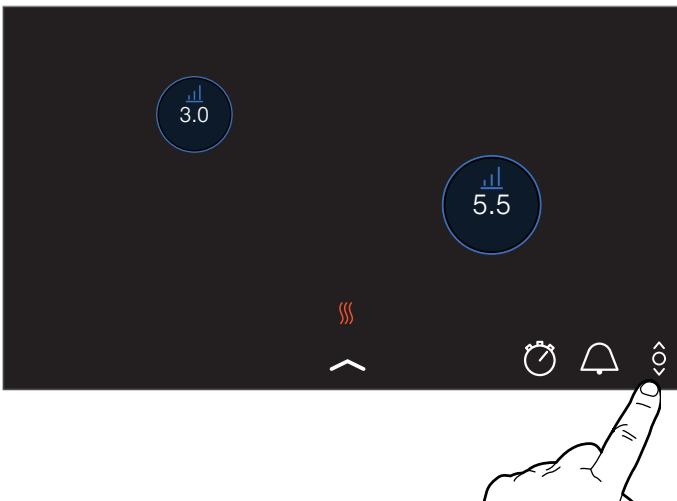

2. Touch the required cooking zone indicator.

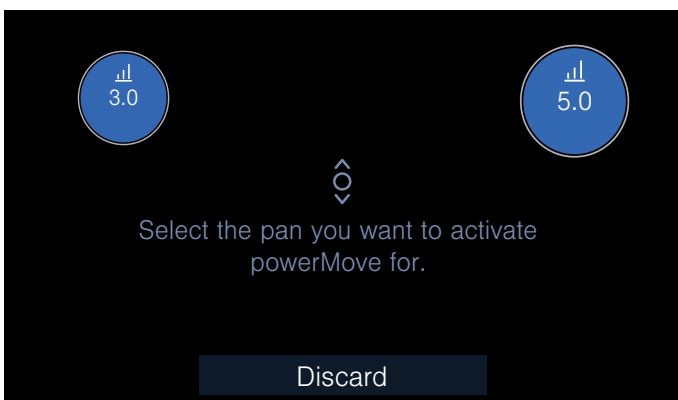

The function has now been activated.

3. Move the cookware over the cooking surface until the power level you require is set. The power level you have selected will appear on the cooking position display.

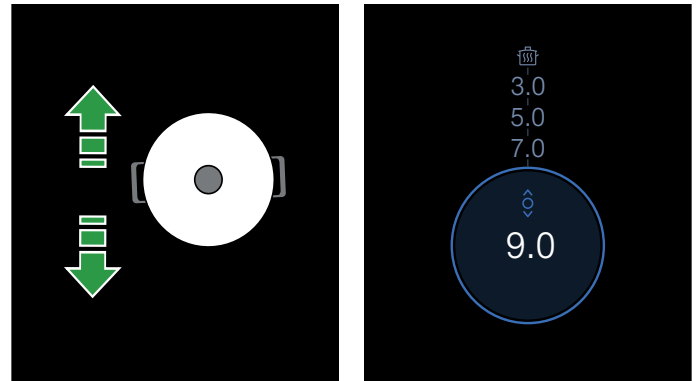

Notes

- If the function is not available for the cookware you want to use, an audible signal will sound and the function will not be activated.
- If the function is not available for any of the cookware you have set down, the  symbol will not appear on the main display.

Changing the heat setting

You can change the power levels while you are cooking. To choose a different power level in the programming area, touch the area you want to change the power level of.

Note: If the function is deactivated, the power levels will return to the default values

Deactivating

Touch the cooking zone indicator on the main display until the power level **0.0** appears. The cooking zone switches itself off.

This function has now been deactivated.

Childproof lock

You can use the childproof lock to prevent children from switching on the hob.

Activating and deactivating the childproof lock

All cooking zones must be switched off.

Activation

1. Open the docking menu.
2. Touch the  symbol.
The childproof lock is now activated. The hob is now locked.

Deactivating

Follow the instructions on the display panel.

The lock is now released.

Childproof lock

With this function, the childproof lock automatically activates when a hob is switched off.

Switching on and off

You can find out how to switch the automatic childproof lock on in the → *"Basic settings"* section

Pause

The selected settings are retained while the pause function is activated, but no power level is used and the cooking times that have been set will stop.

If you have activated the alarm or the timer, it will continue running. You cannot change the alarm time when the pause function is activated.

The pause function has no effect on the main switch. You can still switch off the hob at any time.

Activation

Touch the  symbol. The hob will remain locked for 30 minutes. You can now clean the surface of the touchscreen display, for example, without inadvertently changing the settings.

Deactivating

To deactivate the function before 30 minutes have passed, touch the  symbol and then touch Continue.

The hob will switch off automatically after 30 minutes.

Note: If you move the cookware across the cooking surface while the function is still activated, the settings may be lost.

Automatic safety cut-out

If a cooking zone operates for an extended period and no settings are changed, the automatic safety switch-off is activated.

This stops the cooking zone from heating up. A notification will appear on the display.

Touching any symbol will switch off the display. The cooking zone can now be reset.

The point at which the automatic safety switch-off becomes active depends on the power setting in use (after 1 to 10 hours).

Basic settings

The appliance has various basic settings. You can adapt these settings to your personal requirements.

Settings	Description and options
Language	You can change the language of the appliance.
Home Connect	Using this function, you can connect your appliance to your home network and a mobile end device.
Hood control cookConnect	You can use this to control important functions of your cooker hood via your hob, e.g. the fan speed and light.
Signal tones	You can select which signal tones the appliance should sound.
Signal duration	You can change the duration of the signal tones.
Signal volume	Set the volume of the audible signals.
Button tone	You can choose whether or not the appliance will sound when fields and symbols are touched on the touchscreen.
Touch field tone volume	Set the volume for when you touch a sensor.
Display brightness	You can change the brightness of the display.
activeLight	Activate or deactivate activeLight.
Childproof lock	You can use the child safety lock to lock the hob and prevent children from using it without supervision.
reStart	You can set how long your appliance saves the most recently used settings after it has been switched off.
Max. power consumption	You can restrict the hob's total power and adapt it to the local mains connection.
Cooking sensor	You can add a new temperature sensor.
Set the boiling point	You can enter your height above sea level to improve the cooking sensor's accuracy.
powerMove Pro power levels	The preset settings for the powerMove Pro function can be changed.
Appliance info.	You can view information about your appliance.
Factory settings	You can reset all the settings to the factory settings.

To go to the basic settings:

Open the docking menu and touch the  symbol. All cooking position must be switched off.

Basic settings menu

Slide your finger up or down to scroll through the available settings. Touch a setting to access further options in its sub-menu.

Within a sub-menu, touch the "←" symbol to return to the previous menu.

Exiting the basic settings

Touch the ← symbol to leave the "Basic settings" menu.

Saving or discarding changes

If changes have been made, when you exit the basic settings you will see a confirmation screen asking you if you wish to save or reject any changes made.

Home Connect

This appliance is WLAN-enabled and settings can be sent to the appliance via a mobile device.

If the appliance is not connected to the home network, the appliance functions in the same way as a hob with no network connection. The hob can always be operated via the control panel.

The availability of the Home Connect function depends on the availability of Home Connect services in your country. Home Connect services are not available in every country. You can find more information on this at www.home-connect.com.

Notes

- Hobs are not designed to be used unattended - you must always keep an eye on the cooking process.
- Ensure that you follow the safety instructions in this instruction manual and that these are also observed when operating the appliance via the Home Connect app. You must also follow the instructions in the Home Connect app. → *"Important safety information" on page 6*
- Using the Home Connect app, you can send settings to your appliance and then have to confirm them on the appliance. It is not possible to operate the appliance whilst you are away from home.
- Operation on the appliance always has priority. During this time, it is not possible to operate the appliance using the Home Connect app.

Setting up

To implement settings via Home Connect, you must have installed and set up the Home Connect app on your mobile device.

Observe the Home Connect documents supplied for this.

Follow the steps specified by the app to make the settings.

The app must be open in order to perform the setup process.

Automatic registration in the home network

You require a router that has WPS functionality.

You require access to your router. If you do not have this, follow the steps for "Manually logging into your home network".

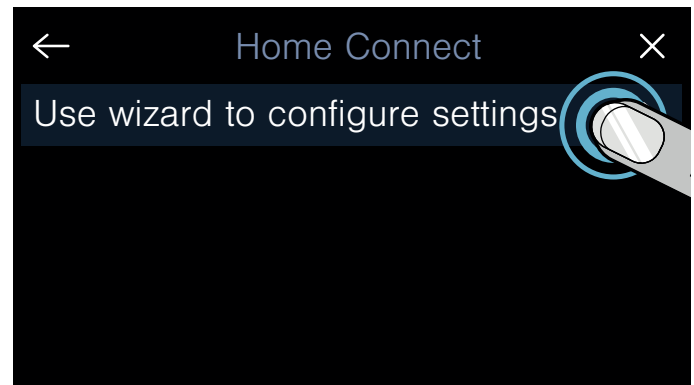

1. Touch the  symbol in the docking menu to open the basic settings.
2. Touch the "Home Connect" setting.
3. Touch "Use wizard to configure settings" to launch the Home Connect assistant.

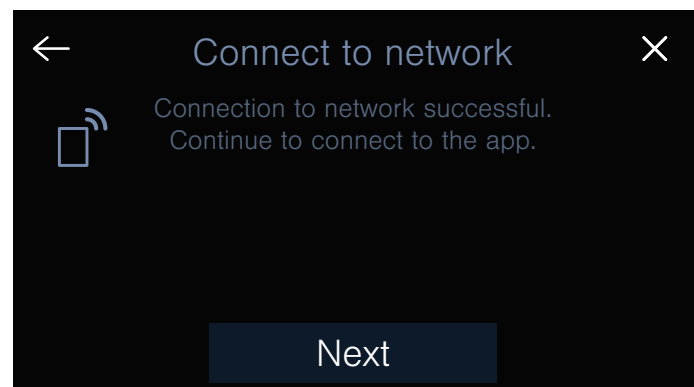

A message will appear regarding the mobile device.

4. Touch "Next" to continue.
 5. Press the WPS button on the router within the next 2 minutes.
A message will be displayed to notify you when the hob is successfully connected to your home network.
- Note:**
If it is unable to connect, relaunch the assistant or manually log the appliance into your home network. A message will appear to say that the appliance can now be connected to the app.
6. Touch "Next" to begin the process of connecting to the app.



A message is displayed to notify you that the connection has been successful. The  symbol will appear on the main screen. The brightness with which the  symbol lights up indicates the strength of the connection.

Manual registration in the home network

1. Touch the  symbol in the docking menu to open the basic settings.
2. Touch the "Home Connect" setting.
3. Touch "Use wizard to configure settings" to launch the Home Connect assistant.

You will be asked to press the WPS button on your router.

4. Select "WPS not supported".

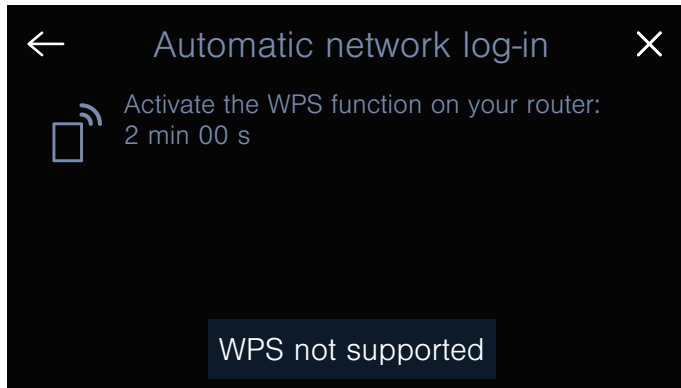

5. Read the message and touch Next to continue.
6. Open the network settings on your mobile device and use the SSID "Home Connect" and the key "Home Connect" to log your mobile device into the hob network.

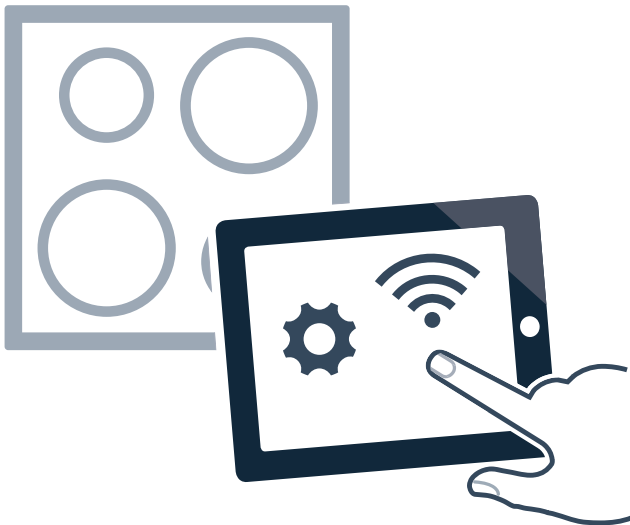



Note:

If it is unable to connect, relaunch the assistant and manually log the appliance into your home network.

7. Follow the prompt in the app and enter the name and password for your home network (Wi-Fi). A message will appear to say that the appliance can now be connected to the app.

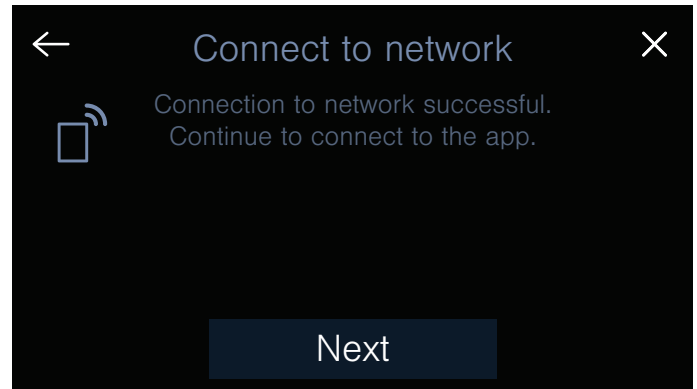
8. Touch "Next" to begin the process of connecting to the app.



A message is displayed to notify you that the connection has been successful. The  symbol will appear on the main screen. The brightness with which the  symbol lights up indicates the strength of the connection.

Home Connect settings

You can adjust Home Connect to suit your requirements at any time.

In the basic settings for your hob, navigate to the Home Connect settings to display network and appliance information.

Settings	Description and options
Use wizard to configure settings	<p>The hob can be logged into your home network automatically or manually.</p> <ul style="list-style-type: none"> ■ Use the assistant to configure the settings (automatic connection to the home network)*. ■ Use the assistant to configure the settings: WPS not supported (manually log into your home network). <p>Note: This setting is only displayed if the hob is not connected to your home network.</p>
Connect to app	<p>You can connect to one or more Home Connect accounts.</p> <p>Note: This setting is only displayed if the hob is connected to your home network.</p>
Setting via app	<p>You can choose whether to allow cooking settings to be sent.</p> <ul style="list-style-type: none"> ■ No: Only the hob's current status is displayed in the app. ■ Yes*: The cooking settings can be sent from the app to the hob. The cooking settings that are sent must be confirmed on the hob. <p>Note: This setting is only displayed if the hob is connected to your home network.</p>
Wi-Fi	<p>You can switch off the hob's wireless module to disconnect it from the Wi-Fi.</p> <ul style="list-style-type: none"> ■ Deactivated: Wireless module switched off. ■ Activated*: Wireless module connected. <p>Note: This setting is only displayed if the hob is connected to your home network.</p>
Disconnect from the network	<p>You can delete the saved connections to the home network at any time.</p> <p>Note: This setting is only displayed if the hob is connected to your home network.</p>
Appliance info.	<p>This displays information about Home Connect and the network.</p> <p>Note: This setting is only displayed if the hob is connected to your home network.</p>

*Factory setting

Note:

Use wizard to configure settings is only displayed if the appliance is not yet connected to your home network. All other settings are only displayed if the appliance is already connected to your home network.

Wi-Fi symbols

The Wi-Fi indicator on the main screen changes according to the status/quality of the connection and the availability of the Home Connect server.

Deactivating Wi-Fi

If Wi-Fi has been activated, you can use the Home Connect functions.

Note:

In networked standby mode, your appliance requires a maximum of 2 W.

1. Touch the  symbol in the docking menu to open the basic settings.
2. Touch the "Home Connect" setting.
3. Touch "Wi-Fi".

4. Select Off.

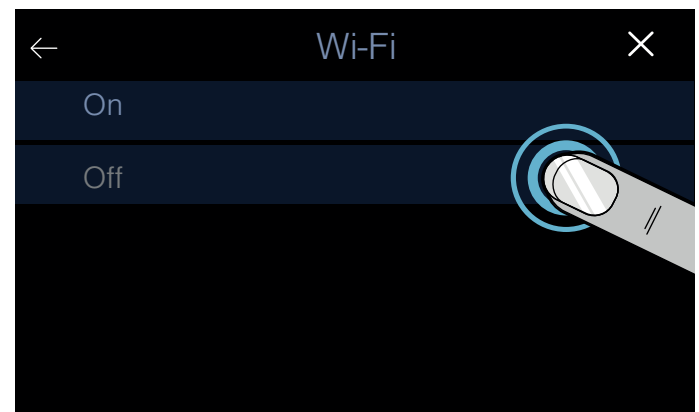

This deactivates Wi-Fi; the  symbol will go out on the control panel.

Disconnecting from the network

You can disconnect your hob from the network at any time.

Note:

If your hob is disconnected from the network, it is not possible to operate it using Home Connect.

1. Touch the  symbol in the docking menu to open the basic settings.
2. Touch the "Home Connect" setting.
3. Touch Disconnect from the network.
4. Touch "Next" to confirm.

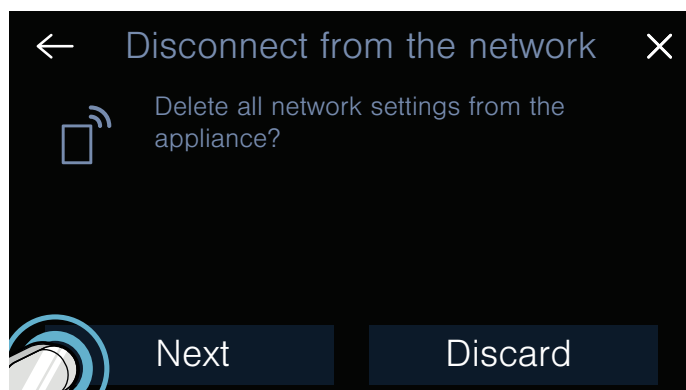

This disconnects the appliance from your home network; the  symbol will go out on the control panel.

Note:

The network connection will also be deleted if you restore the factory settings on your appliance.

Connecting to the network

1. Touch the  symbol in the docking menu to open the basic settings.
2. Touch the "Home Connect" setting.
3. Touch "Use wizard to configure settings" to launch the Home Connect assistant.
4. Follow the instructions as per → "Automatic registration in the home network" or → "Manual registration in the home network".

Connect to the app

If the Home Connect app is installed on your mobile device, you can connect it to your hob.

Notes

- The appliance must be connected to the network.
- The app must be open and be set up.
- If your extractor hood is directly connected, first disconnect the hob from your home network and then initiate the connection process again. → "Disconnecting from the network" on page 39 → "Connecting to the network" on page 39

1. Touch the  symbol in the docking menu to open the basic settings.
2. Touch the "Home Connect" setting.
3. Select Connect to app.

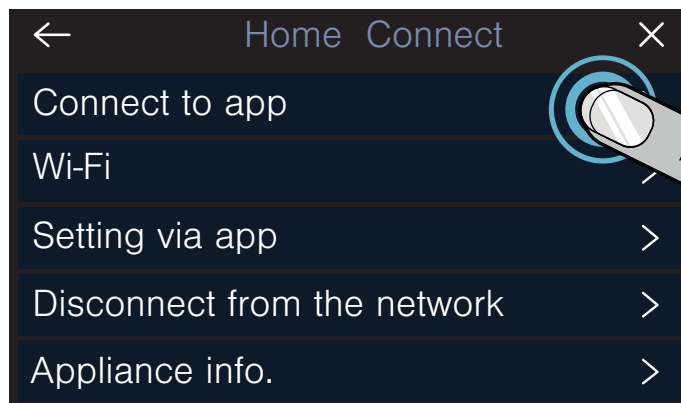

You can also connect a second Home Connect account to the hob. To do this, select Connect to app again.

4. Follow the instructions in the app to complete the connection process.

Settings via app

The Home Connect app provides easy access to the basic settings and enables you to send the settings for the cooking zones to the hob.

Notes

- The hob must be switched on, but all cooking zones must be switched off.
- Operating the appliance directly from the appliance always takes priority. If you operate the appliance directly, you can operate it via the Home Connect app.
- The appliance is delivered with settings transfer option activated.
- If the settings transfer option is deactivated, only the hob's operating status will be displayed in the Home Connect app.

1. Touch the  symbol in the docking menu to open the basic settings.
2. Touch the "Home Connect" setting.
3. Select Setting via app.

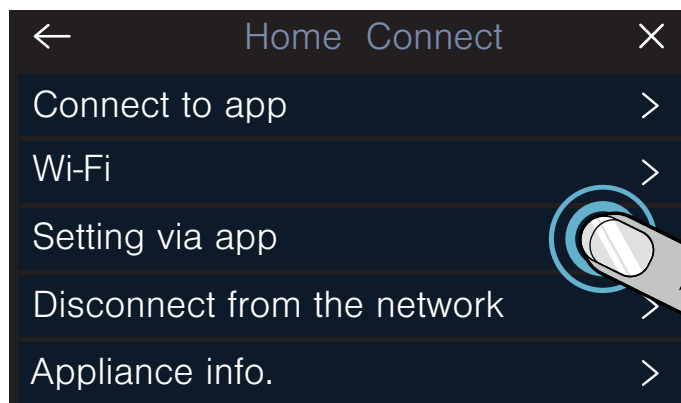

4. To activate the settings transmission option, touch On; to deactivate the settings transmission option, touch Off.

Confirming settings

Once cooking settings have been successfully transmitted to a cooking position, a message will appear on the hob. You will be asked whether you want to use these settings. To confirm that you want to use these settings, touch "Apply". To reject these settings, touch "Discard".

Software update

Using the software update function, the hob's software can be updated (e.g. for the purpose of optimisation, troubleshooting or security updates). To use the app, you must first register as a Home Connect user, install the app on your mobile device and connect to the Home Connect server.

The Home Connect app will tell you when a software update is available. You can start the software update via the app or the hob. To do this, refer to the instructions on the display.

Once the update has been successfully downloaded, you can install it via the Home Connect app if you are connected to your local area network.

The Home Connect app will notify you when the update has been successfully installed.

Notes

- You can continue to use the hob as normal while updates are downloading.
- Depending on your personal settings in the app, software updates can also be set to download automatically.
- We recommend that you install security updates as soon as possible.

Remote diagnostics

If a fault occurs, the after-sales service can use remote diagnostics to access your appliance.

Contact the after-sales service, making sure that your appliance is connected to the Home Connect server and checking that the remote diagnostics service is available in your country.

Note:

For more information and to check whether the remote diagnostics service is available in your country, please visit the Help & Support area of the Home Connect website for your country: www.home-connect.com

About data protection

When your appliance is connected for the first time to a WLAN network, which is connected to the Internet, your appliance transmits the following categories of data to the Home Connect server (initial registration):

- Unique appliance identification (consisting of appliance codes as well as the MAC address of the installed WiFi communication module).
- Security certificate of the WiFi communication module (to ensure a secure IT connection).
- The current software and hardware version of your domestic appliance.
- Status of any previous resetting to factory settings.

This initial registration prepares the Home Connect functions for use and is only required when you want to use these Home Connect functions for the first time.

Note:

Ensure that the Home Connect functions can be used only in conjunction with the Home Connect app. Information on data protection can be accessed in the Home Connect app.

Declaration of Conformity

BSH Hausgeräte GmbH hereby declares that the appliance which features Home Connect is in accordance with the basic requirements and the other relevant provisions of the directive 2014/53/EU.

A detailed RED Declaration of Conformity can be found online at www.siemens-home.bsh-group.com on the product page of your appliance with the additional documents.



2.4 GHz band: max. 100 mW

5 GHz band: max. 100 mW

	BE	BG	CZ	DK	DE	EE	IE	EL
	ES	FR	HR	IT	CY	LV	LT	LU
	HU	MT	NL	AT	PL	PT	RO	SI
	SK	FI	SE	UK	NO	CH	TR	

5 GHz Wi-Fi: for indoor use only

Hood control

You can connect this appliance to a suitable extractor hood and then control the functions of the hood via your hob.

You have various options for connecting the appliances together:

Home Connect

Two appliances can be connected using the Home Connect app provided that both of them are Home Connect-compatible.

Both appliances can be controlled via the app and via the control panel.

Refer to the Home Connect documents supplied and the Home Connect section for more information.

→ "Home Connect" on page 36



Connecting appliances directly

If the appliance is connected directly to an extractor hood, the extractor hood can be controlled via the hob. It is then not possible for either of the appliances to connect to your home network or to the app. Both appliances can be controlled via the control panel.

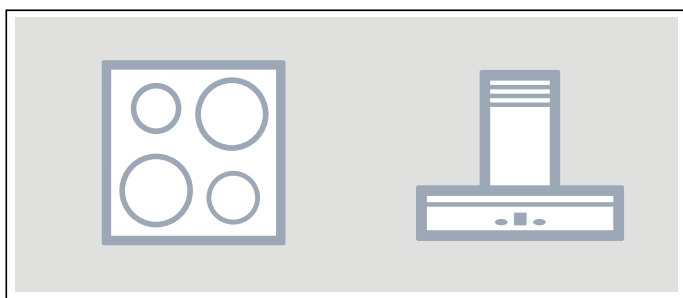

Connecting appliances via your home network

Use this type of connection if neither or one of the two appliances is connected to the Home Connect app.

If the appliances are connected to each other via your home network, you can use both the hood controls and Home Connect to operate the hob.

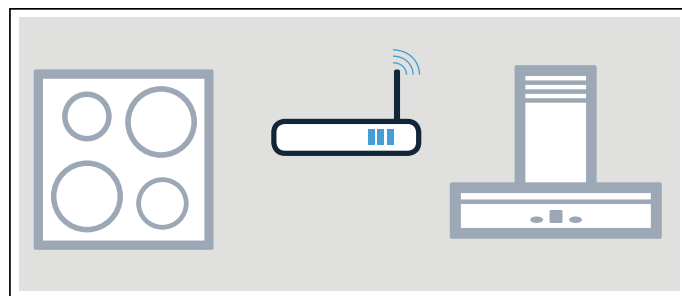

Notes

- Make sure you follow the safety instructions in the instruction manual for your extractor hood and that these are complied with even when operating the appliance via the hood controls on the hob. → "Important safety information" on page 6
- If the appliance is being operated by means of the controls on the extractor hood, this mode of operation always has priority. It is not possible to use the hood controls on the hob during this time.
- In networked standby mode, your appliance requires a maximum of 2 W.

Setting up

To set up the connection between the hob and the extractor hood, the hob must be switched on.

Connecting directly

Make sure that the extractor hood is switched off.

For more information refer to the section entitled "Connecting to the hob" in the instruction manual for your extractor hood.

Note:

If you connect your hob directly to the extractor hood, it cannot be connected to your home network as well and you will not be able to use Home Connect.

1. Touch the  symbol in the docking menu to open the basic settings.
2. Select the Hood control cookConnect hood control setting.
3. Touch "Connect directly".
4. You have 2 minutes to initiate the connection process on the extractor hood.

A message is displayed to notify you when the hob is successfully connected to the extractor hood. The symbols for the hood controls on the hob are displayed on the main screen.

Connecting via your home network

You require a router that has WPS functionality.

Access to your router is required. If you do not have this, follow the steps listed under "Direct connection".

When you begin, make sure that the extractor hood is connected to the same home network.

1. Touch the  symbol in the docking menu to open the basic settings.
2. Select the Hood control cookConnect hood control setting.
3. Touch "Connect to network".
4. Press the WPS button on the router within the next 2 minutes.
A message will be displayed to notify you when the hob is successfully connected to your home network.
5. You have 2 minutes to initiate the connection process on the extractor hood.

A message is displayed to notify you when the hob is successfully connected to the extractor hood. The symbols for the hood controls on the hob are displayed on the main screen.

Note:

Connection can only be established when both appliances are connected to your home network and the connection process has been initiated for both of them. If the time allowed for connecting has already expired for one of the two appliances, initiate the connection process again.

Disconnecting from the network

You can reset the connections you have saved for your home network and extractor hood at any time.

1. Touch the  symbol in the docking menu to open the basic settings.
2. Touch the "Hood control" setting.
3. Touch "Disconnect".
The connection has been restored.

Control the hood via the hob

In the basic settings of your hob you can adjust the behaviour of your extractor hood depending on the switch-on/off of the hob or individual cooking zones.
→ "Hood control settings" on page 43

You can select other settings using the control panel.

Setting the fan

Activation

1. Touch the  symbol in the settings area.
The preset fan setting is shown on the display.
2. Select the fan setting you require.
Touch **int 1** or **int 2** to select one of the intensive modes.

The fan has been activated.

Deactivating

1. Touch the  symbol in the settings area.
2. Select fan setting 0.
The fan has been deactivated.

Setting automatic mode

Activation

1. Touch the  symbol in the settings area.
2. Select **auto**.
Automatic mode is activated.
The fan starts automatically when steam is produced.

Deactivating

1. Touch the  symbol in the settings area.
2. Select fan setting 0.
Automatic mode is deactivated.

Setting the hood lighting

The hood light can be switched on and off using the control panel on the hob.

Touch the  symbol on the main screen.

Hood control settings

You can adapt the hood controls on the hob to suit your needs at any time.

Note:

The settings will only be displayed if the appliance is connected to an extractor hood.

Ajustes	Descripción y opciones
Fan control	<p>If you wish, you can set the fan to start up after the hob is switched on, and you can configure the settings depending on how you want the fan to run.</p> <ul style="list-style-type: none"> ■ Switched off: You will need to switch the hood on manually when needed. ■ Switched on in automatic mode*: The hood switches on when setting an independent hob in automatic mode. ■ Switch on in standard fan run-on*: The hood switches on when setting an independent hob to a fixed setting.
Fan run-on	<p>The fan continues running to ensure that residual odours are eliminated. The fan will switch off automatically afterwards.</p> <ul style="list-style-type: none"> ■ Off ■ Switch on in automatic mode.* ■ Switch on in standard fan run-on. ■ No change: The fan settings will not change if you switch off the hob.
Automatic light on	<p>If you wish, you can set the hood light to automatically come on when the hob is switched on.</p> <ul style="list-style-type: none"> ■ On* – The light switches on when you switch on the hob. ■ Off
Automatic light off	<p>You can specify whether you want the hood lighting to be switched off automatically when you switch off the hob.</p> <ul style="list-style-type: none"> ■ Deactivated* ■ Activated: The lighting switches off when the hob is switched off.
Disconnect	<p>You can delete the connections to your home network and extractor hood that you have saved at any time.</p>
*Factory settings	

Maximum power consumption

You can use the Maximum power consumption function to set the total power of the hob.

The hob settings are preconfigured at the factory. Its maximum performance is specified on the rating plate. You can use the power manager function to change the value to meet the requirements of the specific electrical installation.

To ensure that this set value is not exceeded, the hob has a series of components that intelligently and automatically share the available power between the cooking zones that are switched on.

While the Maximum power consumption function is activated, the output of a cooking zone may temporarily fall below the nominal value. If a cooking zone is switched on and maximum power has been reached, a corresponding message appears in the display. The appliance controls and selects the highest power level automatically.

For more information about how the total power of the hob is changed, see the section entitled → "Basic settings"

Cleaning

Suitable maintenance and cleaning products can be purchased from the after-sales service or in our e-Shop.

Hob

Cleaning

Always clean the hob after cooking. This will prevent food deposits from becoming burned on. Only clean the hob after the residual heat indicator has gone out.

Clean the hob with a damp dish cloth and dry it with a cloth or towel to prevent limescale build-up.

Only use cleaning agents that are suitable for this type of hob. Observe the manufacturer's instructions on the product packaging.

Never use:

- Undiluted washing-up liquid
- Cleaning agents designed for dishwashers
- Abrasive cleaners
- Harsh cleaning agents, such as oven spray and limescale remover
- Scouring pads
- High-pressure cleaners or steam jet cleaners

Stubborn dirt is best removed with a glass scraper, available from retailers. Observe the manufacturer's instructions.

You can obtain a suitable glass scraper from customer services or through our online shop.

Using a special sponge for cleaning glass-ceramic hobs achieves a great cleaning result.

Potential marks

Limescale and water marks	Clean the hob as soon as it has cooled down. You can use a cleaning agent suitable for glass-ceramic hobs.*
Sugar, rice starch or plastic	Clean immediately. Use a glass scraper. Caution: Risk of burns.*

* Then clean with a damp dish cloth and dry with a cloth or towel.

Note: Do not use any cleaning agents while the hob is still hot. This may mark the surface. Make sure that any residue left by cleaning agents is removed.

Hob surround

To prevent damage to the hob surround, observe the following instructions:

- Only use warm soapy water
- Wash new dish cloths thoroughly before use.
- Do not use harsh or abrasive cleaning agents.
- Do not use a glass scraper or sharp objects.

Frequently Asked Questions (FAQ)

Use

Nothing appears in the display.

The brightness may not be set correctly. Look at the display from above and set the brightness in the basic settings. For more information about the settings, see the section entitled → *"Basic settings"*.

The main display shows a warning message and a signal tone sounds.

Remove any liquid or remnants of food from the control panel. Remove any objects from the control panel. For instructions on how to deactivate the signal tone, see the section entitled → *"Basic settings"*.

Noises

Why can I hear noises while I'm cooking?

Noises may be generated while using the hob depending on the base material of the cookware. These noises are normal for induction technology. They do not indicate that there is a fault.

Possible noises:

A low humming noise of the kind a transformer makes:

Occurs when cooking at a high power level. The noise disappears or becomes quieter when the power level is reduced.

Quiet humming:

The cookware may be too small for the cooking position or not suitable for induction cooking. Use a bigger item of cookware or move it to a different position on the cooking surface.

Quiet whistling:

This happens when the cookware is empty. The noise disappears when water or food is added to the cookware.

High-pitched whistling noises:

These may occur if two cooking positions are used at the highest power level at the same time. The whistling noises disappear or become quieter when the power level is reduced.

Crackling:

This occurs when using cookware made from layers of different material or when using cookware of different sizes and different materials at the same time. How loud the noise is may vary depending on the quantity of food you are cooking and the method you are using.

Fan noise:

The hob is equipped with a fan that automatically switches on at high temperatures. The fan may continue to run even after you have switched off the hob if the temperature detected is still too high.

Clicking:

Occasional clicking when activating or moving an item of cookware is completely normal.

Now and again, other completely random noises that have nothing to do with the cookware may occur.

Cookware

Which types of cookware can be used with an induction hob?

For information on which types of cookware can be used with an induction hob, see the section entitled → *"Induction cooking"*.

Why is the hob not heating up?

Make sure that the cookware is suitable for use with an induction hob. For information on the type, size and positioning of the cookware, see the section entitled → *"Induction cooking"*.

Why is it taking so long for the cookware to heat up or why is it not heating up correctly despite being on a high power level?

Make sure that the cookware is suitable for use with an induction hob. For information on the type, size and positioning of the cookware, see the section entitled → *"Induction cooking"*.

The depiction of the cookware on the touchscreen display does not match the actual cookware in terms of size and shape.

The depiction of the cookware on the touchscreen display is purely indicative.
Make sure that the item of cookware is inside the usable area of the cooking surface.

There is cookware on the cooking surface that is not being shown on the touchscreen display.

There are more than eight items of cookware on the cooking surface.
The cookware is too small: A diameter of between 90 and 340 mm is recommended.
Use a bigger item of cookware or cookware that is suitable for induction cooking. Alternatively, move the cookware to a different position on the cooking surface. For information on which types of cookware can be used with an induction hob, see the section entitled → *"Induction cooking"*.

There are two items of cookware on the cooking surface. However, the touchscreen display displays this as just one item of cookware.

If two pots or pans are placed very close together on the cooking surface, the touchscreen display may depict them as one item of cookware.
Move the two items away from each other until the touchscreen display depicts them separately.

There is an item of cookware on the cooking surface. However, the touchscreen display depicts two or more.

The base of the cookware may be deformed or embossed, or the cookware is not suitable for induction cooking.
Check how flat the base of the cookware is and place it back on the cooking surface. For information on the type, size and positioning of the cookware, see the section entitled → *"Induction cooking"*.

Not every item of cookware that is on the cooking surface can be activated.

You can place up to eight items of cookware on the cooking surface but only up to six evenly distributed items can be used at the same time.
For information on how to position the cookware, see the section entitled → *"Induction cooking"*
You can cook with up to three items of cookware on each side. If there is an item of cookware in the centre of the cooking surface or an item of cookware is too large, the number of "active" pots or pans is restricted.
For information on how to position the cookware, see the section entitled → *"Induction cooking"*
One of the items of cookware is not suitable for induction cooking. The  symbol appears on the touchscreen display next to the unsuitable pot or pan.
For information on which items of cookware are suitable for induction cooking, see the section entitled → *"Induction cooking"*
The appliance has exceeded its maximum power consumption or the Maximum power consumption setting has been activated.
Check the installation and configure the Maximum power consumption setting correctly. See the section entitled → *"Basic settings"*

The power level cannot be increased.

The appliance has reached its maximum power consumption or the Maximum power consumption setting has been activated.
Change how the items of cookware are arranged on the cooking surface. Check the installation and configure the Maximum power consumption setting correctly. See the section entitled → *"Basic settings"*

The cooking sensor is not available.

The appliance has reached its maximum power consumption or the Maximum power consumption setting has been activated.
To make the cooking sensor ready to use, reduce or switch off the power levels for the other pans. Change how the items of cookware are arranged on the cooking surface. Check the installation and configure the Maximum power consumption setting correctly. See the section entitled → *"Maximum power consumption"*

If you use the appliance intensively, this may increase the required cooking times.

This may be due to the fact that internal safety mechanisms are preventing the cooker from overheating.
Try moving the cookware to a different position.

Bubbles are forming with an uneven distribution within the cookware.

Depending on the power level that is selected, the type of cookware or the combination with other cookware, bubbles may form unevenly.
This does not affect the temperature or the cooking process.

For information on the type, size and positioning of the cookware, see the section entitled → *"Induction cooking"*

Cleaning**How do I clean the hob?**

You can achieve the best results by using special glass-ceramic cleaning products. Do not use any harsh or abrasive cleaning products, dishwasher detergent (concentrated) or scouring pads.

For more information on cleaning and caring for your hob, see the section entitled → *"Cleaning"*.

Home network**Why will the hob not connect to the home network after the WPS button has been pressed on the router?**

Once the "Connect automatically" option has been selected, press the WPS button on the router within the next two minutes.

If this time has already elapsed, repeat the connection procedure. If the problems persist, restore the appliance to factory settings; see section → *"Basic settings"*.

Why is my mobile device not logging into the Home Connect network?

Use the SSID "HomeConnect" and password "HomeConnect" to connect.

Make sure that you have entered all the characters correctly and that you have used upper and lower case in the relevant places.

Trouble shooting

Faults often have simple explanations. Please read the information and tips provided below before calling the after-sales service.

Information, warnings and fault codes

In the event of a problem, information, warnings or fault codes will automatically appear on the display. Follow the instructions on the touchscreen display to rectify the problem.

Notes

- A fault code will also be displayed with some warnings. If necessary, provide the after-sales service with the fault code.
- If a fault occurs, the appliance will not switch to standby mode.

Tips

Problem	Solution
The hob will not switch on.	Use other electrical appliances to check whether a short circuit has occurred in the power supply. Make sure that you have connected the appliance as shown in the circuit diagram. If you are unable to rectify the fault, contact our technical after-sales service.
The touchscreen display is not responding or has frozen.	The control panel is damp or there is something on it. Dry the control panel or remove the object.
The cooking zone's power level cannot be increased.	The hob's total power output has been limited. Change the total power under Maximum power consumption in the basic settings. If a very large item of cookware is being used, this may have an effect on the maximum power level for that half of the hob. Set the cookware down again.
An audible signal will sound if there is something on the touchscreen display.	Remove the object and reconfigure the hob settings. Do not place hot cookware on the control panel.
The hob is responding in an unusual manner or cannot be operated properly.	Switch the appliance off using the main fuse or the circuit breaker in the fuse box. Wait a few seconds before reconnecting the appliance.
The electronics have overheated and have switched off the affected cooking zone.	Wait until the electronics have cooled down sufficiently. When the fault indicator goes out, you can continue cooking.
The electronics have overheated and all the cooking zones have been switched off.	
There is hot cookware near the control panel. The cooking zone has been switched off to protect the electronics.	Remove the cookware that is causing the problem. Wait a few seconds. When the fault indicator goes out, you can continue cooking.
The cooking zone has overheated and has been switched off to protect the work surface.	Wait until the electronics have cooled down sufficiently. Then switch the cooking zone on again.
The transfer settings function cannot be activated.	You have removed the active item of cookware from its position and set a pot or pan of a different size down instead. Test with the same item of cookware.
The hob has been operating continuously for an extended period.	The automatic safety cut-out function has been activated. See the section entitled → "Automatic safety cut-out"
The activeLight light strips at the sides are not lighting up.	Contact our technical after-sales service.
The cooking sensor has overheated and the cooking zone has been switched off. E8202	Wait until the temperature sensor has cooled down sufficiently. Then reactivate the function.
The cooking sensor has overheated and the adjacent cooking zones have been switched off. E8203	If you are not using the cooking sensor, remove it from the cookware and keep it away from other cooking zones or heat sources. Switch the cooking zones on again.
The battery in the cooking sensor is almost flat. E8204	Replace the 3 V CR2032 battery. See the section entitled → "Changing the battery"
The connection to the cooking sensor has been broken. E8205	Switch the function off and then on again.
The cooking sensor is broken/faulty. E8206	Contact our technical after-sales service.

Problem	Solution
The cooking sensor indicator will not light up and the cooking sensor is not responding.	Replace the 3 V CR2032 battery. See the section entitled → <i>"Changing the battery"</i> If this does not solve the problem, press and hold the symbol on the cooking sensor for 8-10 seconds and then reconnect the cooking sensor to the hob. See the section entitled → <i>"Connecting the wireless temperature sensor to the control panel"</i> If the problem persists, contact our technical after-sales service.
The indicator on the sensor flashes twice. The battery in the cooking sensor is almost flat. You may be interrupted the next time you cook by the battery running out.	Replace the 3 V CR2032 battery. See the section entitled → <i>"Changing the battery"</i>
The indicator on the sensor flashes three times. The connection to the cooking sensor has been broken.	Press and hold the symbol on the cooking sensor for 8-10 seconds and then reconnect the cooking sensor to the hob. See the section entitled → <i>"Connecting the wireless temperature sensor to the control panel"</i>
The hob is unable to connect to your home network or the extractor hood. E7010	Switch the hob off and then on again. If the message appears again, contact our technical after-sales service.
The operating voltage is incorrect and outside of the normal operating range. E9000/E9010	Contact your electricity supplier.
The hob is not connected correctly U400	Disconnect the hob from the mains. Make sure that you have connected the hob as shown in the circuit diagram.

Demo mode

If the ^{DEMO}MODE symbol is shown on the display, demo mode is active. The appliance does not heat up in demo mode. Disconnect the appliance from the power supply. Wait a few seconds before reconnecting the appliance. Then deactivate demo mode in the basic settings within 3 minutes of switching on the appliance.

Customer service

Our after-sales service is there for you if your appliance needs to be repaired. We will always find an appropriate solution, also in order to avoid after-sales personnel having to make unnecessary visits.

E number and FD number

Please quote the E number (product number) and the FD number (production number) of your appliance when contacting the after-sales service.

The rating plate bearing these numbers can be found:

- On the appliance certificate.
- On the lower section of the hob.

The E-number can also be found on the glass surface of the hob. You can check the customer index (KI) and FD number by going to the basic settings. Look up section → "*Basic settings*" for this.

Please note that a visit from an after-sales service engineer is not free of charge in the event of misuse of the appliance, even during the warranty period.

Please find the contact data of all countries in the enclosed customer service list.

To book an engineer visit and product advice

GB 0344 892 8999

Calls charged at local or mobile rate.

IE 01450 2655

0.03 € per minute at peak. Off peak 0.0088 € per minute.

Rely on the professionalism of the manufacturer. You can therefore be sure that the repair is carried out by trained service technicians who carry original spare parts for your appliances.

BSH Hausgeräte GmbH

Carl-Wery-Str. 34
81739 München

GERMANY

Valid within Great Britain:

Imported to Great Britain by

BSH Home Appliances Ltd.
Grand Union House
Old Wolverton Road
Wolverton, Milton Keynes
MK12 5PT
United Kingdom

Manufactured by BSH Hausgeräte GmbH under Trademark License of Siemens AG

siemens-home.bsh-group.com



9001384527 (991129)