

SIEMENS

Microwave

CP465AGB0., CP565AGS0.

en Instruction manual





Register your product on My Siemens and discover exclusive services and offers.

siemens-home.bsh-group.com/welcome

The future moving in.

Siemens Home Appliances

Table of contents

 Intended use	4	 Automatic programmes	23
 Important safety information	4	Setting a programme	23
General information	4	Programme table	24
Microwave	5	 Setting the time-setting options	26
Steam	6	Checking the time settings	26
 Causes of damage	7	Setting the timer	26
General information	7	Setting a cooking time	26
Microwave	7	Initial use	27
Steam	8	 Childproof lock	27
 Environmental protection	8	Activating and deactivating	27
Saving energy	8	 Basic settings	28
Environmentally-friendly disposal	8	Changing the basic settings	28
 Getting to know your appliance	9	List of basic settings	28
Control panel	9	 Cleaning	29
Function selector	9	Suitable cleaning agents	29
Touch fields and display	9	Cleaning self-cleaning surfaces	30
Rotary selector	11	Keeping the appliance clean	30
Operating modes	11	 Cleaning function	30
Types of heating	11	Descaling	30
Steam	11	Rinsing	31
Microwave	11	Subsequent cleaning	31
Cooking compartment	12	Emptying the waste water tank	31
Tank cover	12	 Trouble shooting	32
Water tank	12	 Customer service	34
Waste water tank	12	E number and FD number	34
 Accessories	13	 Tested for you in our cooking studio	34
Accessories included	13	General information	34
Additional accessories	13	Defrosting	35
Special accessories	13	Heating frozen food	37
Inserting accessories	13	Warming	37
 Before using for the first time	14	Cakes, small baked items and bread	38
Initial use	14	Bakes and gratins	41
Set the water hardness range	14	Poultry, meat and fish	41
Cleaning the cooking compartment and accessories ..	14	Vegetables and side dishes	44
 Operating the appliance	15	Desserts	45
Switching the appliance on and off	15	Acrylamide in foodstuffs	46
Selecting an operating mode	15	Test dishes	46
Setting the heating function and temperature	15		
Rapid heating	16		
Automatic safety switch-off function	16		
 Microwave	16		
Cookware	16		
Microwave power settings	17		
Setting the microwave	17		
Setting the microwave to combined operation	18		
 Steam	19		
Noise	19		
Cooking with steam	19		
Setting the steam combination	20		
Filling the water tank	20		
Refilling the water tank	21		
After every steam operation	21		

Additional information on products, accessories, replacement parts and services can be found at **www.siemens-home.bsh-group.com** and in the online shop **www.siemens-home.bsh-group.com/eshops**

Intended use

Read these instructions carefully. Only then will you be able to operate your appliance safely and correctly. Retain the instruction manual and installation instructions for future use or for subsequent owners.

This appliance is only intended to be fully fitted in a kitchen. Observe the special installation instructions.

Check the appliance for damage after unpacking it. Do not connect the appliance if it has been damaged in transport.

Only a licensed professional may connect appliances without plugs. Damage caused by incorrect connection is not covered under warranty.

This appliance is intended for domestic use only. The appliance must only be used for the preparation of food and drink. The appliance must be supervised during operation. Only use this appliance indoors.

This appliance is intended for use up to a maximum height of 4000 metres above sea level.

This appliance may be used by children over the age of 8 years old and by persons with reduced physical, sensory or mental capabilities or by persons with a lack of experience or knowledge if they are supervised or are instructed by a person responsible for their safety how to use the appliance safely and have understood the associated hazards.

Children must not play with, on, or around the appliance. Children must not clean the appliance or carry out general maintenance unless they are at least 15 years old and are being supervised.

Keep children below the age of 8 years old at a safe distance from the appliance and power cable.

Important safety information

General information

Warning – Risk of fire!

- The appliance becomes very hot. If the appliance is installed in a fitted unit with a decorative door, heat will accumulate when the decorative door is closed. Only operate the appliance when the decorative door is open.
- Combustible items stored in the cooking compartment may catch fire. Never store combustible items in the cooking compartment. Never open the appliance door if there is smoke inside. Switch off the appliance and unplug it from the mains or switch off the circuit breaker in the fuse box.
- Loose food remnants, fat and meat juices may catch fire. Before using the appliance, remove the worst of the food remnants from the cooking compartment, heating elements and accessories.
- A draught is created when the appliance door is opened. Greaseproof paper may come into contact with the heating element and catch fire. Do not place greaseproof paper loosely over accessories during preheating. Always weight down the greaseproof paper with a dish or a baking tin. Only cover the surface required with greaseproof paper. Greaseproof paper must not protrude over the accessories.

Warning – Risk of burns!

- The appliance becomes very hot. Never touch the interior surfaces of the cooking compartment or the heating elements. Always allow the appliance to cool down. Keep children at a safe distance.
- Accessories and ovenware become very hot. Always use oven gloves to remove accessories or ovenware from the cooking compartment.
- Alcoholic vapours may catch fire in the hot cooking compartment. Never prepare food containing large quantities of drinks with a high alcohol content. Only use small quantities of drinks with a high alcohol content. Open the appliance door with care.

⚠ Warning – Risk of scalding!

- The accessible parts become hot during operation. Never touch the hot parts. Keep children at a safe distance.
- When you open the appliance door, hot steam can escape. Steam may not be visible, depending on its temperature. When opening, do not stand too close to the appliance. Open the appliance door carefully. Keep children away.
- Water in a hot cooking compartment may create hot steam. Never pour water into the cooking compartment when the cooking compartment is hot.

⚠ Warning – Risk of injury!

Scratched glass in the appliance door may develop into a crack. Do not use a glass scraper, sharp or abrasive cleaning aids or detergents.

⚠ Warning – Risk of electric shock!

- Incorrect repairs are dangerous. Repairs may only be carried out and damaged power cables replaced by one of our trained after-sales technicians. If the appliance is defective, unplug the appliance from the mains or switch off the circuit breaker in the fuse box. Contact the after-sales service.
- The cable insulation on electrical appliances may melt when touching hot parts of the appliance. Never bring electrical appliance cables into contact with hot parts of the appliance.
- Do not use any high-pressure cleaners or steam cleaners, which can result in an electric shock.
- Penetrating moisture may cause electric shock. Never subject the appliance to intense heat or humidity. Only use this appliance indoors.
- A defective appliance may cause electric shock. Never switch on a defective appliance. Unplug the appliance from the mains or switch off the circuit breaker in the fuse box. Contact the after-sales service.

⚠ Warning – Hazard due to magnetism!

Permanent magnets are used in the control panel or in the control elements. They may affect electronic implants, e.g. heart pacemakers or insulin pumps. Wearers of electronic implants must stay at least 10 cm away from the control panel.

Microwave**⚠ Warning – Risk of burns!**

- Using the appliance for anything other than its intended purpose is dangerous. You are not permitted to use it to dry food or clothing or to warm slippers, grain or cereal pillows, sponges, damp cleaning cloths or the like. This is because, for instance, overheated slippers, grain or cereal pillows, sponges and damp cleaning cloths, etc., may cause burns to the skin.
- Food may catch fire. Never heat food in heat-retaining packages. Do not leave food heating unattended in containers made of plastic, paper or other combustible materials. Do not select a microwave power or time setting that is higher than necessary. Follow the information provided in this instruction manual. Never use the microwave to dry food. Never defrost or heat food with a low water content, e.g. bread, at too high a microwave power or for too long.
- Cooking oil may catch fire. Never use the microwave to heat cooking oil on its own.

⚠ Warning – Risk of explosion!

Liquids and other food may explode when in containers that have been tightly sealed. Never heat liquids or other food in containers that have been tightly sealed.

⚠ Warning – Risk of burns!

- Foods with peel or skin may burst or explode during, or even after, heating. Never cook eggs in their shells or reheat hard-boiled eggs. Never cook shellfish or crustaceans. Always prick the yolk when baking or poaching eggs. The skin of foods that have a peel or skin, such as apples, tomatoes, potatoes and sausages, may burst. Before heating, prick the peel or skin.
- Heat is not distributed evenly through baby food. Never heat baby food in closed containers. Always remove the lid or teat. Stir or shake well after the food has been heated. Check the temperature of the food before it is given to the child.
- Heated food gives off heat. The ovenware may become hot. Always use oven gloves to remove ovenware or accessories from the cooking compartment.

- Airtight packaging may burst when food is heated. Always observe the instructions on the packaging. Always use oven gloves to remove dishes from the cooking compartment.
- The accessible parts become very hot when in operation. Never touch hot parts. Keep children at a safe distance.
- Using the appliance for anything other than its intended purpose is dangerous. You are not permitted to use it to dry food or clothing or to warm slippers, grain or cereal pillows, sponges, damp cleaning cloths or the like. This is because, for instance, overheated slippers, grain or cereal pillows, sponges and damp cleaning cloths, etc., may cause burns to the skin.

⚠ Warning – Risk of scalding!

- There is a possibility of delayed boiling when a liquid is heated. This means that the liquid reaches boiling temperature without the usual steam bubbles rising to the surface. Even if the container only vibrates a little, the hot liquid may suddenly boil over and spatter. When heating, always place a spoon in the container. This will prevent delayed boiling.

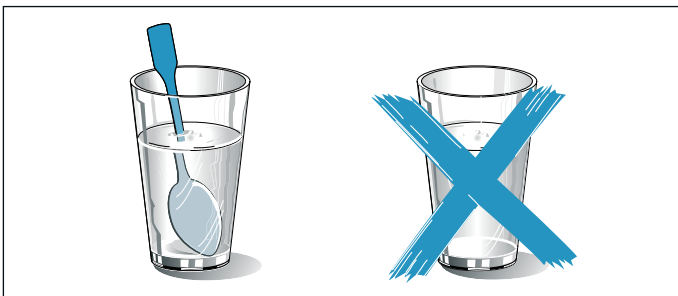

⚠ Warning – Risk of injury!

- Unsuitable ovenware may crack. Porcelain or ceramic ovenware can have small perforations in the handles or lids. These perforations conceal a cavity below. Any moisture that penetrates this cavity could cause the ovenware to crack. Only use microwave-safe ovenware.
- If using the appliance in microwave mode only, placing cookware and containers made of metal or featuring metal detailing inside the appliance may cause sparks when the appliance is operating. This may damage the appliance. Never use metal containers when using the appliance in microwave mode only.

⚠ Warning – Risk of electric shock!

The appliance is a high-voltage appliance. Never remove the casing.

⚠ Warning – Risk of serious damage to health!

- The surface of the appliance may become damaged if it is not cleaned properly. Microwave energy may escape. Clean the appliance on a regular basis, and remove any food residue immediately. Always keep the cooking compartment, door seal, door and door stop clean. → "Cleaning" on page 29
- Microwave energy may escape if the cooking compartment door or the door seal is damaged. Never use the appliance if the cooking compartment door, the door seal or the plastic door frame is damaged. Call the after-sales service.
- Microwave energy will escape from appliances that do not have any casing. Never remove the casing. For any maintenance or repair work, contact the after-sales service.

Steam

⚠ Warning – Risk of scalding!

- The water in the water tank may become very hot if you continue to operate the appliance. Empty the water tank after every operation with steam.
- Hot steam is generated in the cooking compartment. Do not reach into the cooking compartment during any operation with steam.
- Hot liquid may spill over the sides of the accessory when it is removed from the cooking compartment. Remove hot accessories with care and always wear oven gloves.

⚠ Warning – Risk of injury and risk of fire!

Flammable liquids can catch fire in the cooking compartment when it is hot (explosion). Do not fill the water tank with any flammable fluids (e.g. alcoholic drinks). Only fill the water tank with water or with the descaling solution that is recommended by us.

Causes of damage

General information

Caution!

- **Water in the hot cooking compartment:** Never pour water into the hot cooking compartment. This will cause steam. The temperature change can cause damage.
- **Moisture in the cooking compartment:** Over an extended period of time, moisture in the cooking compartment may lead to corrosion. Allow the cooking compartment to dry after use. Do not keep moist food in the closed cooking compartment for extended periods of time. Do not store food in the cooking compartment.
- **Cooling with the appliance door open:** Following operation at high temperatures, only allow the cooking compartment to cool down with the door closed. Do not trap anything in the appliance door. Even if the door is only left open a crack, the front of nearby furniture may become damaged over time. Only leave the cooking compartment to dry with the door open if a lot of moisture was produced whilst the oven was operating.
- **Extremely dirty seal:** If the seal is very dirty, the appliance door will no longer close properly during operation. The fronts of adjacent units could be damaged. Always keep the seal clean. Never operate the appliance if the seal is damaged or missing. → "Cleaning" on page 29
- **Appliance door as a seat, shelf or worktop:** Do not sit on the appliance door, or place or hang anything on it. Do not place any cookware or accessories on the appliance door.
- **Inserting accessories:** depending on the appliance model, accessories can scratch the door panel when closing the appliance door. Always insert the accessories into the cooking compartment as far as they will go.
- **Carrying the appliance:** do not carry or hold the appliance by the door handle. The door handle cannot support the weight of the appliance and could break.

Microwave

Caution!

- **Aluminium foil:** Aluminium foil in the cooking compartment must not come into contact with the door glass. This could cause permanent discolouration of the door glass.
- **Creation of sparks:** Metal – e.g. a spoon in a glass – must be kept at least 2 cm from the cooking compartment walls and the inside of the door. Sparks can irreparably damage the glass on the inside of the door.
- **Microwave and microwave combination mode:** The wire rack is not suitable for use in microwave mode or microwave mode combined with a type of heating. If you use either of these, this may create sparks, which may damage the cooking compartment.
- **Foil containers:** Do not use foil containers in the appliance. They damage the appliance by producing sparks.
- **Operating the microwave without food:** Operating the appliance without food in the cooking compartment may lead to overloading. Never switch on the microwave unless there is food inside. The short crockery test is the exception to this rule. → "Microwave" on page 16

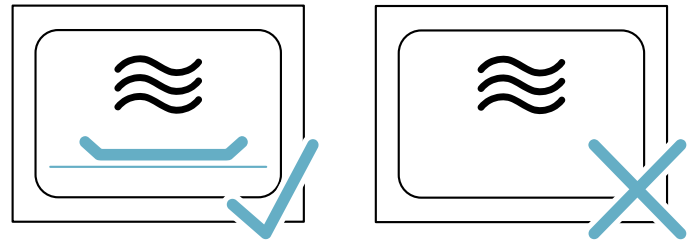

- **Microwave popcorn:** Never set the microwave power too high. The door panel may crack if overloaded. Use a power setting no higher than 600 watts. Always place the popcorn bag on a glass plate.

Steam

Caution!

- Appliance care: Your appliance's cooking compartment is made from high-quality stainless steel. Improper care may lead to corrosion in the cooking compartment. Follow the care and cleaning instructions in the instruction manual. Remove food remnants from the cooking compartment surfaces as soon as the appliance has cooled down.
- Baking tins: Ovenware must be heat and steam resistant. Silicone baking tins are not suitable for combined operation with steam.
- Ovenware with areas of rust: Do not use any ovenware which displays areas of rust. Even the smallest spots of rust can lead to corrosion in the cooking compartment.
- Dripping liquids: During steaming, insert the glass tray into shelf position 3 and place the steam container onto the glass tray. Any dripping liquid is caught in the glass tray.
- Hot water in the water tank: Hot water can damage the pump. Do not pour hot water into the water tank.
- Risk of damage to the cooking compartment: Do not use the appliance if there is water on the cooking compartment floor. Before using the appliance, wipe away the water from the cooking compartment floor.
- Descaling solution: Do not allow any descaling solution to come into contact with the control panel or other surfaces on the appliance. This damages the surfaces. If this does happen, remove the descaling solution immediately with water.
- Cleaning the water tank: Do not clean the water tank in the dishwasher. Otherwise, the water tank will be damaged. Clean the water tank with a soft cloth and standard washing-up liquid.
- Frost protection: To prevent frost damage during transportation and storage, the appliance must be completely emptied beforehand.

Environmental protection

Your new appliance is particularly energy-efficient. Here you can find tips on how to save even more energy when using the appliance, and how to dispose of your appliance properly.

Saving energy

- Only preheat the appliance if this is specified in the recipe or in the tables in the operating instructions.
- Use dark, black lacquered or enamelled baking tins for baking. These absorb the heat particularly well.
- Remove all unnecessary accessory and tableware out of the cooking compartment.
- Do not open the appliance door during operation.
- It is best to bake several cakes one after the other. The cooking compartment is still warm. This reduces the baking time for the second cake. You can place two cake tins next to each other in the cooking compartment.
- For longer cooking times, you can switch the appliance off 10 minutes before the end of the cooking time and use the residual heat to finish cooking.

Environmentally-friendly disposal

Dispose of packaging in an environmentally-friendly manner.



This appliance is labelled in accordance with European Directive 2012/19/EU concerning used electrical and electronic appliances (waste electrical and electronic equipment - WEEE). The guideline determines the framework for the return and recycling of used appliances as applicable throughout the EU.

Getting to know your appliance

In this section, we explain the display and controls. You will also find out about the various functions of your appliance.

Note: Depending on the appliance model, individual details and colours may differ.

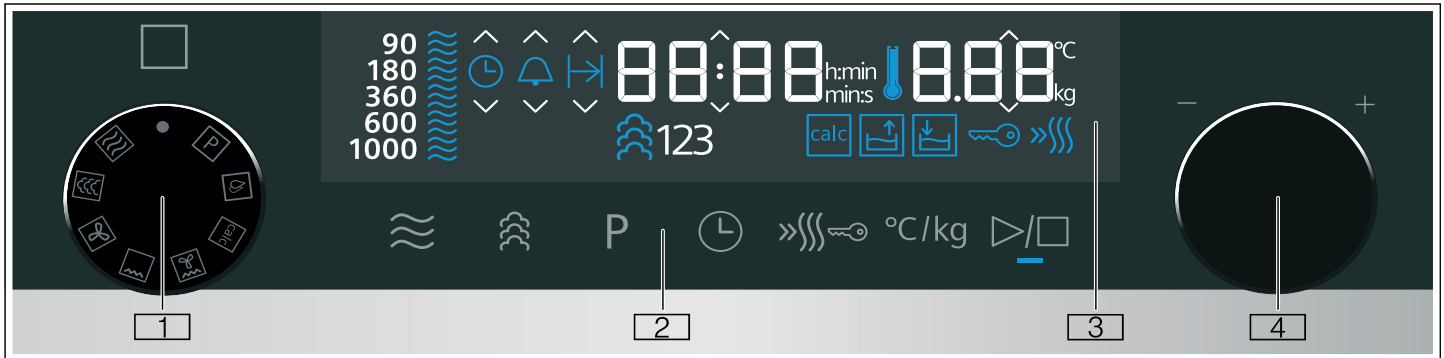

1 Function selector

Use the function selector to set the type of heating or other functions. You can turn the function selector clockwise or anti-clockwise from the "Off" position.

2 Touch fields

There are sensors behind the touch fields. Simply touch a symbol to select the function.

3 Display

The display shows symbols for active functions and the time-setting options.

4 Rotary selector

Use the rotary selector to set the temperature for the heating type or select the setting for other functions.

You can turn the rotary selector clockwise and anti-clockwise.

Notes

- On some appliances, the function or rotary selector can be retracted. To pop the function or rotary selector in or out, push it in in the "Off" position.
- If the function selector is in the "Off" position (energy-saving mode) and a function is selected, it will take a few seconds before the function becomes available (e.g. the microwave).

Function selector

Use the function selector to set the operating modes and other functions.

To make sure you always use the right operating mode to cook your food, we have explained the differences and applications below.

Position	Use
● "Off" position	In this position, the appliance is switched off and is in energy-saving mode.
☰ Microwave	Select microwave mode.

Control panel

Use the function and rotary selector, as well as the touch fields, to set the various functions for your appliance via the control unit. The current settings are shown in the display.

The overview shows the control panel when the appliance is switched on with a selected operating mode.

☁	Steam	Hot steam is fed into the cooking compartment.
☁	Convection	The fan distributes the heat from the ring heating element in the back panel evenly around the cooking compartment.
☰	Grill	The whole area below the grill elements becomes hot.
☁	Hot air grill	The fan circulates the hot air from the grill elements around the food.
calc	Descaling	Used to descale the evaporator and keep it operational.
☰	Rinse	This function rinses the pipes in the steam unit with water. It is recommended to carry out the rinse function after each steam operation.
P	Programmes	This gives you access to preprogrammed settings for many dishes.

Touch fields and display

You can use the touch fields to set various additional functions for your appliance. You can see the values for these in the display.

Touch fields

Here you can find a short explanation of the various buttons and touch fields.

Symbol	Meaning
☰	Microwave Select the microwave power levels or switch on the microwave function for a type of heating.
☁	Steam Select a steam level or switch on the steam function for a type of heating.

	Programmes	Call up the programme selection, use the rotary selector to select the programme number.
	Time-setting options	Select the "Time-setting options" symbol and use the rotary selector to set the time-setting options you require.
	Rapid preheating/childproof lock	Press briefly: Activate/deactivate rapid preheating. Press and hold: Activate/deactivate the childproof lock.
	Temperature/weight	Select and set the temperature/weight using the rotary selector.
	Start/stop	Starts or pauses the operation Note: Pressing and holding ends the current operation and the settings for the operating mode selected are reset to the default values.

Display

The display is structured so that the information can be read at a glance in any situation.

The value that you can currently set is highlighted. It is highlighted by two small arrows above and below the set value.

The value that is highlighted can be changed directly using the rotary selector.



Display elements

Here you can find a short explanation of the various display elements.

Symbol		Meaning
	Timer	If the symbol is highlighted, the timer will appear on the display.
	Cooking time	If the symbol is highlighted, the cooking time will appear on the display.
	Clock	If the symbol is highlighted, the clock will appear on the display.
h:min	Hours/minutes	Cooking time in hours and minutes
min:s	Minutes/seconds	Cooking time in minutes and seconds
	Childproof lock	If this symbol lights up, the childproof lock is activated.
	Waste water tank	Waste water tank status display
	Water tank	Water tank status display
	Rapid heating	If this symbol lights up, rapid heating is activated.
	Descaling	If the symbol lights up, the appliance must be descaled.

Waste water tank and water tank status display

The status display only lights up when the waste water tank or water tank is required for the selected operating mode. It can display various statuses and informs the user when action is required.

Water tank status display

Symbol		Meaning
	Symbol lights up, arrow flashes	Water tank is in the tank recess and needs filling.
	Symbol without arrow flashes	Water tank is not in the tank recess and needs fitting in place.
	Symbol without arrow lights up	Water tank is in the tank recess. No further action necessary.

Waste water tank status display

Symbol		Meaning
	Symbol lights up, arrow flashes	Waste water tank is in the tank recess and needs emptying.
	Symbol without arrow flashes	Waste water tank is not in the tank recess. Insert the waste water tank into the tank recess.
	Symbol without arrow lights up	Waste water tank is in the tank recess. No further action necessary.

Temperature indicator

The blue thermometer to the right of the time display shows that the appliance is heating up.

If a heating function is in use, the thermometer turns blue in four stages as the heating compartment heats up.

If you are using the grill or steam mode, the entire thermometer lights up blue immediately.

The thermometer does not light up when the microwave function is in use.

When you are preheating the appliance, the optimal time to place your food in the cooking compartment is as soon as the thermometer has turned completely blue.

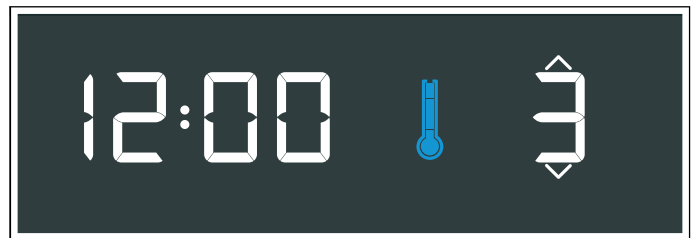

Note: Due to thermal inertia, the actual temperature inside the cooking compartment may be slightly different to the temperature that you set.

Night mode

To save energy, the display brightness is automatically reduced to a lower level between 10 p.m. and 5.59 a.m.

Rotary selector

Use the rotary selector to change the adjustment values that are shown in the display and highlighted.

In most selection lists, e.g. programmes, the first selection follows the last.

For values, e.g. weight, you have to turn the rotary selector back the other way when you reach the minimum or maximum value.

Operating modes

Your appliance has various operating modes which make your appliance easier to use.



You can find more precise descriptions of these in the corresponding sections.

Operating mode	Use
Types of heating → "Operating the appliance" on page 15	There are various finely tuned heating types for the optimal preparation of your food.
Microwave → "Microwave" on page 16	You can use the microwave to cook, heat up or defrost your dishes more quickly.
Steam → "Steam" on page 19	There are various finely tuned steam levels for the optimal preparation of your food.
Microwave combined operation → "Setting the microwave to combined operation" on page 18	In addition to a type of heating, you can switch the microwave on for this.
Steam combination → "Setting the steam combination" on page 20	In addition to a type of heating, you can switch the steam function on for this.
Cleaning → "Cleaning function" on page 30	Different cleaning functions are available: Descaling and rinsing.
Basic settings → "Basic settings" on page 28	You can change your appliance's basic settings to suit your needs.

Types of heating

To make sure you always use the right type of heating to cook your food, we have explained the differences and applications below.

The symbols for each type of heating help you to remember them.

Type of heating	Temperature	Use
 Hot air	40 °C	Let yeast dough rise, defrost cream cakes.
	100-230 °C	For baking and roasting on one level.
 Grill	Grill settings: 1 = low 2 = medium 3 = high	For grilling flat items, such as steaks or sausages, for making toast, and for au gratin dishes.
 Hot air grilling	100-190 °C	For roasting poultry, whole fish and larger pieces of meat.

Default values

For each type of heating, the appliance specifies a default temperature or level. You can accept this value or change it in the appropriate area.

Steam

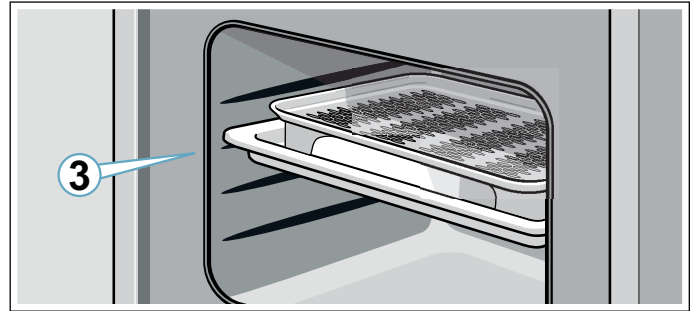

You can use the steam function on its own or in combination with all types of heating and the microwave function.

To ensure optimum use of the steam function, remove the wire rack. Insert the glass tray at shelf position 3 and insert the steam container into the glass tray.



Steam levels

Different intensity levels are available when using the steam function. The steam levels can be selected by touching . The selected steam level is shown in the display.

Level	Intensity	Use	Display indicator
1	low	For defrosting vegetables, meat, fish and fruit.	 123
2	medium	For preparing desserts, fish and sausages.	 123
3	high	For cooking vegetables, fish, side dishes, for extracting juice from fruit and for blanching.	 123

Microwave

A variety of microwave power settings that are suitable for different types of food and food preparation are available. The microwave settings do not always correspond exactly to the wattage used by the appliance.

The following microwave settings are available.

Microwave setting	Maximum cooking time
90	1 hour 30 mins
180	1 hour 30 mins
360	1 hour 30 mins
600	1 hour 30 mins
1000	30 minutes

You can use the microwave function on its own or in combination with all types of heating and the steam function.

Exceptions:

- ☒ Microwave setting, 1000 watts
- ☒ Hot air 40 °C

Find out how to combine the microwave function with all types of heating and the steam function here:
 → "Setting the microwave to combined operation" on page 18

Cooking compartment

Various functions in the cooking compartment make your appliance easier to use. For example, the cooking compartment is well lit and a cooling fan prevents the appliance from overheating.

Opening the appliance door

If you open the appliance door during an operation, the operation is paused. Close the door and touch the >/□ field to continue the operation.

Interior lighting

The interior lighting lights up while the appliance is operating. Once the oven has finished cooking the food, the lighting goes out.

The interior lighting switches on when the appliance door is opened. This makes it easier to clean your appliance, for example. After approximately 15 minutes, the interior lighting automatically switches itself off.

Cooling fan

Your appliance has a cooling fan. The cooling fan switches on during operation. The hot air escapes above the door.

The cooling fan continues to run for a certain time after operation.

Caution!

Do not cover the ventilation slots. Otherwise, the appliance may overheat.

Notes

- The appliance remains cool during microwave operation. Despite this, the cooling fan will still switch on. The fan may run on even when microwave operation has ended.
- Condensation may form on the door window, interior walls and floor. This is normal and does not adversely affect appliance operation. Wipe away the condensation after cooking.

Tank cover

The tank cover is located below the appliance door and allows for access to the waste water tank and water tank. Both of these are located behind the tank cover. Proceed as follows to open and close the tank cover:

Briefly press on the centre of the tank cover to open it. The tank cover folds upwards.

To close the tank cover, fold it downwards and briefly press the centre of the tank cover. The tank cover is locked.

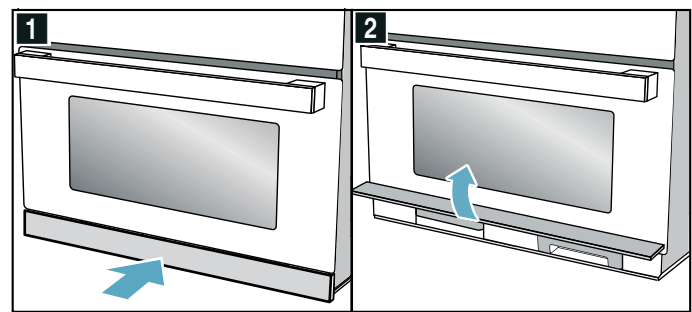

Water tank

The appliance is equipped with a water tank. The water tank is located to the right behind the tank cover. Fill the water tank with water to operate the appliance using steam modes. → "Filling the water tank" on page 20

If the arrow of the water tank symbol ☒ flashes on the display, the water in the water tank needs replacing.

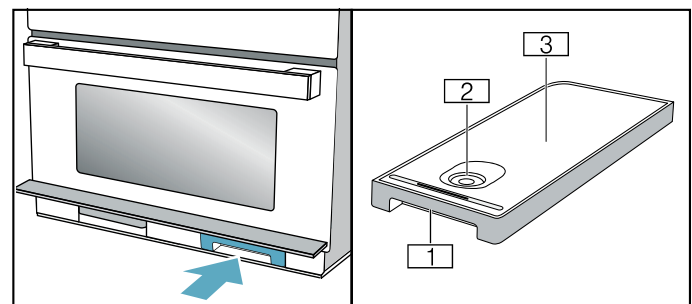

- 1 Handle for removing and inserting the water tank
- 2 Opening for filling
- 3 Tank cover

Waste water tank

The appliance is equipped with a waste water tank. The waste water tank is located to the left behind the tank cover. Empty the waste water tank before and after carrying out the cleaning functions → "Cleaning function" on page 30

If the arrow of the waste water tank symbol ☒ flashes on the display, the waste water tank needs emptying.

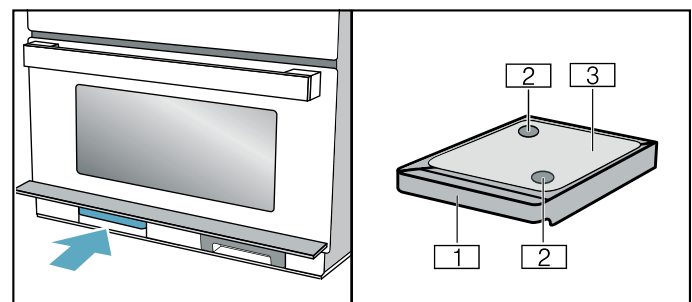

- 1 Handle for removing and inserting the waste water tank
- 2 Collection opening
- 3 Tank cover

Accessories

Your appliance is accompanied by a range of accessories. Here, you can find an overview of the accessories included and information on how to use them correctly.

Accessories included

Your appliance is equipped with the following accessories:

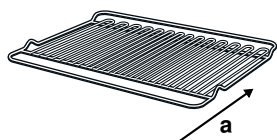

Wire rack

Use as a surface for setting down baking tins or for grilling and browning. The wire rack is not suitable for use when the appliance is operating either in microwave only mode or in steam only mode. Make sure that you insert the wire rack in direction a.



Glass tray

The glass tray can be used for cooking in all operating modes, including combination mode. In addition, it acts as a splash guard if you are grilling food directly on the wire rack. Allow the glass tray to cool before you clean it or place it in cold water as this may damage the glass.



Steam container

The steam container is placed into the glass tray in order to cook with the "Steam" or "Steam with microwave" operating modes. The glass tray must be inserted in shelf position 3 for this. The food can be placed directly onto the steam container. The steam container is dishwasher-safe. Do not use the steam container in standard microwave operation or during "Grill", "Hot air" or "Hot air grill" heating modes.

Only use original accessories provided by your appliance manufacturer. They are specially adapted for your appliance.

You can buy accessories from our customer service, from specialist retailers or online.

Additional accessories

Additional accessories may be enclosed depending on the appliance model.

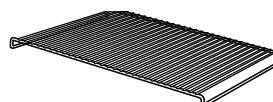

Wire insert

For frying. Insert the wire insert into the glass tray with its feet to the bottom. This ensures that dripping grease and meat juices can be collected. The wire insert is not suitable for use in microwave operation or steam mode.

Special accessories

You can obtain further accessories from the after-sales service or from specialist retailers.

Special accessories

Glass roasting dish

For pot roasts and bakes that you prepare in the oven.

Inserting accessories

The cooking compartment has four shelf positions. The shelf positions are counted from the bottom up.

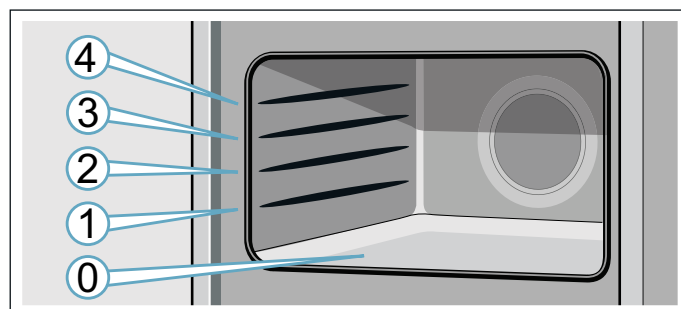

Insert the accessory into the guide and slide it in fully.

Note: The cooking compartment (position 0) is particularly suitable for microwave operation, as this is where the microwave power is optimum. Only use cookware that is suitable for use in microwaves.



Before using for the first time

Before you can use your new appliance, you must make some settings. You must also clean the cooking compartment and accessories.

The appliance must be fully installed and connected to the mains.

Initial use

After connecting the electricity supply or after a power cut, the display prompts you to set the time.

Setting the time

During initial use, the time display is highlighted. The 12:00 value flashes in the display and the ☹ symbol lights up. Set the time.

1. Use the rotary selector to set the time.
2. Touch ☹.
The time has now been set.

Changing the time on the clock

Note: To change the time on the clock, you will need to switch off the appliance.

1. Touch the ☹ button twice.
The ☹ symbol and the clock time will appear on the display.
2. Set the clock using the rotary selector.
3. Touch the ☹ button.
The time has now been set.

Notes

- If you do not touch the ☹ button after setting the time, the set value is automatically adopted after a few seconds.
- If the function selector has been moved to configure the settings, it must be returned to the "Off" position once you have finished. Only then can the appliance be used.
- In order to reduce the energy consumption of your appliance in standby, you can hide the clock.

Set the water hardness range.

So that the appliance can reliably remind you to descale it when required, you must set your water hardness range correctly.

The water hardness range is set to 4 (very hard) by default.

Caution!

The appliance may become damaged due to the use of unsuitable liquids.

Do not use distilled water, highly chlorinated tap water (>40 mg/l) or other liquids.

Only use fresh, cold, non-carbonated tap water or softened water.

Notes

- If your water is very hard, we recommend that you use softened water.
- If you only use softened water, you can set the water hardness range to "softened" in this case.
- If you use mineral water, set the water hardness range to "4 very hard".
- If you use mineral water, you must only use non-carbonated mineral water.

Water hardness range	Setting
0	0 softened
1 (up to 1.3 mmol/l)	1 soft
2 (1.3 - 2.5 mmol/l)	2 medium
3 (2.5 - 3.8 mmol/l)	3 hard
4 (above 3.8 mmol/l)	4 very hard

You can change the water hardness in the basic settings. → "Basic settings" on page 28

Cleaning the cooking compartment and accessories

Before using the appliance to prepare food for the first time, you must clean the cooking compartment and accessories.

Cleaning the cooking compartment

To eliminate the new-appliance smell, heat up the cooking compartment when it is empty and with the oven door closed. One hour with Hot air  at 180 °C is ideal for this. Ensure that no packaging remnants have been left in the cooking compartment.

1. Use the function selector to set Hot air .
2. Use the rotary selector to set to 180 °C.
3. Touch ▷/□.

The appliance begins to heat up.

Switch off the appliance after one hour. To do so, touch ▷/□ and then turn the function selector to the off position.

Cleaning the accessories

Before you use the accessories for the first time, clean them thoroughly with hot soapy water and a soft dish cloth.

Operating the appliance

You have already learnt about the controls and how they work. Now we will explain how to set your appliance. You will learn about what happens when you switch the appliance on and off, and how to select the operating mode.

Switching the appliance on and off

Before you are able to set the appliance, you must switch it on.

Note: The childproof lock can only be set if the appliance is switched off. Some displays also remain visible in the display when the appliance has been switched off.

Switch off your appliance when it is not being used. If no settings are applied for a long time, the appliance switches itself off automatically.

Switching on the appliance

Turn the function selector to switch on the appliance.

A standard value is highlighted in the display. The appliance is ready to use.

You can find out how to select the operating modes in the individual chapters.

Switching off the appliance

Turn the function selector to the off position.

Any functions that may be running are cancelled.

The time appears in the display.

Note: You can set whether the clock should be displayed when the device is switched off in the basic settings.

Selecting an operating mode

After selecting an operating mode, default values are shown in the display. You can start this setting immediately.

The following always applies:

1. Use the function selector to select the operating mode.
2. If necessary, apply other settings.
To do this, touch the appropriate field and use the rotary selector to change the value.
3. Touch ▷/□.
The appliance starts the operation. The ▷/□ LED lights up.

Setting the heating function and temperature

Example: Hot air  at 200 °C

1. Use the function selector to set the Hot air  heating function.
A default temperature of 160 °C will appear on the display.

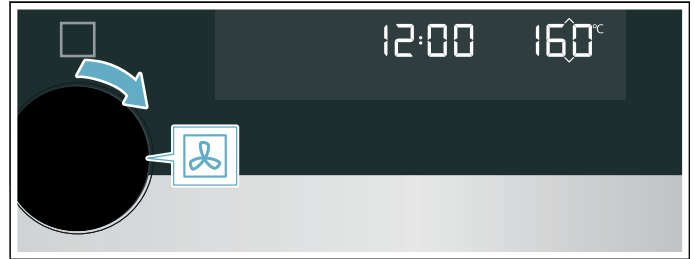

2. Use the rotary selector to set the temperature to 200 °C.
3. Touch the ▷/□ button.



The appliance will start heating. The ▷/□ LED will be lit. The length of the bar on the temperature indicator gradually increases.

You can change the temperature at any time when the appliance is heating using the rotary selector.

Notes

- Once the appliance has heated up, slight fluctuations in temperature are normal, depending on the heating function.
- When the appliance is heating, the temperature cannot be set to 40 °C.

Setting the cooking time

1. Set the type of heating and temperature.
2. Touch ⊖ until the I→ symbol is highlighted.
3. Use the rotary selector to set the required cooking time.
4. Touch ▷/□.
The appliance begins to heat up. The ▷/□ LED lights up. The cooking time starts counting down.

Pausing the operation

1. Touch the ▷/□ field or open the appliance door.
The operation is suspended and the ▷/□ LED flashes.
2. Close the appliance door.
3. Touch the ▷/□ field.
The operation is continued and the ▷/□ LED lights up.

Stopping the appliance from heating

Turn the function selector to the "Off" position.



The appliance will stop heating and all the settings will be cleared.

Note: The fan may continue to run after the appliance has been paused or stopped.





Rapid heating

With rapid heating, your appliance reaches the set temperature particularly quickly.

Rapid heating is available for the following types of heating:

-  Hot air (Exception: Hot air 40 °C)
-  Hot air grill



To ensure an even cooking result, do not place your food in the cooking compartment until rapid heating is complete.

1. Set the type of heating and temperature.
2. Touch . The  symbol lights up on the display.
3. Touch . The appliance begins to heat up. The  LED lights up.

Rapid heating has finished

An audible signal sounds. The  symbol disappears from the display. Your appliance continues to run with the set type of heating and temperature. Place your food in the cooking compartment.

Cancelling rapid heating

Touch . The  symbol disappears from the display. Your appliance continues to run with the set type of heating and temperature.

Note: Rapid heating is automatically deactivated within 15 minutes maximum.

Automatic safety switch-off function

The automatic safety switch-off function is activated if your appliance is operating for a long time with no cooking time having been set.

The appliance automatically switches off after nine hours.

Microwave

You can use the microwave to cook, heat up or defrost food quickly. You can use the microwave on its own or in combination with other types of heating.

To ensure optimum use of the microwave, please observe the notes on cookware and familiarise yourself with the data in the application tables at the end of the instruction manual.

To ensure optimum use of the microwave, place your cookware on the cooking compartment floor. Remove the wire rack. Observe the instructions on the cookware.

Cookware

Not all cookware is microwavable. So that your food is heated and the appliance is not damaged, only use microwavable cookware.

Suitable cookware

Heat-resistant cookware made of glass, glass ceramic, porcelain, ceramic or heat-resistant plastic are suitable. These materials allow microwaves to pass through.

You can also use serving dishes. This saves you having to transfer food from one dish to another. You should only use cookware with decorative gold or silver trim if the manufacturer guarantees that they are suitable for use in microwaves.

Unsuitable cookware

Metal cookware is unsuitable. Metal does not allow microwaves to pass through. Food in covered metal containers will remain cold.

Caution!

Creation of sparks: Metal – e.g. a spoon in a glass – must be kept at least 2 cm from the cooking compartment walls and the inside of the door. Sparks can irreparably damage the glass on the inside of the door.

Cookware test

Never switch on the microwave unless there is food inside. The short cookware test is the only exception to this rule.

Perform the following test if you are unsure whether your cookware is suitable for use in the microwave.

1. Heat the empty cookware at maximum power for ½ to 1 minute.
2. Check the temperature of the cookware during this time.

The cookware should remain cold or warm to the touch.

The cookware is unsuitable if it becomes hot or sparks are generated.

In this case, stop the test.

Warning – Risk of burns!

The accessible parts become very hot when in operation. Never touch hot parts. Keep children at a safe distance.

Microwave power settings

The microwave power settings are levels and do not always correspond to the exact wattage that the appliance uses.

The following microwave power settings are available.

Micro-wave setting	Maximum cooking time	Use
90	1 hour 30 mins	For defrosting food that deteriorates easily in terms of quality.
180	1 hour 30 mins	For defrosting and continued cooking.
360	1 hour 30 mins	For cooking meat and for heating food that deteriorates easily in terms of quality.
600	1 hour 30 mins	For heating and cooking food.
1000	30 minutes	For heating liquids.

Default settings:

The appliance suggests a cooking time for each microwave level. You can accept this value or change it in the relevant area.

The maximum setting is designed for heating liquids only; it is not designed for heating food. After a certain period, the microwave's maximum power is gradually reduced to 600 W to protect the appliance. Full power is made available again after a cooling period.

Time setting intervals

The interval for setting the cooking time changes with the length of the cooking time.

Cooking time	Interval
0 - 1 minute	5 seconds
1 - 3 minutes	10 seconds
3 - 15 minutes	30 seconds
15 minutes - 1 hour	1 minute
1 hour - 1 hour 30 minutes	5 minutes

Setting the microwave

Example: Microwave setting 600 W, cooking time 5 minutes.

- Use the function selector to select the microwave function . The appliance is now ready to use. The maximum microwave power output \approx will be displayed as the default value on the display. You can change this at any time.
- Touch the microwave setting field to select the power setting you require.

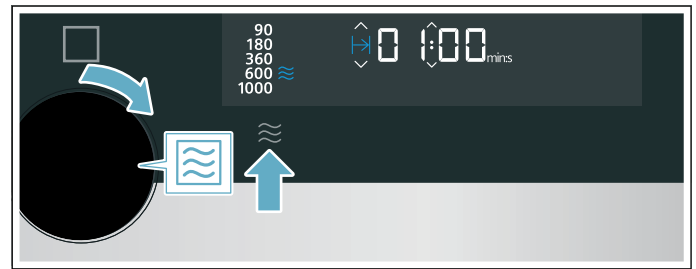

The microwave setting will be highlighted and a default cooking time will be shown on the display.

- Use the rotary selector to set the required cooking time. **Note:** You can also set the cooking time first and then the microwave setting.
- Touch the \triangleright/\square button.

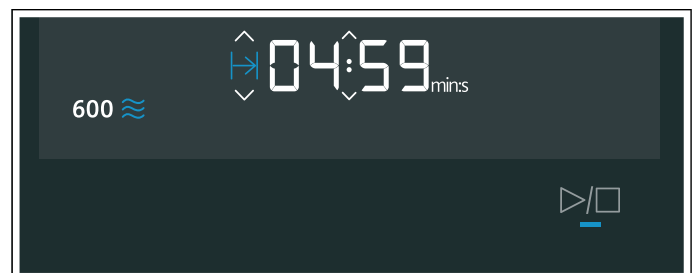
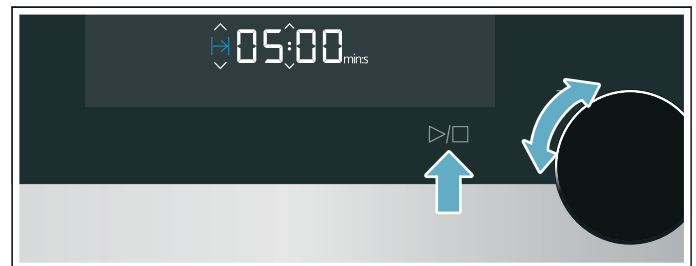

The time remaining will count down on the display. The \triangleright/\square LED will be lit.

The cooking time has elapsed

An audible signal sounds. Open the appliance door or touch any field to stop the sounds.

Changing the cooking time

Use the rotary selector to change the cooking time. After a few seconds, the change is applied.

Changing the microwave power output

Touch \approx until the required level is selected in the display.

Notes

- Touching it several times switches the power levels from the highest to the lowest level.
- If the microwave function is only added after the start, the appliance pauses. Press ▷/□ to start operation

Pausing the operation

1. Touch the ▷/□ field or open the appliance door. The operation is suspended and the ▷/□ LED flashes.
2. Close the appliance door.
3. Touch the ▷/□ field. The operation is continued and the ▷/□ LED lights up.

Stopping the appliance from heating

Turn the function selector to the "Off" position.

The appliance will stop heating and all the settings will be cleared.

Note: The fan may continue to run after the appliance has been paused or stopped.



Setting the microwave to combined operation

You can combine the microwave function with all types of heating and the steam function. The appliance heats up and the microwave is switched on at the same time. As a result, the food is ready in a much shorter time.

Combination options



-  Steam
-  Hot air
-  Grill
-  Hot air grill

Exceptions:

-  Microwave setting, 1000 watts
-  Hot air 40 °C

Setting combined operation

Example: Hot air  190 °C with microwave at 360 W, 17 minutes.

1. Use the function selector to set the Hot air  function. A default value for the temperature is displayed.
2. Turn the rotary selector to set the desired temperature.
3. Touch the microwave power output field  until the required level is selected in the display. A default cooking time appears.
4. Set the cooking time using the rotary selector.
5. Touch ▷/□. The operation starts and the ▷/□ LED lights up. The cooking time starts counting down.

The cooking time has elapsed

A signal sounds and the ▷/□ symbol stops lighting up. Combination mode has finished. Touch any field to end the acoustic signal.

Changing the microwave power output

Touch  until the required level is selected in the display.

Notes

- Touching it several times switches the power levels from the highest to the lowest level.
- If the microwave function is only added after the start, the appliance pauses. Press ▷/□ to start operation

Pausing the operation

1. Touch the ▷/□ field or open the appliance door. The operation is suspended and the ▷/□ LED flashes.
2. Close the appliance door.
3. Touch the ▷/□ field. The operation is continued and the ▷/□ LED lights up.

Stopping the appliance from heating

Turn the function selector to the "Off" position.

The appliance will stop heating and all the settings will be cleared.



Note: The fan may continue to run after the appliance has been paused or stopped.

Drying the cooking compartment

Dry the cooking compartment after operation to ensure that no moisture remains.

Heating up the cooking compartment

To dry, heat up the cooking compartment so that the moisture in the cooking compartment evaporates. Then open the appliance door to allow the steam to escape from the cooking compartment.

1. Allow the appliance to cool down.
2. Remove the worst dirt from the cooking compartment immediately and wipe away moisture from the cooking compartment floor.
3. Use the function selector to select Hot air grill .
4. Touch  twice. The cooking time symbol  is highlighted in the display.
5. Use the rotary selector to set a cooking time of 15 minutes.
6. Press ▷/□ to start the operation. The drying function starts and ends automatically after 15 minutes.
7. Open the appliance door and leave it open for 1 to 2 minutes so that the moisture in the cooking compartment can escape.

Drying the cooking compartment by hand

1. Allow the appliance to cool down.
2. Remove any food remnants from the walls of the cooking compartment.
3. Dry the cooking compartment with a sponge.
4. Leave the appliance door open for 1 hour so that the cooking compartment dries completely.

Steam

You can use the steam function on its own or in combination with all types of heating and the microwave function.

To ensure optimum use of the steam function, remove the wire rack. Insert the glass tray at shelf position 3 and insert the steam container into the glass tray.

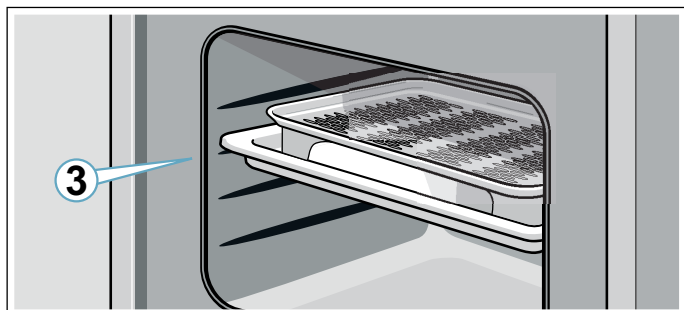

⚠ Warning – Risk of scalding!

When you open the appliance door, hot steam can escape. Steam may not be visible, depending on its temperature. When opening, do not stand too close to the appliance. Open the appliance door carefully. Keep children away.

Noise

Pump

You will hear a humming noise during operation. This noise is caused by the pump. It is a normal operating noise.

Cooking with steam

Steam levels

Different intensity levels are available when using the steam function. The steam levels can be selected by touching . The selected steam level is shown in the display.

Level	Intensity	Use	Display indicator
1	low	For defrosting vegetables, meat, fish and fruit.	123
2	medium	For preparing desserts, fish and sausages.	123
3	high	For cooking vegetables, fish, side dishes, for extracting juice from fruit and for blanching.	123

Setting the steam

Note: If the appliance has not been used for an extended period, start by running a rinse cycle . → "Cleaning function" on page 30

Example: Steam setting 2: Medium, cooking time 10 minutes.

1. Use the function selector to select the steam function .



The appliance is ready to use. The maximum steam setting and a cooking time of 20 minutes are set as the default values. The arrow of the water tank symbol flashes.

2. Remove the water tank, fill with fresh water up to the "max." mark and insert fully in the tank recess. → "Filling the water tank" on page 20
3. Touch and hold the button until you reach the required setting.

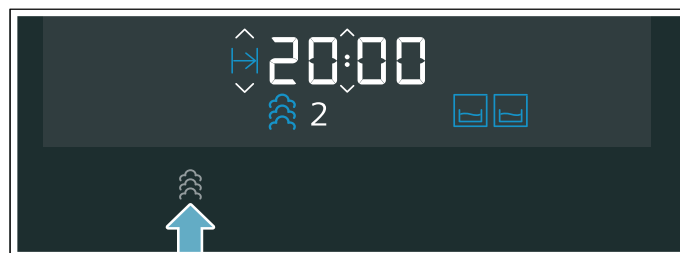

The selected steam setting will be shown on the display.

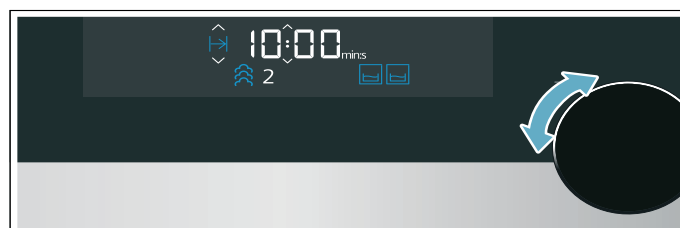

4. Use the rotary selector to set the required cooking time.

Note: You can also adjust the cooking time first and then the steam setting.



5. Touch the ▷/□ button.



The arrow of the water tank symbol  will go out and the water tank symbol  will be lit. The appliance will start. The ▷/□ LED will be lit. The cooking time will count down on the display. The amount of time a tankful of water will last varies depending on the steam setting. If the water tank runs out of water while the appliance is in operation, the appliance is paused and the arrow of the water tank symbol  flashes. Fill the water tank with fresh water up to the "max." mark and touch the ▷/□ button to resume operation.

Notes

- The steam setting can be changed at any time when the appliance is in operation by pressing the  button.
- After cooking with steam, wipe out the drip channel and the cooking compartment. → "After every steam operation" on page 21

Setting the steam combination

With some types of heating, you can switch on the steam function.

When you cook with steam assistance, steam is introduced into the cooking compartment at various intervals and with varying degrees of intensity. This gives you a better cooking result.

Your food

- Becomes crispy on the outside
- Achieves a glossy surface
- Is succulent and tender on the inside
- Only undergoes a minimum reduction in volume

Combination options



-  Microwave
-  Hot air
-  Grill
-  Hot air grill

Exceptions:

-  Microwave setting, 1000 watts
-  Hot air 40 °C

Setting combination mode

Example: Hot air  190 °C with steam setting 2.

1. Use the function selector to set the Hot air  heating function.
A default value for the temperature will be displayed.
2. Turn the rotary selector to set the desired temperature.
3. Touch the Steam button  until the required setting has been selected on the display.
The water tank symbol  will appear on the display.

4. Refill water tank.
5. Touch the ▷/□ button.
The appliance will start and the ▷/□ LED will be lit. The cooking time will start counting down.

Notes

- If the water tank runs out of water during cooking, the appliance will continue cooking, but without steam assistance. No indicator will appear on the display.
- Opening the appliance door affects the cooking result. Always keep the appliance door closed when cooking.

The cooking time has elapsed

A signal sounds and the ▷/□ symbol stops lighting up. Combination mode has finished. Touch any field to end the acoustic signal.

Changing the steam level

Touch the  field until the required level is selected in the display.

Note: Touch the field multiple times switches through the levels from the highest to the lowest level. After the lowest level, the steam function is deactivated. Touching again activates the steam function, starting with the highest level.

Pausing the operation

1. Touch the ▷/□ field or open the appliance door.
The operation is suspended and the ▷/□ LED flashes.
2. Close the appliance door.
3. Touch the ▷/□ field.
The operation is continued and the ▷/□ LED lights up.

Stopping the appliance from heating

Turn the function selector to the "Off" position.

The appliance will stop heating and all the settings will be cleared.

Note: The fan may continue to run after the appliance has been paused or stopped.

Filling the water tank

The water tank is located to the right behind the tank cover, below the appliance door. Before starting an operation with steam, open the tank cover and fill the water tank with water.

Ensure that the water hardness range has been set correctly. → "Basic settings" on page 28

Warning – Risk of injury and fire!

Only fill the water tank with water. Do not pour any flammable liquids (e.g. alcoholic drinks) into the water tank. Due to hot surfaces, vapours from flammable liquids may catch fire in the cooking compartment (explosion). The appliance door may spring open. Hot steam and jets of flame may escape.

Caution!

The appliance may become damaged due to the use of unsuitable liquids.

Do not use distilled water, highly chlorinated tap water (>40 mg/l) or other liquids.

Only use fresh, cold, non-carbonated tap water or softened water.

Notes

- If your water is very hard; we recommend that you use softened water.
- If you use only softened water, you can set your appliance to the "softened" water hardness range.

1. Briefly press on the centre of the tank cover. The tank cover will open. The waste water tank (left) and water tank (right) can now be accessed.
2. Remove the water tank from the tank recess.

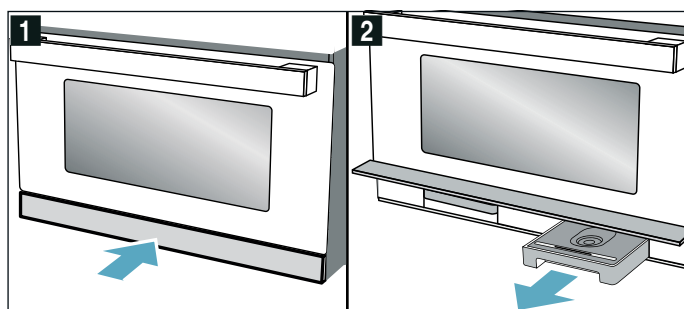

3. Fill the water tank with cold water up to the "max." mark.

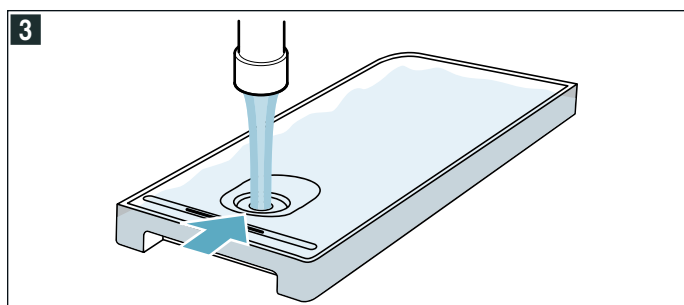

4. Place the water tank back into the tank recess and slide it in fully.
5. Close the tank cover.

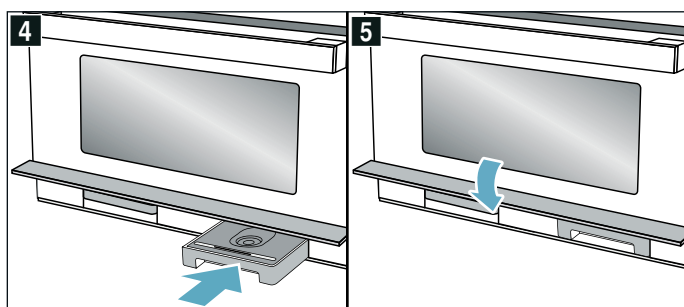

The steam function is ready to use.

Refilling the water tank

The way the appliance responds if the water tank runs dry when the appliance is in operation depends on what operating mode it is in:

- Steam-assistance mode: The appliance is stopped and a message appears on the display. At the highest steam setting, a tankful of water will last approx. 30-40 minutes; at the lower steam settings, it will last much longer.
- Steam-assistance with microwave: The appliance is stopped. A tankful of water will last approx. 50 minutes.
- Steam-assisted hot-air or grill mode: The appliance continues to run in hot-air or grill mode; no message appears on the display. At the highest steam setting, a tankful of water will last approx. 3 hours; at the lower steam settings, it will last much longer.
- Steam-assisted air recirculation grill mode: The appliance continues to run in air recirculation grill mode; no message appears on the display. A tankful of water will last approx. 9 hours.

Note: Actual times may vary from those specified.

Refill the water tank up to the "MAX" mark.

1. Open the control panel.
2. Remove and refill the water tank.
3. Insert the filled water tank and close the control panel.

After every steam operation

Moisture remains in the cooking compartment. Carefully wipe out the drip channel and the cooking compartment. Each time you cook using steam, we recommend that you run the Rinse cleaning function  afterwards. Then empty and dry the water tank and waste water tank.

Note: Remove limescale marks with a cloth soaked in vinegar, then wipe with clean water and dry with a soft cloth.

Rinsing

To ensure that your appliance stays clean, you can pump water through the pipe system. The water is then drained to the waste water tank.

Note: After rinsing, there can be dissolved lime particles in the waste water tank. This is normal and does not affect operation.

Starting

1. Use the function selector to select the rinse cycle . The duration of the programme will be displayed. It cannot be changed.
2. Open the tank cover.
3. Remove and empty the waste water tank.
4. Slide the empty waste water tank in fully.
5. Remove water tank and drain any residual water. Rinse out water tank thoroughly and fill with fresh water.
6. Slide the water tank in fully.
7. Close the tank cover.

8. Touch the ▷/□ button.
Water is pumped through the pipes. The time remaining will count down on the display. An audible signal will sound once this time has elapsed. Empty the waste water tank.

Emptying the water tank

1. Briefly press on the centre of the tank cover.
The tank cover folds upwards.
2. Remove the water tank.
3. Carefully remove the lid for the water tank.
4. Empty the water tank, clean it with detergent and then rinse it thoroughly with clean water.
5. Dry all parts with a soft cloth.
6. Rub the seal on the lid until dry.
7. Allow the water tank to dry with the lid open.
8. Place the lid on the water tank and push down on it.
9. Slide the water tank in fully.
10. Close the tank cover and briefly press on the centre of it.
The tank cover is locked.

Caution!

- Do not dry the water tank in the hot cooking compartment. This will damage the water tank.
- Do not clean the water tank in the dishwasher. This will damage the water tank.

Cleaning the drip tray

1. Allow the appliance to cool down.
2. Open the tank cover.
3. Remove the water tank and waste water tank.
4. Wipe around the drip tray **a** underneath the cooking compartment with a sponge cloth (fig. **1**).

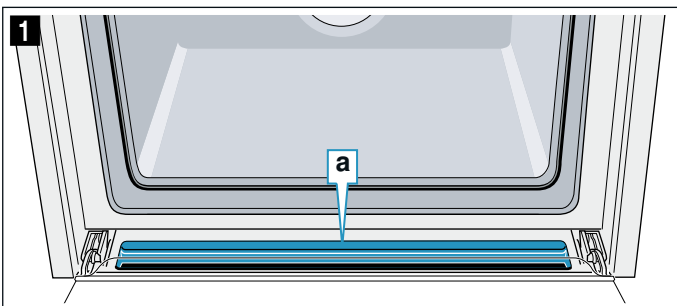

Drying the cooking compartment

Dry the cooking compartment after operation to ensure that no moisture remains.

Heating up the cooking compartment

To dry, heat up the cooking compartment so that the moisture in the cooking compartment evaporates. Then open the appliance door to allow the steam to escape from the cooking compartment.

1. Allow the appliance to cool down.
2. Remove the worst dirt from the cooking compartment immediately and wipe away moisture from the cooking compartment floor.
3. Use the function selector to select Hot air grill .
4. Touch ⊖ twice.
The cooking time symbol I→I is highlighted in the display.

5. Use the rotary selector to set a cooking time of 15 minutes.
6. Press ▷/□ to start the operation.
The drying function starts and ends automatically after 15 minutes.
7. Open the appliance door and leave it open for 1 to 2 minutes so that the moisture in the cooking compartment can escape.

Drying the cooking compartment by hand

1. Allow the appliance to cool down.
2. Remove any food remnants from the walls of the cooking compartment.
3. Dry the cooking compartment with a sponge.
4. Leave the appliance door open for 1 hour so that the cooking compartment dries completely.

Automatic programmes

You can prepare food really easily using the automatic programmes. You select the programme and enter the weight of your food. The automatic programme then applies the most suitable settings. You can select from 30 programmes.

Notes

- Take the food out of its packaging and weigh it. If it is not possible to enter the exact weight, you should round it up or down.
- Place the food in the cold cooking compartment.
- For the programmes, always use microwaveable, heat-resistant cookware, for example made of glass or ceramic. Observe the accessories tips in the programme table.
- For an optimal cooking result, use food that is in good condition and chilled meat only. For frozen food, use food straight out of the freezer only.

Setting a programme

Example in diagram: Programme 3 with a weight of 1 kg.

1. Set the function selector to **P** automatic programmes.
The first programme number and weight suggestion are shown in the display.

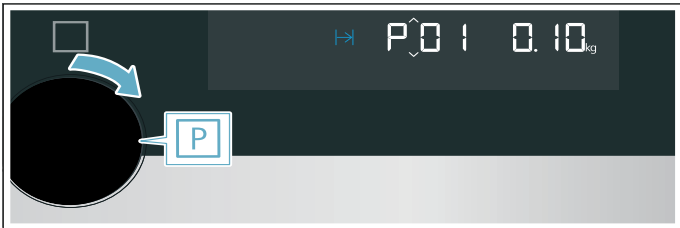

2. Use the rotary selector to select programme number 3.

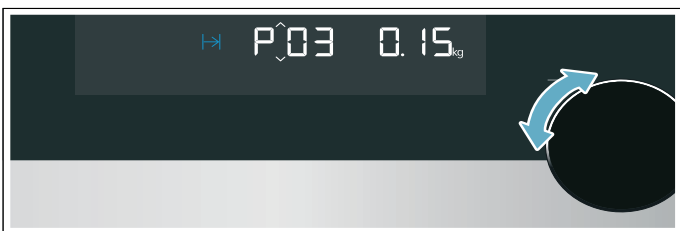

3. Touch kg.
The weight setting is highlighted in the display.

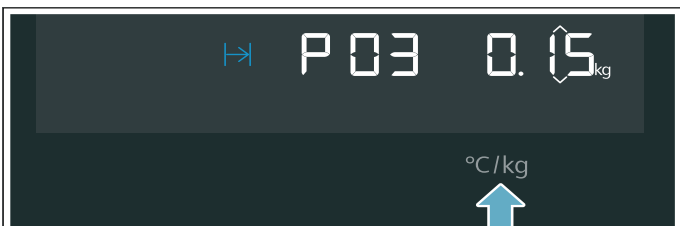

4. Use the rotary selector to set the weight to 1 kg.
The appliance automatically sets the right cooking time for that weight.



5. Touch ▷/□.
The programme will start. The cooking time visibly counts down and the temperature bar and the ▷/□ LED light up.

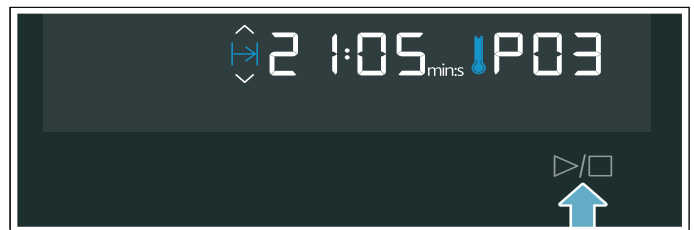

Notes

- Before starting you can use **P** and °C/kg to switch between programmes and weight.
- Once you have started the programme, the programme number and weight cannot be changed. You can check the set weight by touching °C/kg.

The programme has ended

An audible signal sounds. The programme has finished; the appliance stops heating. Turn the function selector to the off position.

Changing the programme

1. Touch the ▷/□ field for approx. four seconds.
The programme is reset.
2. Select a new programme.

Pausing the operation

1. Touch the ▷/□ field or open the appliance door.
The operation is suspended and the ▷/□ LED flashes.
2. Close the appliance door.
3. Touch the ▷/□ field.
The operation is continued and the ▷/□ LED lights up.

Stopping the appliance from heating

Turn the function selector to the "Off" position.

The appliance will stop heating and all the settings will be cleared.

Note: The fan may continue to run after the appliance has been paused or stopped.

Programme table



Pro-gramme	Meal	Weight in kg	Cookware/accessories, shelf height	Information	Specific details
Defrosting					
P 01	Minced meat*	0.10 - 1.20	Flat, shallow cookware without lid Cooking compartment floor	Use microwave-safe cookware only.	Minced beef, lamb, pork; after turning, remove any minced meat that has already defrosted
P 02	Fish fillet*	0.10 - 1.00	Flat, shallow cookware without lid Cooking compartment floor	Use microwave-safe cookware only.	Fillet of pike, cod, ocean perch, pollock, pike-perch
P 03	Chicken pieces on the bone*	0.15 - 1.20	Flat, shallow cookware without lid Cooking compartment floor	Use microwave-safe cookware only.	Skin side down
P 04	Bread slices*	0.10 - 0.50	Flat, shallow cookware without lid Cooking compartment floor	Use microwave-safe cookware only.	Wheat bread, wheat-rye bread, whole-meal bread; bread should only be defrosted in the required amounts, as it quickly becomes stale. If possible, separate the slices.
Poultry, Meat, Fish					
P 05	Chicken pieces, fresh*	0.15 - 1.00	Wire rack + glass tray Positions 3 + 2	Use microwave-safe cookware only.	Chicken thigh, half chicken, skin side down
P 06	Sirloin, rare	0.50 - 2.00	Glass tray Position 1		
P 07	Roast beef, medium	0.50 - 2.00	Glass tray Position 1		
P 08	Sirloin, well done	0.50 - 2.00	Glass tray Position 1		
P 09	Leg of lamb on the bone, medium rare	1.00 - 2.00	Glass tray Position 1		
P 10	Leg of lamb on the bone, well done	1.00 - 2.00	Glass tray Position 1		
P 11	Fish, whole, fresh	0.20 - 1.20	Steaming tray + glass tray Position 3	Fill the water tank.	Drizzle the inside with lemon juice.
P 12	Fish fillet, fresh	0.20 - 0.50	Steaming tray + glass tray Position 3	Fill the water tank.	
P 13	Fish fillet, frozen	0.20 - 0.50	Steaming tray + glass tray Position 3	Use fish fillets of equal thickness. Fill the water tank.	
P 14	Casserole, made with fresh ingredients**	0.50 - 2.00	Cookware with lid Cooking compartment floor	Use microwave-safe cookware only.	Use equal quantities of meat, vegetables and stock and enter the total weight.
Vegetables and side dishes					
P 15	Broccoli, fresh	0.10 - 1.00	Steaming tray + glass tray Position 3	Fill the water tank.	
P 16	Peas, frozen	0.10 - 1.00	Steaming tray + glass tray Position 3	Fill the water tank.	
P 17	Sliced carrots, fresh	0.10 - 0.75	Steaming tray + glass tray Position 3	Fill the water tank.	The thicker the slices, the firmer the result. If you would like it more well done, enter a higher weight into the automatic program. This extends the program duration.
P 18	Green asparagus, fresh	0.10 - 0.70	Steaming tray + glass tray Position 3	Fill the water tank.	Spread out flat

*Turn when the turn signal prompts you **Stir when the stir signal prompts you

Pro-gramme	Meal	Weight in kg	Cookware/accessories, shelf height	Information	Specific details
P 19	Eggs, soft-boiled	x 2 - 10	Steaming tray + glass tray Position 3	Fill the water tank.	Hen's eggs, chilled
P 20	Rice**	0.10 - 0.50	Deep cookware with lid Cooking compartment floor	Use microwave-safe cookware only.	Long-grain rice; do not use boil-in-the-bag rice. Add two-three parts water to one part rice. After the programme has ended, leave to stand for 5–10 minutes.
P 21	Baked potatoes	0.20 - 1.50	Wire rack Position 2		Medium-sized potatoes, approx. 250 g, wash, dry and pierce the skins several times with a fork.
P 22	Boiled potatoes	0.20 - 0.50	Steaming tray + glass tray Position 3	Fill the water tank.	Potatoes, peeled and diced. The larger the items, the firmer the result.
P 23	Fruit compote**	0.30 - 0.80	Shallow cookware on glass tray Position 3	Use microwave-safe cookware only. Fill the water tank.	Add some sugar and cinnamon to the fruit. For berry compotes, do not add raspberries and strawberries until you are prompted to stir the fruit.
Convenience					
P 24	Chips, frozen*	0.20 - 0.80	Glass tray Position 2		Spread out flat
P 25	Croquettes, frozen	0.25 - 0.80	Glass tray Position 2		Spread out flat
P 26	Pizza, pre-baked, chilled	0.10 - 0.60	Wire rack Position 2		Thin-crust pizza
P 27	Pizza, pre-baked, frozen	0.10 - 0.50	Wire rack Position 1		Thin-crust pizza, pizza baguette
P 28	Pasta bake, pre-cooked and chilled	0.30 - 1.00	Cookware on glass tray Position 2	Use microwave-safe cookware only.	Lasagne, cannelloni or pasta bakes using precooked pasta
P 29	Reheat plated meal, chilled	0.20 - 0.50	Shallow cookware on glass tray Position 3	Use microwave-safe cookware only. Fill the water tank.	
P 30	Reheat plated meal, frozen	0.20 - 0.50	Shallow cookware on glass tray Position 3	Use microwave-safe cookware only. Fill the water tank.	
*Turn when the turn signal prompts you **Stir when the stir signal prompts you					

Setting the time-setting options

Your appliance has various time-setting options. You can use the  touch field to call up the menu and switch between the individual functions. The symbols for the available functions light up in the display and the function that you just selected is highlighted.

Time-setting option	Use
 Timer	The timer functions like an egg timer. It runs independently of the appliance when it is heating and of other time-setting options and does not affect the appliance.
 Cooking time	Once the set cooking time has elapsed, the appliance automatically stops heating.
 Time	When no other function is running in the foreground, the appliance shows you the time of day in the display.





You can only call up the cooking time using the  field after setting a type of heating. The timer can be set at any time.

An audible signal sounds once the cooking time or timer duration has elapsed. You can cancel the signal early by touching the  field.

Note: You can change how long the audible signal sounds for in the basic settings. → "Basic settings" on page 28



Checking the time settings

If several time-setting options are set, the corresponding symbols light up in the display. The cooking time starts counting down.

To check the timer , cooking time  or time , touch  repeatedly until the relevant symbol is highlighted. During operation, only the timer and cooking time are available. In standby, only the timer and time are available. The value for this appears in the display for a few seconds.

Setting the timer

You can use the timer as a kitchen timer. It runs independently of the appliance. The timer has its own audible signal. In this way, you can tell whether it is the timer or a cooking time which has elapsed.

1. Touch the  field.
The  symbol and the time symbols light up again.
2. Use the rotary selector to set the timer duration. After a few seconds, the time setting is adopted. The timer starts. The  symbol lights up in the display and the timer counts down. The other time symbols go out.

The timer duration has elapsed

An audible signal sounds. -- : -- is shown in the display. Touch any field to switch off the timer.

Changing the timer duration

Use the rotary selector to change the timer duration. The change is applied after a few seconds.

Cancelling the timer duration

Use the rotary selector to reset the timer duration to -- : --. The change is applied after a few seconds. The timer is now switched off.

Setting a cooking time

You can set the cooking time for your food on the appliance. Once the cooking time has elapsed, the appliance will automatically switch itself off. The cooking time cannot be accidentally exceeded.

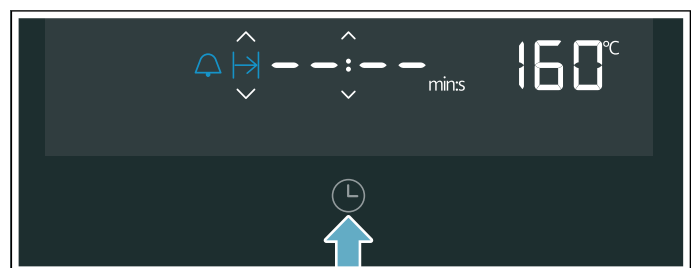

Example in the picture: Hot air heating function, cooking time of 45 minutes.

1. Use the function selector to set the heating function. A default value for the temperature is shown on the display.
2. Use the rotary selector to adjust the temperature if necessary.
3. Touch the  button twice.
-- : -- will be shown on the display and the time symbols will be lit.



4. Use the rotary selector to set a cooking time of 45 minutes.



5. Touch the  button.
The oven will start. The cooking time will count down on the display and the  LED will be lit. The other time symbols will go out.

The cooking time has elapsed

An audible signal sounds. The appliance stops heating. -- : -- is shown in the display.

1. Touch the  field.
The audible signal stops.
2. Turn the function selector to the off position. The appliance is switched off.

Changing the cooking time

Use the rotary selector to change the cooking time. After a few seconds, the change is applied.

Cancelling the cooking time

If the timer function has been set, first touch the  button. You will now be able to adjust the cooking time.

Use the rotary selector to reset the cooking time to -- : - -. After a few seconds, the change will be applied.

Initial use

After connecting the electricity supply or after a power cut, the display prompts you to set the time.



Setting the time

During initial use, the time display is highlighted. The *12:00* value flashes in the display and the  symbol lights up. Set the time.

1. Use the rotary selector to set the time.
2. Touch .
The time has now been set.

Changing the time on the clock

Note: To change the time on the clock, you will need to switch off the appliance.

1. Touch the  button twice.
The  symbol and the clock time will appear on the display.
2. Set the clock using the rotary selector.
3. Touch the  button.
The time has now been set.



Notes

- If you do not touch the  button after setting the time, the set value is automatically adopted after a few seconds.
- If the function selector has been moved to configure the settings, it must be returned to the "Off" position once you have finished. Only then can the appliance be used.
- In order to reduce the energy consumption of your appliance in standby, you can hide the clock.

Childproof lock

Your appliance is equipped with a childproof lock so that children cannot switch it on accidentally or change any settings.

Activating and deactivating

1. Turn the function selector to the off position.
2. Touch  for approx. 4 seconds.
The  symbol will appear on the display. The childproof lock is activated or deactivated.

Notes





- If a timer duration  has been set, this will continue to count down. While the childproof lock is active, the timer duration cannot be changed.
- Acoustic signals, e.g. once the timer duration has elapsed, can be ended by touching any field.

Basic settings

There are various settings available to you in order to help use your appliance effectively and simply. You can change these settings as required.

Changing the basic settings

The appliance must be switched off.

1. Touch the  button for a few seconds.
The first basic setting will appear on the display.
2. Use the rotary selector to change the basic setting.
3. Touch the  button.
The next basic setting will appear on the display. You can go through all of the basic settings using the  button and make changes using the rotary selector.
4. Touch the  button for a few seconds.
This applies all the settings.

If the appliance is in standby mode, you can change the settings at any time.

Cancelling

If you do not want to save the changes, turn the function selector. The basic settings are ended without being saved.

List of basic settings

	Basic setting	Options	Explanation
c01	Audible signal duration 1 = short = 10 seconds 2 = medium = 30 seconds	1 = short = 10 seconds 2 = medium = 30 seconds 3 = long = 2 minutes	Audible signal sounds after a set cooking time or duration elapses or when the timer reaches zero
c02	Button tone* 1 = On	0 = Off	Tone when touching touch fields
c03	Display brightness* 1 = low 2 = medium	1 = low 2 = medium 3 = high	Allows you to set the display brightness
c04	Time display 1 = On	0 = Off	Allows you to display the clock time
c05	Interior lighting 1 = On	0 = Off	Allows you to switch the interior lighting on or off
c06	Water hardness 1 = soft 2 = medium 3 = hard 4 = very hard	0 = softened 1 = soft 2 = medium 3 = hard	The water hardness affects the appliance's cleaning cycles
c07	Factory setting 0 = Off	1 = On	Allows you to reset appliance factory settings
c08	Demo mode 0 = Off	1 = On	Allows you to switch demo mode on and off Note: Demo mode is only visible in the first 5 minutes after connecting the appliance to the mains.

*The change is applied immediately.

Cleaning

With good care and cleaning, your appliance will retain its appearance and remain fully functioning for a long time to come. We will explain here how you should correctly care for and clean your appliance.

Warning – Risk of burns!

The appliance becomes very hot. Never touch the interior surfaces of the cooking compartment or the heating elements. Always allow the appliance to cool down. Keep children at a safe distance.

Warning – Risk of electric shock!

Do not use any high-pressure cleaners or steam cleaners, which can result in an electric shock.

Warning – Risk of injury!

Scratched glass in the appliance door may develop into a crack. Do not use a glass scraper, sharp or abrasive cleaning aids or detergents.

Note: Unpleasant odours, for example after fish has been prepared, can be removed very easily. Add a few drops of lemon juice to a cup of water. Always place a spoon in the container to prevent delayed boiling. Heat the water for 1 to 2 minutes at maximum microwave output.

Suitable cleaning agents

To ensure that the different surfaces are not damaged by using the wrong cleaning agent, observe the information in the table. Depending on the appliance model, not all of the areas listed may be on/in your appliance.

You can buy other accessories for your appliance from our customer service. Please specify the relevant product number.

New sponge cloths may contain salts. Salts can cause rust film on stainless steel, so cloths must always be washed out thoroughly before use.

Microfibre cloth

The microfibre cloth is especially suitable for cleaning easily damaged surfaces, such as glass, glass ceramic, stainless steel or aluminium. It removes liquid and greasy deposits in one go.

Order no. 00466148

Conditioning cloth for stainless steel surfaces

You can treat surfaces with a tested, recommended oil-impregnated conditioning cloth (available from us), which will make the surface more resistant to fingerprints and scratches.

Order no. 00311134

Conditioning oil for modern stainless steel surfaces

This is the same conditioning oil that is used in the cloths, and can be ordered from us in a bottle.

Order no. 00311567

Degreaser

For intensive removal of stubborn grease deposits from surfaces.

Order no. 00311781

Descaling agent

To ensure that your appliance continues to operate correctly, it must be descaled regularly. Only use a recommended descaling agent to do this. Other descaling agents may damage the appliance.

Liquid descaling agent: Order no. 00311680

Descaling tablets: Order no. 00311976

Caution!

Surface damage

Do not use any

- harsh or abrasive cleaning agents,
- cleaning agents with a high alcohol content,
- hard scouring pads or cleaning sponges,
- high-pressure cleaners or steam cleaners,
- special cleaners for cleaning the appliance while it is hot.

Area	Cleaning
Appliance exterior	
Stainless steel front	Hot soapy water: Clean with a dish cloth and then dry with a soft cloth. Remove flecks of limescale, grease, starch and albumin (e.g. egg white) immediately. Corrosion can form under such flecks. Special stainless steel cleaning products suitable for hot surfaces are available from our after-sales service or from specialist retailers. Apply a very thin layer of the cleaning product with a soft cloth.
Control panel	Hot soapy water: Clean with a dish cloth and then dry with a soft cloth. Do not use glass cleaner or a glass scraper.
Door panels	Hot soapy water: Clean with a dish cloth and then dry with a soft cloth. Do not use a glass scraper or a stainless steel scouring pad.
Door handle	Hot soapy water: Clean with a dish cloth and then dry with a soft cloth. If descaler comes into contact with the door handle, wipe it off immediately. Otherwise, any stains will not be able to be removed.
Appliance interior	
Self-cleaning surfaces	Observe the instructions for the surfaces of the cooking compartment that follow the table.
Inside of the door and door seal	Hot soapy water: Clean with a dishcloth. Do not remove the door seal. Do not scour. Check the position of the door seal after cleaning it.

Stainless-steel surfaces	Hot soapy water: Clean with a dishcloth. Do not scour. Check the position of the door seal after cleaning it.
Accessories	Hot soapy water: Soak and clean with a dish cloth or brush.
Waste water tank and water tank	Hot soapy water: Clean with a dish cloth and rinse thoroughly with clean water to remove residual detergent. Dry with a soft cloth. Leave to dry with the lid open. Rub the seal on the lid until dry. Do not clean in the dishwasher.
Tank recess	Rub dry after every use.
Steam outlet in cooking compartment	Hot, soapy water: Use a cleaning sponge or a soft washing-up brush.

Notes

- Slight differences in colour on the front of the appliance are caused by the use of different materials, such as glass, plastic and metal.
- Shadows on the door panels, which look like streaks, are caused by reflections made by the interior lighting.

Cleaning self-cleaning surfaces

The rear panel of the cooking compartment has a self-cleaning, catalytic coating. This coating absorbs and dispels splashes from baking and roasting while the appliance is in operation. It is therefore not necessary to clean this area.

Caution!

Do not use oven cleaner on the self-cleaning surfaces. This damages the surfaces. If oven cleaner does get onto these surfaces, dab it off immediately using water and a sponge cloth. Do not rub the surface and do not use abrasive cleaning aids.

When the cooking compartment has cooled down, remove the brown or white residue with water and a soft sponge.

Note: During operation, reddish spots form on the surfaces. This is not rust, but residue from food. These spots are not harmful and do not restrict the cleaning ability of the self-cleaning surfaces.

Keeping the appliance clean

Always keep the appliance clean and remove dirt immediately so that stubborn deposits of dirt do not build up.

Tips

- Clean the cooking compartment after each use. This ensures that dirt cannot be baked on.
- Always remove flecks of limescale, grease, starch and albumin (e.g. egg white) immediately.
- Use the glass tray for baking very moist cakes.
- Use suitable ovenware for roasting, e.g. a roasting dish.
- Where possible, use hot air. This type of heating creates less dirt.

Cleaning function

Descaling

To ensure that your appliance continues to operate correctly, it must be descaled regularly.

Caution!

- Risk of damage to the appliance: Only use the descaler recommended by us for descaling, either in liquid or tablet form. The time the descaler needs to be left to work depends on the product used. Other descalers may damage the appliance. You can order descaler from our after-sales service.
Liquid descaler: Order no. 00311680
Descaling tablets: Order no. 00311976
- Descaling solution: Do not allow any descaling solution or descaler to come into contact with the control panel or other surfaces on the appliance. This may damage the surfaces. If this does happen, remove the descaling solution immediately with water.

Descaling consists of two automated steps. For hygiene reasons, the descaling program must be run through completely before the appliance is ready for operation again. Descaling will take around 32 minutes in total.

- Descale the appliance (approx. 31 minutes), then empty the drip tray and fill the water tank with fresh water.
- Run a rinse cycle after descaling the appliance (approx. 1 minute), then empty the drip tray.

If descaling is interrupted (e.g. due to a power failure, because the appliance is switched off or because the descaling process is cancelled), you will be prompted to run a rinse cycle once the appliance is switched back on. The appliance cannot be used until the rinse cycle comes to an end.

The frequency with which the appliance must be descaled depends on the hardness of the water used. When only five more steam-assisted operations are possible (or fewer), the  symbol appears on the appliance display, reminding you to descale it. You can therefore prepare for the descaling in good time.

The steam mode is then only possible after the descaling process has been completed.

Starting

1. Use the function selector to select Descale .
The duration of the descaling process will be displayed. It cannot be changed.
2. Open the tank cover.
3. Remove and empty the drip tray.
4. Slide the empty drip tray in fully.
5. Remove the water tank.
6. Mix water and descaler to create a descaling solution.

Note: Observe the mixing ratio of the descaling agent.

Descaling liquid (Order no. 00311680): Mixing ratio 1:5, mix 50ml descaling liquid with 250ml water.
Descaling tablets (Order no. 00311976): Add one descaling tablet (18g) to 250ml water and let dissolve for five minutes.

7. Pour the descaling solution into the water tank and slide the water tank in fully.
8. Close the tank cover.
9. Touch the ▷/□ button.
The appliance will now be descaled. The remaining time counts down on the display. An audible signal will sound once descaling has finished. The appliance pauses.
10. Open the tank cover.
11. Remove the drip tray, empty it and slide it back in.
12. Remove the water tank, rinse it thoroughly, fill it with fresh water and slide it back in.
13. Close the tank cover.
14. Touch the ▷/□ button.
The appliance will now be rinsed twice automatically. An audible signal will sound once the rinse cycles have finished. Empty the drip tray.

Rinsing

To ensure that your appliance stays clean, you can pump water through the pipe system. The water is then drained to the waste water tank.

Note: After rinsing, there can be dissolved lime particles in the waste water tank. This is normal and does not affect operation.

Starting

1. Use the function selector to select the rinse cycle . The duration of the programme will be displayed. It cannot be changed.
2. Open the tank cover.
3. Remove and empty the waste water tank.
4. Slide the empty waste water tank in fully.
5. Remove water tank and drain any residual water. Rinse out water tank thoroughly and fill with fresh water.
6. Slide the water tank in fully.
7. Close the tank cover.
8. Touch the ▷/□ button.
Water is pumped through the pipes. The time remaining will count down on the display. An audible signal will sound once this time has elapsed. Empty the waste water tank.

Subsequent cleaning

Carry out the following steps after every descaling programme or rinse cycle:

1. Open the tank cover.
2. Empty, clean and dry the waste water tank and water tank.
3. Turn the function selector to the off position.
The process is complete and the appliance is ready for use again.

Emptying the waste water tank

With the cleaning functions, the residual water is collected in the waste water tank. Then empty and dry the waste water tank.

Caution!

- Do not dry the waste water tank in the hot cooking compartment. This will damage the waste water tank.
- Do not clean the waste water tank in the dishwasher. This will damage the waste water tank.

1. Briefly press on the centre of the tank cover. The tank cover opens. The waste water tank and water tank can now be accessed.
2. Remove the waste water tank from the tank recess.

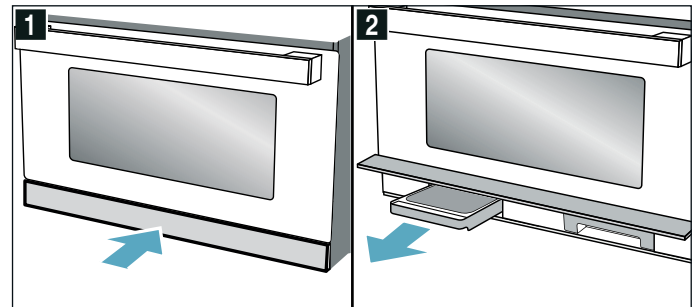

3. Open the lid for the waste water tank.
4. Empty the waste water tank.

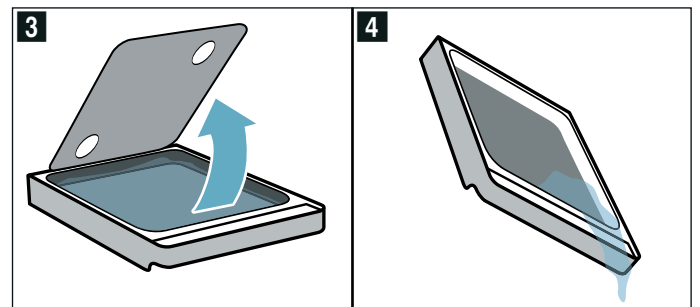

5. Insert the waste water tank back into the tank recess and slide it in fully.
6. Close the tank cover.

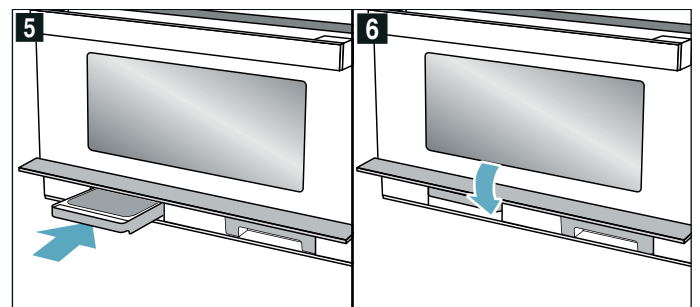

The appliance is ready to use.

Trouble shooting







If a fault occurs, there is often a simple explanation. Before calling the after-sales service, please refer to the fault table and attempt to correct the fault yourself.

Warning – Risk of electric shock!

Incorrect repairs are dangerous. Repairs may only be carried out and damaged power cables replaced by one of our trained after-sales technicians. If the appliance is defective, unplug the appliance from the mains or switch off the circuit breaker in the fuse box. Contact the after-sales service.

You can take remedial action yourself for some error messages.

Troubleshooting

Error message	Possible cause	Remedy/Note
The appliance does not work	The plug is not plugged into the mains	Plug the plug in
	Power failure	Check whether the kitchen light works
	The fuse is faulty	Check in the fuse box to make sure that the fuse for the appliance is OK
	Faulty operation	Switch off the fuse in the fuse box. Switch it back on after approx. 10 seconds
Although the appliance is switched on, it cannot be operated; the  symbol is in the display	The childproof lock is activated	Press and hold  until the  symbol goes out
The interior lighting has failed.	The LED bulb is defective	Call our customer service
 12:00 flashes in the display and the  symbol lights up.	Power failure	Reset the clock
The appliance is not operating. A cooking time is shown in the display.	 /□ was not touched after the setting was made.	Touch  /□ or delete the setting by using the function selector to select another function.
The microwave is not working.	The door has not been properly closed.	Check whether food residue or debris is trapped in the door
	 /□ was not touched.	Touch  /□
It is taking longer than usual for food to heat up	The microwave power output has been set too low.	Select a higher microwave power output
	A larger amount of food than usual has been placed in the appliance.	Double the amount – double the time
	The food was colder than usual.	Stir or turn the food during cooking
Microwave operation has been cancelled for no apparent reason.	The microwave has a fault.	If this fault recurs, call our customer service.
The appliance can be set, but does not heat up. The colon flashes.	The appliance is in demo mode.	Deactivate demo mode in the basic settings. Note: Demo mode is only visible in the first 5 minutes after connecting the appliance to the mains.
The water tank and drip tray symbols are flashing continuously.	Technical problem.	Make sure that the water tank and drip tray are fully inserted in the relevant tank recess. If the symbols continue to flash, call our customer service. You may continue to use the appliance, except for the steam function.
The warm air / steam escapes above the appliance door.	The cooling fan is running	No malfunction. The cooling fan continues running for a short time after operation ends. The cooling fan protects the appliance from overheating.
The cooling fan continues to run after operation ends.	The appliance needs to be cooled after operation.	No malfunction.
The cooling fan continues to run when the appliance door is opened.	The appliance needs to be cooled during and after operation.	No malfunction. All cooking functions (microwave, etc.) are stopped when the door is opened.
Steam is not visible in the hot air / grill combination mode.	Steam is not visible in every temperature range. The hotter the steam, the less visible it is.	No malfunction.

Error message	Possible cause	Remedy/Note
Collecting tank is empty after operation.	In steam / steam combination mode, the condensation is collected by the glass plate on the cooking compartment floor and the grey drip tray in the bottom plate. The condensation does not reach the collecting tank.	The collecting tank serves only the rinsing and descaling process, not the normal steam / steam combination mode. See also chapter "Steam".
White lime scale particles are in the collecting tank.	During rinsing or descaling, fine particles of lime dissolve out of the boiler.	During rinsing and descaling, stuck lime particles may come loose. Check the water hardness setting. Perform the descaling process at the recommended intervals.
Low water consumption in combination mode. Especially in combination mode with 3 functions.	In steam combination mode, especially with 3 functions, it may be that only small amounts of steam are used. Therefore, only little water is consumed from the fresh water tank.	No malfunction.
<i>E0532.</i>	Dirt on the control panel is creating a touch field that is permanently active.	Switch off the appliance and clean the control panel. Switch the appliance on again. If this fault recurs immediately after switching back on, call our customer service.
<i>E5005.</i>	The steam function has been activated multiple times with an empty water tank.	Before next use, make sure that the water tank is filled with cold water and fully inserted in the tank recess. If this fault recurs, call our customer service.

Customer service

Our after-sales service is there for you if your appliance needs to be repaired. We will always find an appropriate solution, also in order to avoid after-sales personnel having to make unnecessary visits.

E number and FD number

When calling us, please give the product number (E no.) and the production number (FD no.) so that we can provide you with the correct advice. The rating plate bearing these numbers can be found on the right-hand side when you open the appliance door. To save time, you can make a note of the number of your appliance and the telephone number of the after-sales service in the space below, should it be required.

E no.	FD no.
-------	--------

After-sales service

Please note that there will be a fee for a visit by a service technician in the event of a malfunction, even during the warranty period.

Please find the contact data of all countries in the enclosed customer service list.

To book an engineer visit and product advice

GB	0344 892 8999 Calls charged at local or mobile rate.
IE	01450 2655 0.03 € per minute at peak. Off peak 0.0088 € per minute.

Rely on the professionalism of the manufacturer. You can therefore be sure that the repair is carried out by trained service technicians who carry original spare parts for your appliances.

This appliance corresponds to the standards EN 55011 and CISPR 11. It is a Group 2, Class B product.

Group 2 means that microwaves are produced for the purpose of heating food. Class B states that the appliance is suitable for private households.

Tested for you in our cooking studio

Here, you can find a selection of dishes and the ideal settings for them. We will show you which type of heating and temperature are best suited to your dish. You will get information on suitable cooking accessories and the height at which they should be placed in the oven. You will also get tips about cookware and preparation methods.

Note: A lot of steam can build up in the cooking compartment when cooking food.

Your appliance is very energy-efficient and radiates very little heat to its surroundings during operation. Due to the high difference in temperature between the appliance interior and the external parts of the appliance, condensation may build up on the door, control panel or adjacent kitchen cabinet panels. This is a normal physical phenomenon. Condensation can be reduced by preheating the oven or opening the door carefully.

When steaming or during operation with steam assistance, it is desirable that there is a significant build-up of steam in the cooking compartment. Wipe the cooking compartment clean after cooking, once it has cooled off.

General information

Recommended setting values

The table lists the optimum function for various types of food. The temperature/settings and duration depend on the cookware used and the quantity, quality, temperature and consistency of the food. Settings ranges are indicated for this reason. Try using the lower values to start with. You can use a higher setting next time if necessary.

When using the microwave, always set the longest specified time but check your meal after the shortest specified time.

Before cooking with steam, ensure that the water tank is full.

It may be that you have different quantities from those specified in the tables. There is a rule of thumb for operating the microwave on its own: Double the amount = almost double the time, half the amount = half the time.

The setting values apply to food that is placed into a cold cooking compartment.

Preheating is necessary for selected food, and this is indicated in the table. Do not place your food and accessory into the cooking compartment until it has finished preheating.

Some dishes turn out best if they are cooked in multiple stages. These are indicated in the table.

If you wish to follow one of your own recipes, you should use the settings listed in the table for similar food as reference. Additional information can be found in the baking tips listed after the settings tables.

Remove any accessories that are not being used from the cooking compartment.

Accessories

Only use genuine accessories for your appliance. These have been tailored to the cooking compartment and the operating modes of your appliance.

Ensure that you always use suitable cookware and accessories, and that they are placed in the oven the right way around.

Also observe the notes on using cookware suitable for microwave cooking and cooking with steam in the relevant sections. → "Microwave" on page 16 → "Steam" on page 19

Always use an oven cloth or oven gloves when taking hot accessories or cookware out of the cooking compartment.

Bakeware and cookware

For best results, we recommend using dark-coloured metal bakeware.

Tinplate baking tins, ceramic dishes and glass dishes extend the baking time and prevent the bake from browning evenly.

If you would like to use silicone moulds, check the manufacturer's instructions to see whether they are suitable for use with microwaves or steam-assisted cooking. Use the manufacturer's instructions and recipes as a guide.

Silicone moulds are often smaller than normal baking tins. The given quantities and recipes may vary.

As a general rule:

- Bake on the glass tray with hot air, shelf position 2
- Bake in a tin on the wire rack with hot air, shelf position 1
- Roasts on the wire rack or the glass tray, shelf position 2. If you use the wire rack, place the glass tray underneath.
- Grill on the wire rack on shelf position 3 or 4. Place the glass tray underneath.

- Microwave-only operation: Cookware on the bottom of the cooking compartment, shelf position 0.
- Steam-only operation: Glass tray with steamer basket on shelf position 3.

Greaseproof paper

Only use greaseproof paper that is suitable for the selected temperature. Always cut greaseproof paper to size.

Do not line accessories with greaseproof paper until after they have been preheated.

Defrosting

Place the frozen food in an uncovered container on the bottom of the cooking compartment.

Delicate parts such as the drumsticks and wings of chicken or fatty outer layers of roasts can be covered with small pieces of aluminium foil. The foil must not touch the walls of the appliance. You can remove the foil half way through the defrosting time.

Liquid will be produced when defrosting meat or poultry. Drain off this liquid when turning meat and poultry and under no circumstances use it for other purposes or allow it to come into contact with other foods.



Turn or stir the food once or twice during the process. Large pieces of food should be turned several times.













Leave defrosted items to stand at room temperature for a further 10 to 60 minutes so that the temperature can stabilise. You can remove the giblets from poultry at this point.

The meat can also be processed further when a small part of the core is frozen.

Notes

- Use an uncovered item of cookware and place it on the bottom of the cooking compartment.
- Please note that a setting can comprise several steps.
- Always set the maximum specified time but check your meal after the minimum specified time.

Dish	Cookware	Shelf position	Heating function	Weight	Steps	Microwave setting	Cooking time in min	Notes
Whole pieces of beef, pork or veal (on the bone or boned)	Cookware, uncovered	0		800 g	1	180	15	Turn frequently.
					2	90	15 - 25	
				1000 g	1	180	15	
					2	90	25 - 35	
				1500 g	1	180	20	
					2	90	25 - 35	
Meat in pieces or slices of beef, veal or pork	Cookware, uncovered	0		200 g	1	180	5	Turn during cooking. Separate any defrosted parts.
					2	90	4 - 6	
				500 g	1	180	10	
					2	90	5 - 10	
				800 g	1	180	10	
					2	90	10 - 15	

Dish	Cookware	Shelf position	Heating function	Weight	Steps	Microwave setting	Cooking time in min	Notes
Minced meat, mixed	Cookware, uncovered	0		200 g	1	90	15	Freeze food flat if possible. Turn frequently during defrosting and remove any minced meat that has already defrosted.
				500 g	1	180	5	
					2	90	10 - 15	
				800 g	1	180	10	
2	90	15 - 20						
Poultry or poultry pieces	Cookware, uncovered	0		600 g	1	180	5	Turn during cooking.
					2	90	10 - 15	
				1200 g	1	180	10	
					2	90	20 - 25	
Duck	Cookware, uncovered	0		2000 g	1	180	20	Turn several times.
					2	90	30 - 40	
Goose	Cookware, uncovered	0		4500 g	1	180	30	Turn every 20 minutes. Remove any liquid that results from defrosting.
					2	90	60 - 80	
Fish fillet, fish steak or slices	Cookware, uncovered	0		400 g	1	180	5	Turn during cooking. Separate any defrosted parts.
					2	90	10 - 15	
Whole fish	Cookware, uncovered	0		300 g	1	180	3	Turn several times.
					2	90	10 - 15	
				600 g	1	180	8	
					2	90	15 - 25	
Vegetables, e.g. peas	Cookware, uncovered	0		300 g	1	180	10 - 15	Stir during cooking.
					2	90	9 - 15	
				600 g	1	180	10	
Fruit, e.g. raspberries	Cookware, uncovered	0		300 g	1	180	7 - 10	Stir several times. Separate any defrosted parts.
					2	90	5 - 10	
				500 g	1	180	8	
Butter, defrosting	Cookware, uncovered	0		125 g	1	90	6 - 8	Remove all packaging.
					2	90	3 - 5	
				250 g	1	180	2	
Bread, loaf	Cookware, uncovered	0		500 g	1	180	3	Turn during cooking.
					2	90	10 - 15	
				1000 g	1	180	5	
					2	90	15 - 25	
Cakes, plain, e.g. sponge cake	Cookware, uncovered	0		500 g	1	90	10 - 15	Only for cakes without icing, whipped cream or crème pâtissière, separate the pieces of cake.
					2	90	10 - 15	
				750 g	1	180	3	
Cakes, moist, e.g. fruit flan, cheesecake	Cookware, uncovered	0		500 g	1	180	5	Only for cakes without icing, whipped cream or gelatine.
					2	90	15 - 25	
				750 g	1	180	7	
					2	90	15 - 25	

Heating frozen food

Take ready meals out of the packaging. They will heat up more quickly and evenly in microwaveable cookware. The speed at which different components of the meal heat up may vary.

Food which lies flat will cook more quickly than food which is piled high. You should therefore distribute the food so that it is as flat as possible in the cookware. Food should not be placed in layers on top of one another.









Stir or turn the food 2 or 3 times during the process.

After heating, leave the food to stand for a further 2 to 5 minutes to allow the temperature to stabilise.

Always wear oven gloves or use a pot holder when removing cookware from the appliance.

Notes

- Place the cookware on the bottom of the cooking compartment.
- Always cover the food. If you do not have a dedicated lid for your cookware, use a plate or special microwave film.
- Always set the maximum specified time but check your meal after the minimum specified time.

Dish	Cookware	Shelf position	Heating function	Weight	Microwave setting	Cooking time in min	Notes
Soup, frozen	Cookware, covered	0		400 g	600	8 - 15	
Stew, frozen	Cookware, covered	0		500 g	600	8 - 13	
				1000 g	600	20 - 25	
Menu, plated meal, ready meal (2-3 components), frozen	Cookware, covered	0		300 - 400 g	600	11 - 15	
Slices or pieces of meat in sauce, e.g. goulash, frozen	Cookware, covered	0		500 g	600	12 - 17	Separate the pieces of meat when stirring.
				1000 g	600	25 - 30	
Bakes, e.g. lasagne, cannelloni, frozen	Cookware, covered	0		450 g	600	10 - 15	
Side dishes, e.g. rice, pasta, frozen	Cookware, covered	0		250 g	600	2 - 5	Add liquid
				500 g	600	8 - 10	
Vegetables, e.g. peas, broccoli, carrots, frozen	Cookware, covered	0		300 g	600	8 - 10	Add enough water to cover the base
				600 g	600	14 - 17	
Creamed spinach, frozen	Cookware, covered	0		500 g	600	11 - 16	Cook without adding water, stir occasionally

Warming

Warning Risk of scalding!

- There is a possibility of delayed boiling when a liquid is heated. This means that the liquid reaches boiling temperature without the usual steam bubbles rising to the surface. Even if the container only vibrates a little, the hot liquid may suddenly boil over and spatter. When heating, always place a spoon in the container. This will prevent delayed boiling.

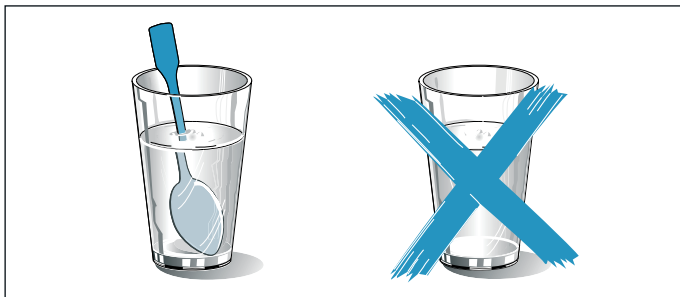

Caution!

Metal, e.g. a spoon in a glass, must be kept at least 2 cm from the oven walls and the inside of the door. Sparks could irreparably damage the glass on the inside of the door.

Notes

- Take ready meals out of the packaging. They will heat up more quickly and evenly in microwaveable cookware. The speed at which different components of the meal heat up may vary.
- Stir or turn the food frequently during the process. Check the temperature.
- After heating, leave the food to stand for a further 2 to 5 minutes to allow the temperature to stabilise.
- Always wear oven gloves or use a pot holder when removing cookware from the appliance.
- Cover the food if this is specified in the table. Place the cookware on the bottom of the cooking compartment. If you would like to activate the steam function, place your cookware on the glass tray in shelf position 3. Fill the water tank.

Dish	Cookware	Shelf position	Heating function	Weight/quantity	Microwave setting	Steam setting	Cooking time in min	Notes
Baby food, e.g. baby bottles	Cookware, uncovered	0		150 ml	360	-	0.5-1.5	No teats or lids. Always shake well after heating. Always check the temperature.
Beverages	Cookware, uncovered	0		200 ml	1000	-	1-2	Place a spoon in the glass; do not overheat alcoholic drinks; check occasionally
				500 ml	1000	-	4-5	
Soup, 2 cups, 175 g each	Cookware, uncovered	0		350 g	600	-	3-4	
Soup, 4 cups, 175 g each	Cookware, uncovered	0		700 g	600	-	6-8	
Meat or pieces of meat in sauce	Cookware, covered	0		500 g	600	-	7-10	Separate the slices of meat
Menu, plated meal, ready meal (2-3 components)	Cookware, uncovered	3	+	400 g	360	3	9-14	
Stew	Cookware, covered	0		400 g	600	-	6-8	
				800 g	600	-	8-11	
Vegetables	Cookware, uncovered	3	+	150 g	360	3	3-5	
	Cookware, uncovered	3	+	300 g	360	3	4-7	

Microwave tips

You cannot find any information about the settings for the quantity of food you have prepared.	Lengthen or shorten the cooking time according to the following rule of thumb: Double the amount = double the time, half the amount = half the time
The food has become too dry.	Next time set a shorter cooking time or select a lower microwave power setting. Cover the food and add more liquid.
The time has elapsed but the food is not defrosted, not hot or not cooked.	Set a longer time. Large quantities and food which is piled high require longer times.
Time has elapsed and the food is overheated at the edge but not done in the middle.	Stir it occasionally and next time select a lower microwave power setting and a longer cooking time.
After defrosting, the poultry or meat is cooked on the outside but not defrosted in the middle.	Next time select a lower microwave power setting. If you are defrosting a large quantity of food, turn it frequently.

Cakes, small baked items and bread

The settings tables list the optimum settings for many bakes.

To prove dough, place the dough in a bowl and cover it with film or a tea towel. Place this on the bottom of the cooking compartment and then set 40 °C hot air.

Baking in combination with a microwave

Baking in combination with a microwave considerably reduces the cooking time.

Always use heat-resistant cookware that is suitable for microwave use. Observe the notes on cookware suitable for microwaves. → "Microwave" on page 16

In combined operation, you can use conventional metal baking tins. If sparks are produced between the baking tin and the wire rack, check whether the tin is clean on the outside. Change the position of the tin on the wire rack. If this does not help, continue baking without the microwave. The baking time will be longer. If you use baking tins made of plastic, ceramic or glass, the

baking time indicated in the settings tables will be shorter.

Steam-assisted baking

Using steam-assisted baking gives certain baked items (e.g. yeast-risen pastries) a crispier crust and glossier surface. The baked item does not dry out as much.

Fill the water tank up to the "max." mark. If the appliance runs out of water, it will continue to cook your meal with the selected heating function but without adding steam.

Frozen products

Carefully take the food out of the packaging. Do not use frozen products that are covered with a thick layer of ice. Remove any ice on the food.

Some frozen products may be unevenly pre-baked. Uneven browning may remain even after baking.

Bread and rolls

Never pour water into the hot cooking compartment or place cookware containing water onto the bottom of the cooking compartment. The change in temperature could damage the bottom of the cooking compartment.

Switch on the steam function for hot air. The settings for bread dough apply to both dough placed on a baking tray and dough placed in a loaf tin.

Cakes in tins

Dish	Cookware	Shelf position	Heating function	Temperature in °C	Microwave setting	Cooking time in min
Sponge cake, simple*	Ring-shaped cake tin/ Vienna ring tin/loaf tin	1		160-170	-	60-80
Sponge cake, delicate (e.g. sand cake)*	Ring-shaped cake tin/ Vienna ring tin/loaf tin	1		150-160	-	60-70
Nut cake	Springform tin, Ø 26 cm	1		170-180	90	30-35
Sponge flan base	Flan tin	1		160-170	-	35-45
3-egg fatless sponge cake	Springform tin, Ø 26 cm	1		160-170	-	40-50
Fruit tart or cheesecake with shortcrust pastry*	Springform tin, Ø 26 cm	2		150-160	360	40-50
Fruit cake, delicate, made of sponge	Ring-shaped cake tin/ springform tin	1		170-190	90	30-45
Savoury bakes (e.g. quiche/ onion tart)	Springform tin	2		160-180	90	50-70

*Allow cakes to cool in the oven for approx. 20 minutes

Cakes on baking trays

Dish	Cookware	Shelf position	Heating function	Temperature in °C	Microwave setting	Steam setting	Cooking time in min
Sponge cake with dry topping	Glass tray	2		160-170	-	-	30-40
Yeast cake with moist topping, e.g. yeast dough with apple crumble*	Glass tray	1		160-170	-	-	30-45
Plaited loaf with 500 g flour*	Glass tray	1		170-180	-	3	35-45
Strudel filled with fruit, pre-baked, frozen	Glass tray	1		180-200	-	2	40-50
Pizza	Glass tray	2		210-230	-	-	25-35
Pizza, pre-baked, frozen	Wire rack	2		180-190	180	-	8-15
Pizza baguette, pre-baked, frozen	Wire rack	2		190-210	180	-	12-15

*Preheat

Small baked products and biscuits

Meal	Cookware	Shelf position	Heating function	Temperature in °C	Duration in min.
Biscuits	Glass tray	2		150-170	20-35
Meringue	Glass tray	2		100	90-120
Macaroons	Glass tray	2		110	35-45
Puff pastry	Glass tray	2		170-180	35-45

Bread and rolls

Meal	Cookware	Shelf position	Heating function	Steps	Temperature in °C	Grill setting	Steam level	Duration in min.	Notes
Bread, 1 kg*	Glass tray	1	+	1	230	-	3	10-15	Never pour hot water directly into a hot oven.
				2	190-200	-	-	30-45	
Bread 1.5 kg*	Cake tin	0	+	1	230	-	3	10-15	
				2	200-210	-	-	40-50	
Bread rolls, e.g. wheat rolls*	Glass tray	1	+	1	200-220	-	3	25-35	
Bread for toasting, 12 slices	Wire rack	3		1	-	3	-	3-6	
Bread for toasting, 4 slices	Wire rack	3		1	-	3	-	3-6	Place the slices of bread next to each other in the centre of the wire rack.
Toast with topping, 2-4 slices	Wire rack + glass tray	3+1		1	-	3	-	8-10	

*preheat

Baking tips

Sparks are generated between the tin and the wire rack.	Check that the tin is clean on the outside. Change the position of the tin in the oven. If this does not help, continue baking without microwaves or place the tin on the glass tray. The baking time will then be longer.
You want to find out whether the baked item is completely cooked in the middle.	Push a cocktail stick into the highest part of the baked item. If the cocktail stick comes out clean with no dough residue, the baked item is ready.
The baked item collapses.	Next time use less liquid. Alternatively, set the temperature to be 10 °C lower and extend the baking time. Use the ingredients and preparation instructions given in the recipe.
The baked item has risen in the middle but is lower around the edges.	Only grease the base of the springform cake tin. After baking, loosen the baked item carefully with a knife.
Small baked items stick to one another during baking.	There should be a gap of approx. 2 cm around each item. This gives enough space for the baked items to expand well and brown on all sides.
The baked item is too dry.	Set the temperature 10 °C higher and shorten the baking time.
The baked item is too light in colour overall.	If the shelf position and the cookware are correct, then you should increase the temperature if necessary or extend the baking time.
The back of an item baked in a tin or loaf tin is too dark.	Place the baking tray in the middle of the accessory, not directly against the back wall of the oven.
The baked item is too dark in colour overall.	Select a lower temperature next time and extend the baking time if necessary.
The cake is unevenly browned.	Select a slightly lower temperature. Protruding greaseproof paper can affect the air circulation. Always cut greaseproof paper to size. Ensure that the baking tin does not stand directly in front of the openings in the cooking compartment back wall. When baking small items, you should use similar sizes and thicknesses wherever possible.
The baked item looks good but it is not cooked properly in the middle.	Bake for longer at a lower temperature and add less liquid if necessary. For baked items with a moist topping, bake the base first. Sprinkle it with almonds or breadcrumbs and then place the topping on top.
The baked item will not come out of the tin when turned upside down.	Allow the baked item to cool down for 5 to 10 minutes after baking. If it still sticks, carefully loosen the cake around the edges again using a knife. Turn the baked item upside down again and cover the tin several times with a cold, wet cloth. Next time grease the tin and sprinkle with breadcrumbs.

Bakes and gratins



You can use your appliance to cook bakes and gratins. The settings tables list the optimum settings for certain meals.

How well cooked a bake is will depend on the size of the cookware and the depth of the bake. Use wide, shallow cookware for bakes and gratins. Food takes

longer to cook in deep, narrow cookware and it browns more on top. Always use the indicated shelf positions.

Observe the notes on cookware suitable for microwaves. → *"Microwave" on page 16*

Use a shallow ovenproof dish that is 4-5 cm deep. Bakes and gratins should be left to cook in the oven for a further 5 minutes after the oven has been switched off.

Dish	Cookware	Shelf position	Heating function	Temperature	Microwave setting	Cooking time in min
Bakes, sweet, e.g. quark and fruit soufflé, 1.5 kg	Ovenproof dish	0		130-150	180	25-35
Savoury bakes made from cooked ingredients, e.g. pasta bake, 1 kg	Ovenproof dish	0		180-190	600	12-17
Savoury bakes made from raw ingredients, e.g. potato gratin, 1.1 kg	Ovenproof dish	0		170-180	600	20-30

Poultry, meat and fish

Your appliance offers different methods of cooking poultry, meat and fish. The settings tables list the optimum settings for numerous meals. Some dishes turn out best if they are cooked in multiple stages. These are indicated in the table.

Cooking with cookware

⚠ Warning – Risk of injury from shattering glass!
Place hot glass cookware on a dry mat after cooking. The glass may crack if placed on a cold or wet surface.

Only use cookware that is suitable for what you intend to use it for. Glass cookware is best. Check whether the cookware fits in the cooking compartment.

Stainless steel and aluminium roasting trays that have a shiny surface are not suitable for microwave use. During conventional cooking, shiny roasting trays reflect heat like a mirror, meaning that they are not entirely suitable. The poultry, meat and fish cooks slower and does not brown so well. Use a higher temperature and/or a longer cooking time for conventional cooking.

Observe the manufacturer's instructions for your roasting trays.

Uncovered cookware

To cook poultry, meat and fish, it is best to use a deep roasting tin. Place the tin on the bottom of the cooking compartment. If you would like to use steam-assisted cooking, use an uncovered item of cookware. If you do not have any suitable cookware, use the glass tray.

Covered cookware

Ensure that the lid fits well and closes properly. Place the cookware onto the wire rack.

⚠ Warning – Risk of scalding!

Very hot steam may escape when opening the lid after cooking. Lift the lid at the rear so that the hot steam can escape away from you.

Cooking in combination with a microwave

This considerably reduces the cooking time. Unlike in conventional operation, when roasting in combination with a microwave the cooking time is based on the total weight.

Note: If you have different quantities to those indicated in the settings tables, the following basic rule applies: double the quantity equates to roughly double the cooking time. Always use heat-resistant cookware that is suitable for microwave use. Metal roasting dishes or earthenware pots are only suitable for roasting without using the microwave. Observe the notes on cookware suitable for microwaves. → *"Microwave" on page 16*

Steam-assisted cooking

Certain foodstuffs will become crispier during steam-assisted cooking. Their surface becomes glossier and they dry out less.

Use cookware without a lid. Cookware must be heat- and steam-resistant. Use steam-assisted cooking if it is indicated in the settings table. Fill the water tank up to "max." mark. If the appliance runs out of water, it will continue to cook your meal with the selected heating function but without adding steam.

Steaming using the steaming tray

In contrast to steam-assisted cooking, the steaming function cooks the meat particularly gently but it does not become crispy on the outside. It remains very succulent.

You can also sear pieces of meat before steaming, which will reduce their cooking time and give them a slightly different flavour. Larger pieces require a longer cooking time. Pieces of meat do not need to be turned.

To steam poultry, meat or fish, place the item to be cooked in the steaming tray in the glass tray and then place this in the cooking compartment at shelf position 3. Fill the water tank up to "max." mark. If the water tank runs out of water while the appliance is in operation, the appliance is paused. You will be alerted to this by a message on the display.

Grilling

Keep the appliance door closed when using the grill. Never grill with the appliance door open.

Place the food to be grilled on the wire rack. Place the glass tray underneath the wire rack to collect any dripping fat.

Try to use pieces of food of a similar thickness and weight. This will allow them to brown evenly and remain succulent and juicy. Place the food to be grilled directly onto the wire rack.

Use tongs to turn the pieces of food you are grilling. If you pierce the meat with a fork, the juices will run out and it will become dry.

Do not add salt to the meat until it has been grilled. Salt draws water from the meat.

Notes

- The grill elements continuously switch on and off; this is normal. The grill setting determines how frequently this occurs.
- Smoke may be produced when grilling.

Recommended settings

The settings are based on the assumption that unstuffed, chilled, ready-to-roast poultry, meat or fish is placed into a cold cooking compartment.

The table lists specifications for poultry, meat and fish with default values for the weight. If you wish to prepare heavier poultry, meat or fish, always use the lower temperature. If cooking more than one piece, use the weight of the heaviest piece as a basis for determining the cooking time. The individual pieces should be approximately the same size.

The larger the poultry, meat or fish, the lower the cooking temperature and the longer the cooking time.







Turn poultry, meat and fish if specified in the settings table.

Poultry

When cooking duck or goose, pierce the skin on the underside of the wings. This allows the fat to run out.

If using duck breast, score the skin. Do not turn duck breasts.

Poultry

Dish	Cookware	Shelf position	Heating function	Temperature	Grill setting	Microwave setting	Steam setting	Cooking time in min	Notes
Chicken, whole, 1.3 kg (boil)	Cookware, covered	0		-	-	600	-	25-35	Turn halfway through.
Chicken, whole, 1.3 kg (roast)	Cookware, uncovered	0	 +  + 	190	-	360	3	40-45	Place with the breast side up. Do not turn. Leave to stand for 5 minutes.
Chicken portions, e.g. chicken quarters, 800 g	Cookware, uncovered	0	 + 	190	-	180	-	20-35	Pierce the skin. Place with the skin side up. Do not turn.

When you turn poultry, ensure that the breast side or the skin side is underneath at first.

Meat

Baste lean meat with fat as required or cover it with strips of bacon.

When roasting, add a little liquid if the meat is lean. This liquid should just about cover the bottom of the glass cookware.

Score the rind crosswise.

When the joint is ready, turn off the oven and allow it to rest for a further 10 minutes in the cooking compartment, keeping the door closed. This helps distribute the meat juices more evenly. Wrap the joint in aluminium foil if necessary. The recommended resting time is not included in the indicated cooking time.

It is more convenient to roast and braise meat in cookware. You can take the joint out of the cooking compartment more easily in the cookware, and prepare the sauce in the cookware itself.

The quantity of liquid depends on the type of meat, the material the cookware is made from and on whether or not a lid is used. If preparing meat in an enamelled or dark metal roasting dish, it will need a little more liquid than if cooked in glass cookware.

The liquid in the cookware evaporates when roasting. Carefully pour in more liquid if required.

The distance between the meat and the lid should be at least 3 cm. The meat may rise.

If necessary, braise the meat first by searing it. Add water, wine, vinegar or a similar liquid to the braising liquid. Cover the bottom of the cookware with approx. 1-2 cm of liquid.

Fish

Whole fish does not need to be turned. You can tell when the fish is cooked because the dorsal fin can be removed easily.

If you would like to cook fish on the wire rack, coat the wire rack with a little oil beforehand as this will make it easier to remove the fish later.



Dish	Cookware	Shelf position	Heating function	Temperature	Grill setting	Microwave setting	Steam setting	Cooking time in min	Notes
Duck breast, 500 g	Wire rack + glass tray	3+2	++	-	3	180	3	10-12	Place with the skin side up. Do not turn.
Goose breast, goose legs, 700-900 g	Cookware, uncovered	0	+	-	2	180	-	30-40	Deep cookware without a lid. Do not turn.

Meat

Dish	Cookware	Shelf position	Heating function	Steps	Temperature	Grill setting	Microwave setting	Steam setting	Cooking time in min	Notes
Pot-roasted beef, 1 kg	Cookware, covered	0	+	1	160-170	-	180	-	80-90	
Sirloin, rare, 1.5 kg	Cookware, uncovered	0	+	1	180-190	-	180	-	30-40	Turn halfway through. Leave to stand for 10 minutes afterwards.
Beef steaks x 2-3-3 cm thick, 200 g each	Wire rack + glass tray	3+1		1	-	3	-	-	10-15	
				2	-	3	-	-	5-10	
Pork without rind, 750 g, e.g. neck	Cookware, uncovered	0	++	1	170-180	-	360	3	25-35	Leave to stand for 10 minutes afterwards.
Pork with rind, 1 kg, e.g. shoulder	Cookware, uncovered	0	++	1	170-180	-	180	3	60-80	Score the rind. Leave to stand for 10 minutes afterwards. Do not turn.
Pork loin 500-600 g	Cookware, uncovered	0	+	1	180-190	-	180	-	35-40	Leave to stand for 10 minutes afterwards.
Pork neck steaks x 2-3, 2-3 cm thick, 120 g each	Wire rack + glass tray	3+1		1	-	2	-	-	15-20	
				2	-	2	-	-	10-15	
Grilling sausages x 4-6, 150 g each	Wire rack + glass tray	3+1		1	-	3	-	-	10-15	
				2	-	3	-	-	5-10	
Meat loaf, 750 g	Cookware, uncovered	0	++	1	190	-	360	3	15-20	Leave to stand for 10 minutes afterwards.

Fish

Dish	Cookware	Shelf position	Heating function	Temperature in °C	Grill setting	Microwave setting	Steam setting	Cooking time in min
Fish fillet, fresh, 400 g	Glass tray + steaming tray	3		-	-	-	3	15-17
Fish fillet pieces, frozen, 400 g	Cookware, covered	3		-	-	-	3	18-20
Fish fillet pieces, frozen, 800 g	Glass tray + steaming tray	3		-	-	-	3	23-25
Fish fillet, au gratin, 500 g	Cookware, uncovered	0	+	-	3	600	-	10-15

Dish	Cookware	Shelf position	Heating function	Temperature in °C	Grill setting	Microwave setting	Steam setting	Cooking time in min
Fish steaks x 2-3, 150 g each	Wire rack + glass tray	3+1		-	3	-	-	8-12
Fish, whole, e.g. trout, x 2-3, 300 g each	Glass tray + steaming tray	3		-	-	-	3	18-22

Tips for roasting and braising

The roast is too dark and the crackling is burned in places, and/or the roast is too dry.	Check the shelf position and temperature. Select a lower temperature the next time and reduce the roasting time if necessary.
The crackling is too thin.	Increase the temperature or switch the grill on briefly at the end of the roasting time.
The roast looks good but the juices have caught.	Next time use a smaller roasting dish and add more liquid if necessary.
The roast looks good but the juices are too clear and watery.	Next time use a larger roasting dish and add less liquid if necessary.
The meat catches during braising.	The roasting dish and lid must fit together well and close properly. Reduce the temperature and add more liquid when braising if necessary.

Vegetables and side dishes

Here you can find information about how best to cook different types of vegetables, rice, potatoes and frozen potato products quickly.

Microwave

Always cook vegetables in a suitable item of cookware and keep them covered. Cook rice in a deep pot with a lid and add the quantity of liquid indicated in the table.

Steaming

Use the glass tray and the steaming tray to steam food. Use the portion sizes listed in the settings table. Larger pieces will take longer to cook and smaller ones will cook more quickly. The cooking time also depends on









the quality and the ripeness of the food. The settings indicated are therefore intended as a guide only.

Always distribute the food evenly in the cookware. It will not cook evenly if the food is piled up to varying heights. Do not stack pressure-sensitive food too high in the steaming tray.

Fill the water tank up to the "max." mark. If the water tank runs out of water while the appliance is in operation, the appliance is paused. You will be alerted to this by a message on the display.

















Couscous

Add water or liquid in the indicated ratio. For example, with a ratio of 1:2, use 200 ml of liquid for every 100 ml of liquid.

Dish	Cookware	Shelf position	Heating function	Steps	Temperature	Microwave setting	Steam setting	Cooking time in min
Artichokes, whole, fresh	Glass tray + steaming tray	3		1	-	-	3	35-40
Spinach leaves, fresh, 250 g	Glass tray + steaming tray	3		1	-	-	3	5-7
Cauliflower, whole, fresh	Glass tray + steaming tray	2		1	-	-	3	28-35
Broccoli, whole, fresh, 500 g	Glass tray + steaming tray	2		1	-	-	3	20-23
Broccoli florets, frozen, 500 g	Glass tray + steaming tray	3		1	-	-	3	14-16
Vegetables, fresh, 250 g*	Cookware, covered	0		1	-	600	-	6-10
Vegetables, fresh, 500 g*	Cookware, covered	0		1	-	600	-	10-15
Corn on the cob, fresh, x 2	Glass tray + steaming tray	3		1	-	-	3	25-35

*Stir occasionally

**Water tank may need to be refilled during cooking

Dish	Cookware	Shelf position	Heating function	Steps	Temperature	Microwave setting	Steam setting	Cooking time in min
Mixed vegetables, frozen, 250 g	Glass tray + steaming tray	3		1	-	-	3	12-15
Steaming sliced carrots, 500 g	Glass tray + steaming tray	3		1	-	-	3	18-20
Sliced leeks, fresh, 500 g	Glass tray + steaming tray	3		1	-	-	3	10-12
Green beans, fresh, 500 g	Glass tray + steaming tray	3		1	-	-	3	18-20
Beetroot, whole, 500 g	Glass tray + steaming tray	3		1	-	-	3	50-60
Asparagus, green, 250 g	Glass tray + steaming tray	3		1	-	-	3	10-15
Steaming sliced courgettes, 500 g	Glass tray + steaming tray	3		1	-	-	3	12-14
Potatoes, quartered, 250 g	Glass tray + steaming tray	3		1	-	-	3	28-30
Potatoes, quartered, 500 g	Glass tray + steaming tray	3		1	-	-	3	30-32
Potatoes, quartered, 750 g**	Glass tray + steaming tray	3		1	-	-	3	32-35
Chips, frozen	Glass tray	2		1	190-210	-	-	30-40
Rösti, frozen	Glass tray	2		1	190-210	-	-	25-35
Croquettes, frozen	Glass tray	2		1	190-210	-	-	25-35
125 g rice + 300 ml water	Cookware, covered	0		1	-	600	-	4-6
				2	-	180	-	12-15
250 g rice + 500 ml water	Cookware, covered	0		1	-	600	-	6-8
				2	-	180	-	15-18
Couscous, 1:2	Glass tray	3		1	-	-	3	3-10

*Stir occasionally
**Water tank may need to be refilled during cooking







Desserts

You can use your appliance to quickly prepare delicious desserts.

Observe the notes in the settings table.

Rice pudding

Add milk in the indicated ratio. For example, with a ratio of 1:2.5, use 250 ml of milk for every 100 ml of pudding rice.

Dish	Cookware	Shelf position	Heating function	Microwave setting	Steam setting	Cooking time in min
Crème caramel	Glass tray + Soufflé dishes	3		-	3	40-50
Yeast dumplings	Glass tray	3		-	2	20-25
Rice pudding 1:2.5	Glass tray	3		-	3	30-40
Fruit, compote, 500 g	Glass tray	3		-	3	9-12
Microwave popcorn, 1 x 100 g bag	Cookware, covered	0		600	-	3-5
Desserts, e.g. blancmange (instant) 500 ml*	Cookware, covered	0		600	-	6-8

*Stir occasionally

Acrylamide in foodstuffs

Which foods are affected?

Acrylamide is mainly produced in grain and potato

products that are heated to high temperatures, such as crisps, chips, toast, bread rolls, bread, fine baked goods (biscuits, gingerbread, cookies).

Tips for keeping acrylamide to a minimum when preparing food

General	Keep cooking times as short as possible. Cook food until it is golden brown, but not too dark. Large, thick pieces of food contain less acrylamide.
Baking	Use hot air at no higher than 180 °C; egg or egg yolk reduces the production of acrylamide.
Biscuits	Use hot air at no higher than 180 °C; egg or egg yolk reduces the production of acrylamide.
Oven chips	Spread out a single layer evenly on the accessory. Cook at least 400 g each time so that the chips do not dry out.

Test dishes

These tables have been produced for test institutes to facilitate inspection of the appliance.





In accordance with IEC 60350-1 and IEC 60705.

Baking

Notes

- The settings apply to food that is placed into a cold cooking compartment.

- Observe the notes about preheating in the tables. The settings apply without rapid heating.
- When baking, use the lower of the listed temperatures to begin with.
- The values in the table apply to food placed in a cold oven.
- Place baking tins on the wire rack.

Dish	Cookware	Shelf position	Heating function	Temperature in °C	Cooking time in min
Viennese whirls	Glass tray	2		160-170	30-35
Small cakes*	Glass tray	2		160-170	20-25
Hot water sponge cake	26 cm springform cake tin	1		160-170	40-50
Double-crust apple pie	20 cm springform cake tin	2		170-190	80-100

*Preheat the oven for 5 minutes

Preparing food with a microwave



When preparing food in a microwave, always use heat-resistant cookware that is suitable for microwave use.

Observe the notes on cookware suitable for microwaves. → "Microwave" on page 16

Microwave defrosting

Dish	Cookware	Shelf position	Heating function	Weight	Steps	Microwave setting	Cooking time in min
Defrosting meat	Cookware, uncovered	0		500 g	1	180	7
					2	90	8-12

Microwave cooking

Dish	Cookware	Shelf position	Heating function	Weight	Steps	Microwave setting	Cooking time in min
Custard	Cookware, uncovered	0		1000 g	1	360	18-20
					2	180	18-22
Sponge cake	Cookware, uncovered	0		475 g	1	600	8-10
Meatballs	Cookware, uncovered	0		900 g	1	600	20-25

Combined microwave cooking

Dish	Cookware	Shelf position	Heating function	Temperature in °C	Grill setting	Microwave setting	Cooking time in min	Notes
Potato gratin	Cookware, uncovered	0	+	-	1	360	25-32	
Cake, 700 g	Cookware, uncovered	1	+	190-200	-	180	20-27	
Chicken	Cookware, uncovered	0	+	190	-	360	30-45	Breast side down. Deep cookware without a lid. Turn half-way through the cooking time.

Steaming

Place the glass tray with steamer basket on shelf position 3.

Dish	Cookware	Shelf position	Heating function	Steam setting	Cooking time in min	Notes
Peas, frozen, 1000 g	Glass tray + steaming tray	3		3	-	The test is complete once the coldest area has reached 85 °C.
Broccoli, fresh, 300 g	Glass tray + steaming tray	3		3	10 - 12	
Broccoli, fresh, one container	Glass tray + steaming tray	3		3	16 - 18	

Grilling

Place the glass tray underneath the wire rack to catch the liquid and keep the cooking compartment cleaner.

The values in the table apply to food placed in a cold oven.

Dish	Cookware	Shelf position	Heating function	Grill setting	Cooking time in min	Notes
Toasting bread	Wire rack	3		3	4-5	
Beefburgers, x 12	Wire rack + glass tray	3+1		3	35-45	Turn half-way through

BSH Hausgeräte GmbH

Carl-Wery-Str. 34
81739 München

GERMANY

In respect of products placed onto the
UK market, the Producer is:

BSH Home Appliances Ltd
Grand Union House
Old Wolverton Road,
Wolverton, Milton Keynes
MK12 5PT
United Kingdom

Manufactured by BSH Hausgeräte GmbH under Trademark License of Siemens AG

siemens-home.bsh-group.com



9001277298 (000909)