



# VACUUM CLEANER VU1

## CORDLESS WET DRY

---

## INSTRUCTION MANUAL

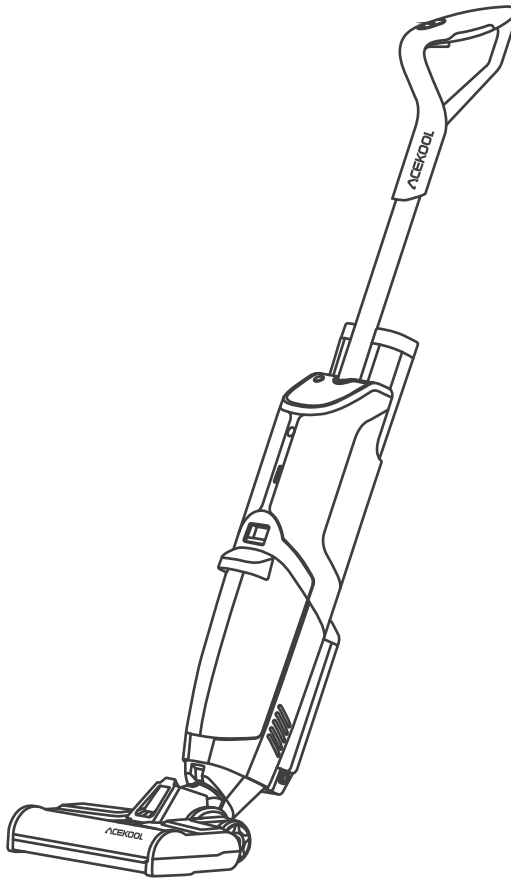

For your safety and continued enjoyment of this product, always read the instruction manual carefully before using.

# CONTENTS

■ Configuration .....	01
■ Packing List .....	02
■ Product View .....	03
■ Digital Display .....	07
■ Operations .....	08
■ Care and Maintenance .....	12
■ Cleaning .....	14
■ Specifications .....	14
■ Troubleshooting .....	15

## Configuration

- This product is for home use. Please do not use it outdoors.
- Do not disassemble, repair, or refit cleaner without authorization.
- Do not modify or attempt to repair cleaner except as indicated in the manual for use and care.
- Do not use the product in an environment with a risk of fire or explosion.
- Do not use cleaner to pick up flammable materials, such as gasoline, lighter fluid.
- Do not use cleaner to pick up toxic material.
- Do not use cleaner to pick up foam liquids.
- Do not use cleaner to pick up the paint, pigments, and corrosive liquids.
- Do not use cleaner to pick up the hard or sharp objects, such as nails, screws, glass.
- Do not use cleaner to pick up the things that are burning or smoking, such as hot ashes, cigarettes.
- Do not put any object into openings, keep openings free of dust, hair, and any thing that may reduce airflow.
- Do not wash or soak the main body and electronic accessories in water.
- Do not allow metal and conductive materials to contact the battery.
- Do not allow to be used as a toy. Close attention is necessary when used by or near children.
- Do not touch the charging plug and docking station with wet hands.
- Always should be protected from long-term exposure to sunlight.
- Do not place cleaner near cigarette butts, lighters, or other open fires.
- Keep hair, fingers, and other parts of the body away from openings and moving parts of the appliance.
- Only the original power adapter can be used.
- When the metal part of the power plug is dusty, please wipe it with a dry cloth.
- The power adapter is applied to a 100-240V AC voltage. Please plug into the socket properly and keep away from the children.
- The operating temperature of the product ranges from 0°C-40°C; please do not use it in a high-temperature environment
- Plastic film can be dangerous, please keep away from babies and children.
- Please unplug the charger from the electrical socket when not in use or before cleaning.
- Please keep cleaner away from the metal objects, such as coins, paper clips when the battery pack is not in use.
- Do not use a battery pack that is damaged.
- Do not block the air inlet or air outlet in case of overheating.
- Do not shake cleaner hard in case the dirty water goes into the vacuum motor.
- Battery pack and charging station output terminals are not to be short-circuited.
- Please remove the battery from cleaner I before the cleaner is scrapped.
- Please empty it in time when the dirty water box is full.
- Please ensure the cleaner is upright when moving cleaner in case the dirty water goes into the vacuum motor.

## Packing List



Handle

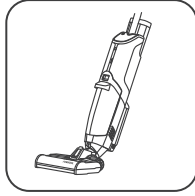

Main Body

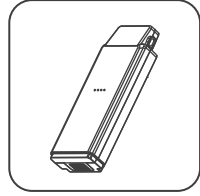

Li-ion Battery Pack

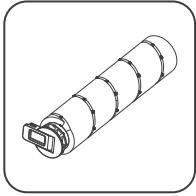

Roller Brush

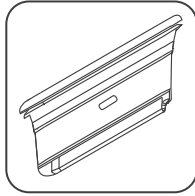

HEPA Filter

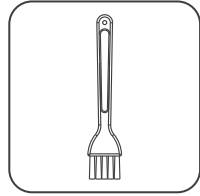

HEPA Hard Brush

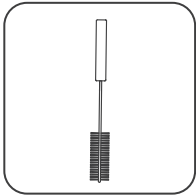

Cleaning Tool

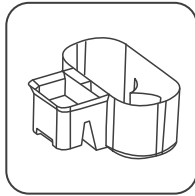

Drying Tray

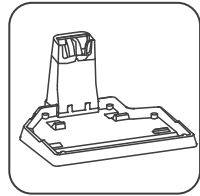

Charging Station

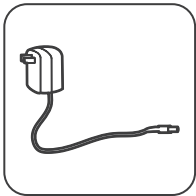

Adapter

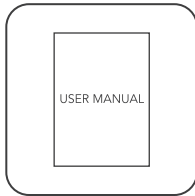

User Manual

Accessories may be slightly different, the pictures are for reference, please subject to the received products or confirm with the seller.

## Product View

### Front View

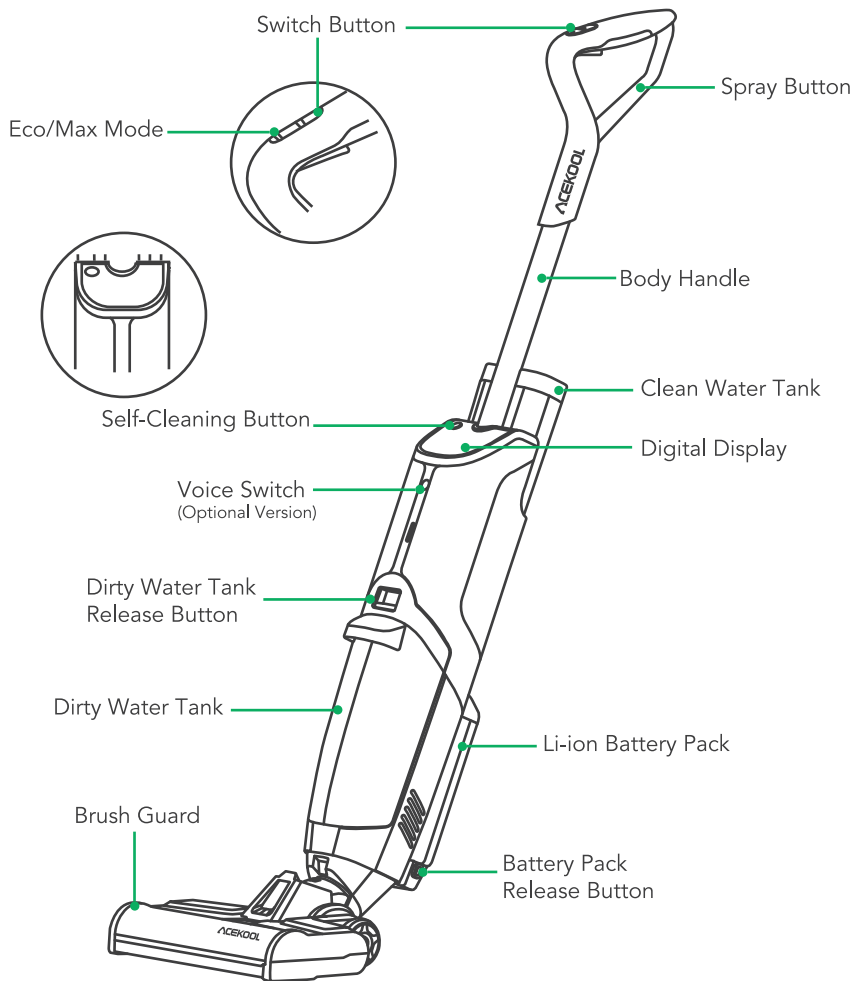

## Back View & Clean Water Tank

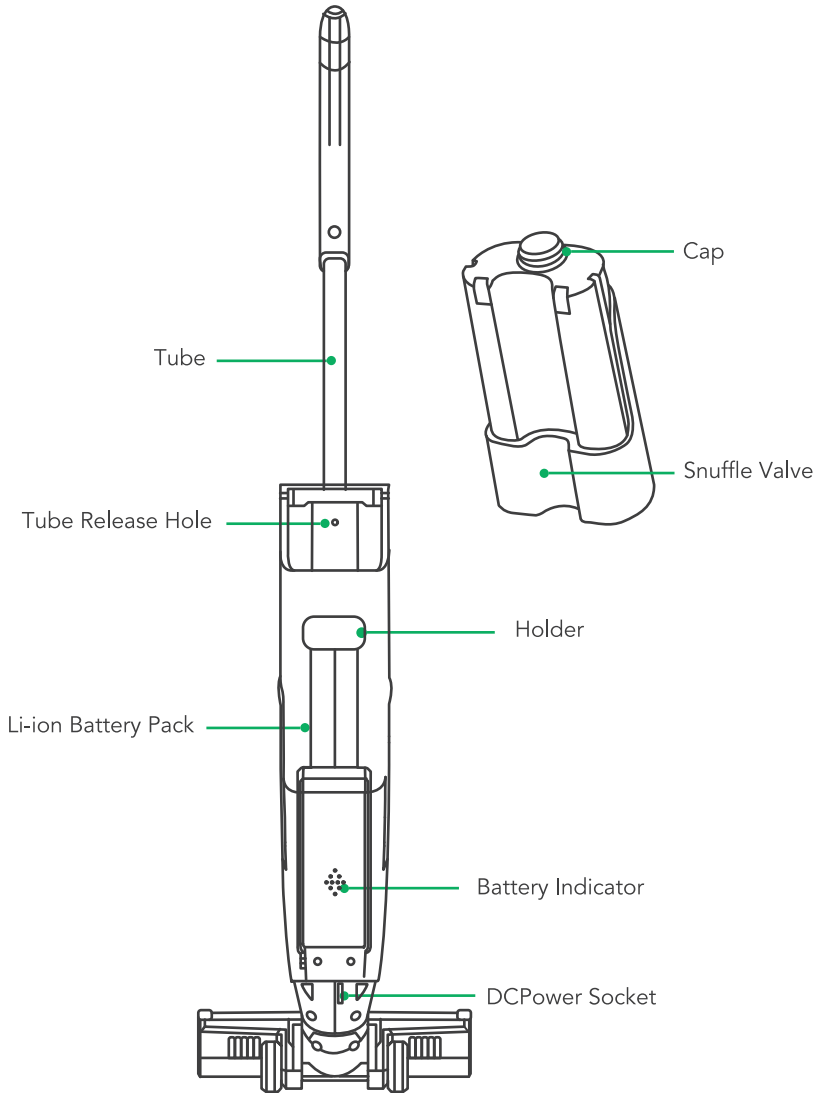

## Brush Base

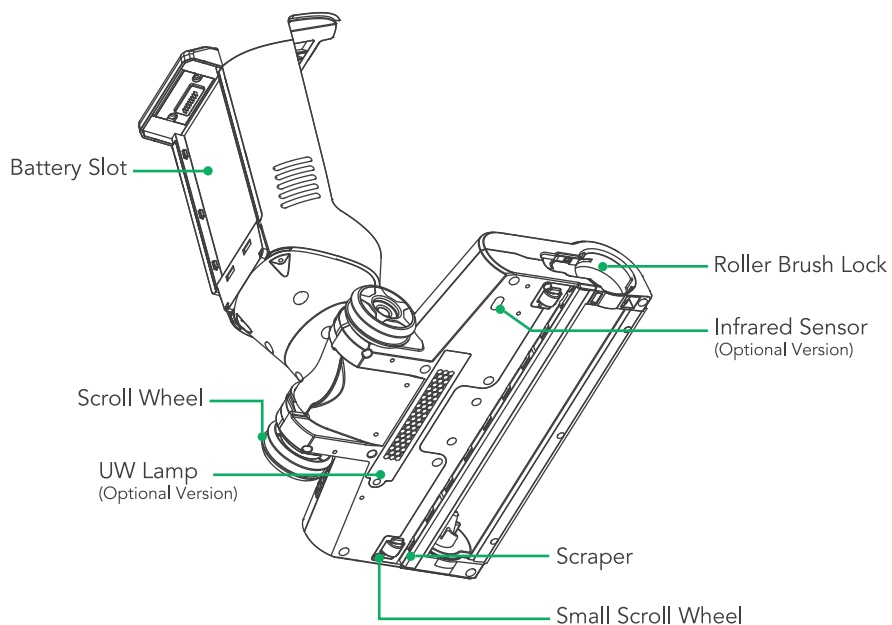

## Charging Station

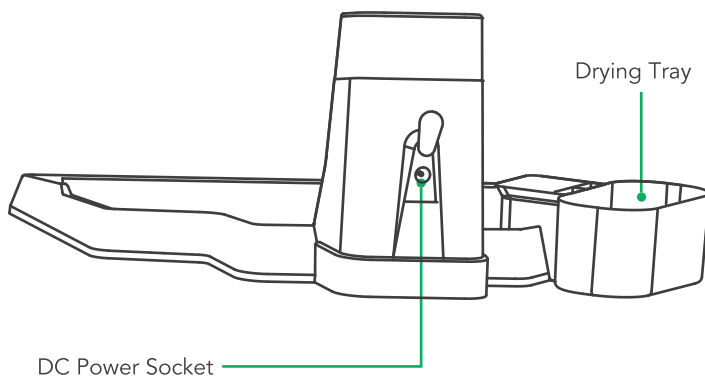

## Digital Display



 The indicator will light up white when the cleaner is in Eco Mode.

 The indicator will light up white when the cleaner is in Max Mode.

**88:88** It shows the Working Time from “Switch on” to “now”.

 The indicator will flash RED slowly when Clean Water Tank is short of water, please fill up with clean water.

 The indicator will flash RED slowly when Dirty Water Tank is full, please empty the Dirty Water Tank in time.

 Press the Self-Cleaning Button, the indicator will flash white slowly, and cleaner will enter the self-cleaning mode.

 Battery Indicator, the indicator will flash white slowly when charging, it will stop flashing after fully charged.

The indicators and the display may be slightly different with the final product, please subject to the actual product.



## Operations

### Assemble

- 1 Take out the Handle, Main Body, Li-ion Battery Pack, Clean Water Tank, Dirty Water Tank Set, Roller Brush, Charging Station, Drying Tray, Cleaning Tool from the package.
- 2 Insert the handle into main body of cleaner until you hear a click.
- 3 Turn over the clean water tank, insert it into the main body along with the clean water tank slot until you hear a click.
- 4 Press the release button of Li-ion battery pack, then put the battery pack into the battery slot, and push it up slightly until you hear a click.

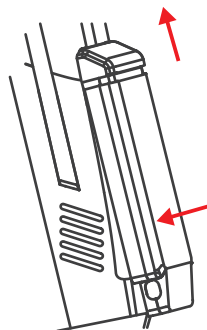
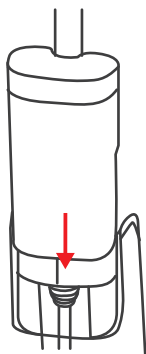
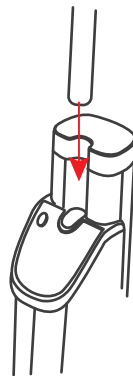

- 5 Align the bottom of dirty water tank with the inlet, then push it inwards until you hear a click.

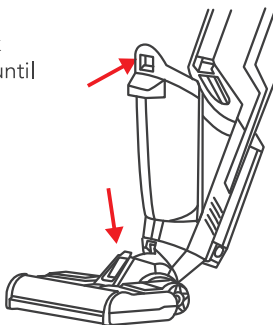

- 6 Insert the roller brush into the base of the brush, rotate the roller brush so that the brush can align with the brush, meanwhile, make sure that the lock can align with the lock hole, then lock the roller brush.

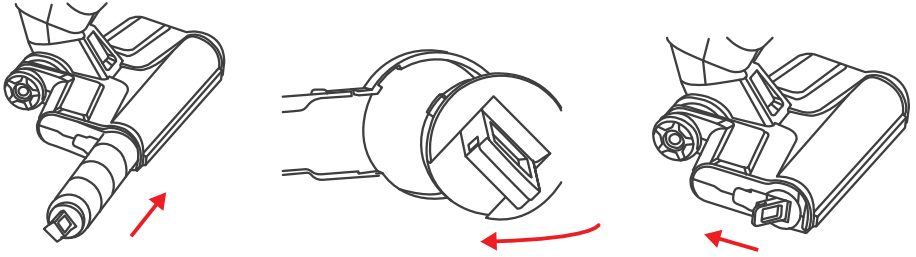

## Filling up the Clean Water Tank

- 1 The cleaning water tank is located on the back of the main body. Grasp the top of the water tank with your fingers and pull it upwards to remove it.



- 2 Unscrew the water cap counterclockwise as below and add some water, then screw it and insert the clean water tank into the cleaner.

Do not tighten the cover too tightly or too loosely, otherwise the cover may be damaged or the water tank may leak.

- The user can also add some non-corrosive or flammable liquid cleaning solutions to clean the floor, do not add dirty water to the cleaning water tank.

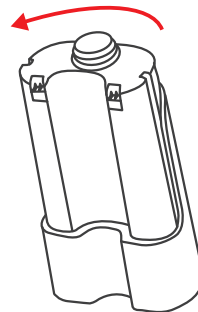

- It is normal if there is water in the water tank at the first use, tests and inspections are proceeded before products leaving the factory.

## Charging the Cleaner

- 1 Insert the drying tray into the charging station as follows.
- 2 Place the charging station near the wall, plug the DC power socket of the adapter into the DC power socket of the charging station, and then plug the adapter into the power socket.

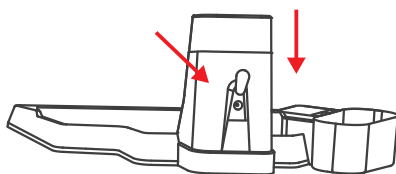

### 3 Charging:

Put the cleaner on the charging station and insert the adapter, then start charging.

Remove the Li-ion battery pack from the main body and charge it directly.

**Note:** Please charge the cleaner for 12 hours for the first time.  
Please ensure the 4 hours fully charged for max running time.

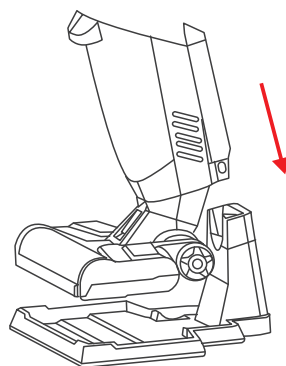

## Cleaning Floor with the Cleaner

- 1 Check the Handle, the clean water tank, the dirty water tank, the Li-ion battery pack, the roller brush, make sure all of them are installed correctly and tightly.
- 2 Press the switch button on the handle to turn on the cleaner. Press the Eco/Max Mode button to switch the suction power.

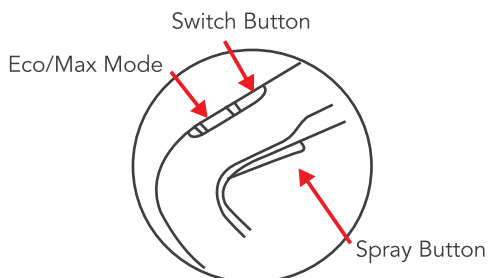

**Important tips:**

- Please choose the hard roller brush for areas with a short rug.
- Please DO NOT use cleaner in the LONG rug areas.
- Please DO NOT use cleaner in the delicate rugs, silk, or similar floors.
- Please DO NOT SPRAY on the rugs.

**3** There will be Voice Assistance providing operation support. This function can be switched off by pressing the voice switch button.

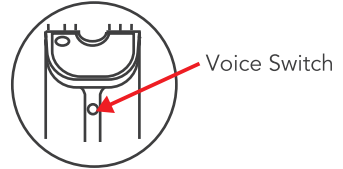

- 4** Hold the spray button for 8 seconds to prime the cleaning water/solutions before each use. Spray the water according to your personal use during the cleaning.
- 5** Hold the handle and pull the cleaner forward and backward to clean your floors.
- 6** The angle range of handle tilt must be within 60.5 degree(up and down), please do not shake it in use.

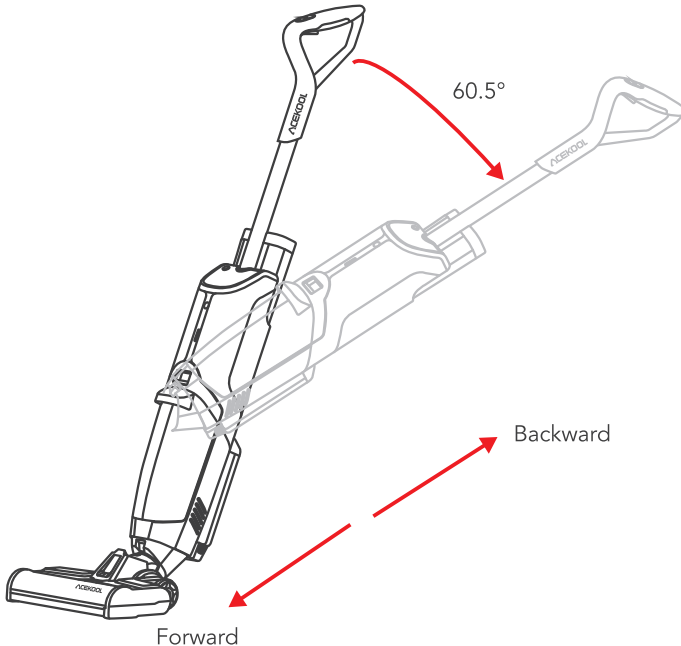

- 6 Please clean the dirty water tank after each use of cleaning.

### Important tips:

- Please DO NOT run over the edges of the rugs.
- The dirty Water Tank must be cleaned as soon as the cleaning work finished, or it will be stinky.
- DO NOT turn the main body over before cleaning the dirty water tank, or the dirty water will flow into the vacuum motor and damage cleaner.
- Please clean and dry the HEPA and Filter after each use.

## Self-Cleaning

The cleaner can clean the roller brush and pipeline automatically on Self-Cleaning Base:

- 1 Please make sure there is enough clean water in the clean water tank, empty dirty water tank before self-cleaning.
- 2 Place cleaner on the charging station (I), plug in the power supply well.
- 3 Press the Self-Cleaning button(2), the indicator  will be white and flash slowly, and the cleaner will spray the clean water, clean the roller brush and pipeline automatically, meanwhile, it will vacuum the dirty water into the dirty water tank.
- 4 Please unplug the power supply and clean the dirty water tank once the self-cleaning mode finished to avoid getting stinky.

Note: The Self-Cleaning can only be applied when charging on the charging station.

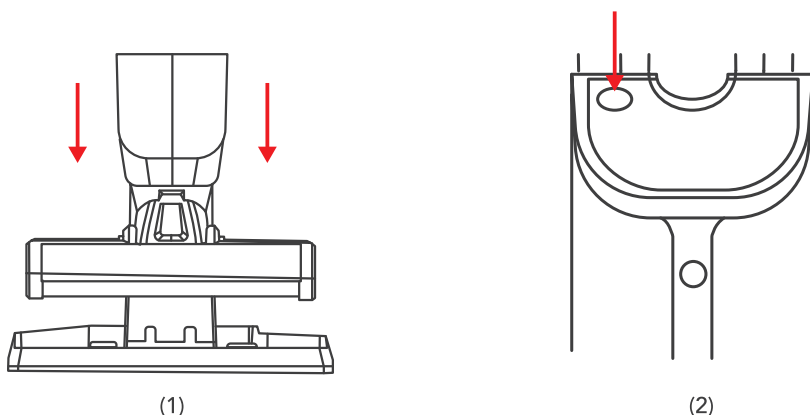

## Care and Maintenance

Please unplug the power supply, turn off the switch, and remove the battery pack out before care and maintenance.

### 1 For daily care and maintenance

Use a soft dry mop to wipe the main body, the charging station; use a soft moist cloth to wipe the brush base, scraper, infrared sensor.

### 2 Roller Brush Cleaning

Release the lock button of the roller brush, rotate the brush counterclockwise, then pull the brush out, clean the brush, and brush guard with a cleaning tool.

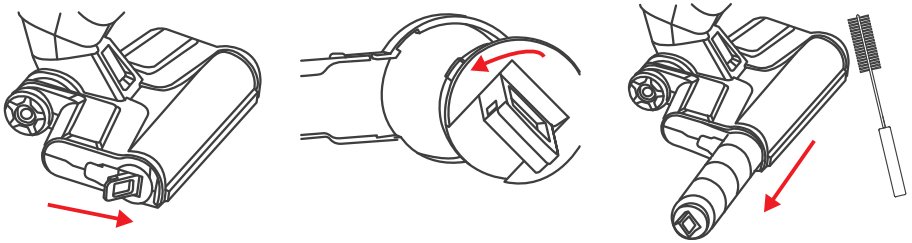

### 3 Dirty Water Cleaning

- Press the release button of dirty water tank, and take the dirty water tank out. Take out the HEPA and the cap.

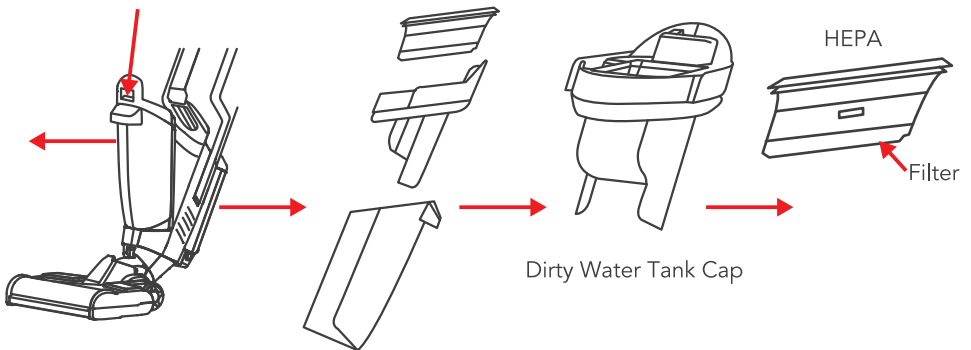

- Pour the debris into the dustbin, pour the dirty water into washbasin. Clean the dirty water tank, the cap, and the HEPA with clean water.



#### 4 Charging Station & Drying Tray Cleaning

- Unplug the power supply and take the main body out before cleaning.
- Pour out the dirty water of Charging Station, use a soft dry mop to wipe the charging station and Drying Tray.

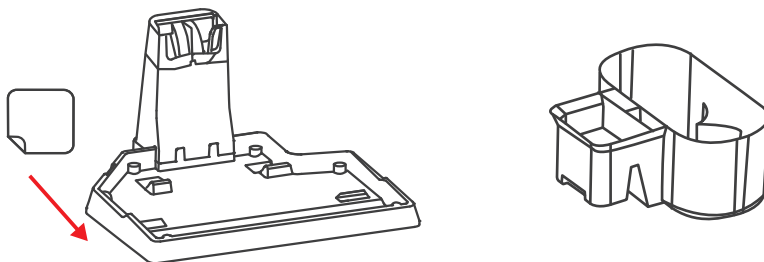

#### 5 Storage

- Please dry the main body, clean water tank, dirty water tank, brush base, HEPA, Charging Station, drying tray, then store them.
- The roller brush can be stored in the drying tray.

##### Notice:

- The Dirty Water Tank must be cleaned and dried after every single cleaning to avoid mildew or smell.
- The machine must be stored in a dry and ventilated place without heat sources.
- Please keep the machine away from the direct sunlight.
- The battery pack should be fully charged every 3 months at least to avoid battery damage.

## Cleaning

Part	Cleaning / Replacement Frequency Recommended
Clean Water Tank	Cleaning after each use.
Dirty Water Tank	Cleaning after each use.
HEPA	Cleaning after each use; Replacement every 3-6 months
Floater	Cleaning after each use.
Brush Guard	Cleaning after each use.
Roller Brushes	Cleaning after each use; Replacement every 3-6 months.

**Note:**

Above frequency is only for your reference. The final cleaning/replacement frequency should depend on the usage.

## Specifications

Output Voltage: 30V/0.8A

Power Consumption: 150 W

Adapter: 100-240VAC 60Hz

Battery Type: Li-ion Battery

Battery Capacity: 2600 mAh

Battery Voltage: 25.2 V

Clean Water Tank Capacity: 680 ml

Dirty Water Tank Capacity: 450 ml

Working Time: About 30 mins

Charging Time: About 4 hours

Working Mode: Eco Mode/Max Mode



## Trouble Shooting

Problems	Possible Reasons	Solutions
Cleaner cannot be charged	The power supply does not connect well	Please check the connection of power supply
	Cleaner isn't connected well with charging station.	Please replace cleaner on the charging station
The handle control doesn't work	The battery capacity is low	Please check the battery capacity and fully charge it
	The handled doesn't connect well	Please re-install the handle
Cleaner doesn't work	The dirty water tank is full	Please empty the dirty water tank
	The dirty water tank is not installed	Please check and install the dirty water tank
	The roller brush is not installed	Please check and install the roller brush
The indicator display of clean water tank is incorrect	Uncalibrated	Take off the Clean Water tank, then start to clean and spray, turn cleaner off until draining the pipe. Then press the "Switch Bolton" and "Eco/Max Button" for seconds until the digital display flash two times, then check again.
The vacuum is getting weaker	The HEPA is blocked	Please check and clean the HEPA
	The HEPA is wet	Please dry the HEPA first.
	The Scraper is not installed well	Please check and re-install the scraper
The clean water tank is leaking	The clean water volume is higher than snuffle valve	Pour out water until the volume is lower than snuffle valve
	The clean water tank is not installed well	Please re-install the water tank
	The cap is not screwed well	Please screw the cap well
No water comes out when spraying	The clean water tank is empty	Please fill up the Clean Water Tank
	The clean water tank is not installed well	Please re install the water tank
No voice assistance	The voice function is switch off	Turn on the voice switch
	The version exclude voice.	Please check and confirm with local seller

Problems	Possible Reasons	Solutions
Cleaner doesn't work in self-cleaning mode	Cleaner isn't connected with power supply	Please check and connect with the power supply well
	The dirty water tank is full	Please empty the dirty water tank
	Lack of water	Please fill up the clean water tank
There are water drops at air outlet	The HEPA isn't installed	Please check and install the HEPA
	Cleaner was tilted hard	Use the machine correctly
	Cleaner vacuums the foam liquid	Empty the dirty water tank in time
Cleaner moves hard	The roller brushed isn't installed well	Please check and re-install the Roller Brush as guide
Error Code	Causes	Solutions
FF:01	Charging overvoltage	Replace the adaptor
FF:02	Charging overcurrent	Replace the adaptor
FF:03	NTC open/short circuit	Replace the battery pack
FF:04	Internal disconnection of the battery pack	Replace the battery pack
FF:05	Rechargeable battery voltage is too low	Replace the battery pack
FF:06	Rechargeable battery voltage difference is too large	Replace the battery pack
FF:07	High discharging temperature	The battery pack temperature is high, please assure battery pack temperature returns to normal before reuse
FF:08	High charging temperature	The battery pack temperature is high, please assure battery pack temperature returns to normal before charging
FF:09	Low charging temperature	The battery pack temperature is low, please assure battery pack temperature returns to normal before charging
FF:10	Roller brush overcurrent	Check if there is any dirt (like pet hair) at the roller brush to be cleaned, then make it clean
FF:12	No dirty water tank installed	Install dirty water tank

**ACEKOOOL**

— Make Life Easier —

Model: B61

Email: [support@acekool.vip](mailto:support@acekool.vip)

Website: <https://www.acekool.vip>

Made in China

