

zafferano

LAMPES A PORTER

ISTRUZIONI D'USO | INSTRUCTIONS FOR USE | GEBRAUCHSANWEISUNG  
| MODE D'EMPLOI | INSTRUCCIONES DE USO

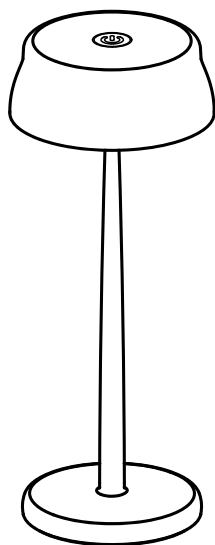

# sister light

Design Federico de Majo

Lampada da tavolo ricaricabile | Rechargeable table lamp | Aufladbare Tischlamp  
| Lampe de table rechargeable | Lámpara de mesa recargable





LAMPES A PORTER

# indice | index | índice



IT

<b>SISTER LIGHT</b> LAMPADA DA TAVOLO RICARICABILE	1
ISTRUZIONI D'USO	2
CONFIGURAZIONE MENU	3
RESET DELLE IMPOSTAZIONI	4
ISTRUZIONI DI MONTAGGIO	4



EN

<b>SISTER LIGHT</b> RECHARGEABLE TABLE LAMP	5
INSTRUCTIONS FOR USE	6
CONFIGURATION MENU	7
RESETTING THE SETTINGS	8
ASSEMBLY INSTRUCTIONS	8



DE

<b>SISTER LIGHT</b> AUFLADBARE TISCHLAMP	9
GEBRAUCHSANWEISUNG	10
MENÜ-KONFIGURATION	11
RESET DER EINSTELLUNGEN	12
MONTAGEANLEITUNG	12



FR

<b>SISTER LIGHT</b> LAMPE DE TABLE RECHARGEABLE	13
MODE D'EMPLOI	14
CONFIGURATION MENU	15
RÉINSTALLATION DES PARAMÈTRES	16
NOTICE DE MONTAGE	16



ES

<b>SISTER LIGHT</b> LÁMPARA DE MESA RECARGABLE	17
INSTRUCCIONES DE USO	18
CONFIGURACIÓN MENÚ	19
RESTABLECIMIENTO DE LAS CONFIGURACIONES	20
INSTRUCCIONES DE MONTAJE	20

# sister light

Lampada da tavolo ricaricabile

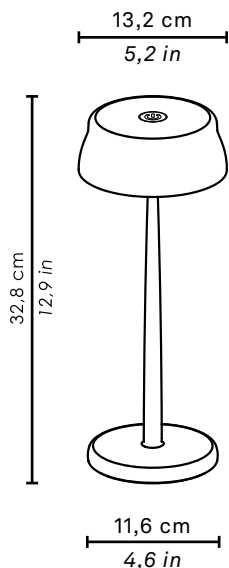

LED NON SOSTITUIBILE

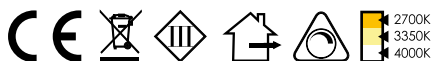

## LED DIMMER

3W • 250lm - 260lm - 270lm • 2700K  
- 3350K - 4000K • IP65 • 220-240V  
50-60Hz • CRI>90 • 5Vdc max 2A  
Ø 13,2 x h 32,8 x Ø 11,6 cm  
Ø 5,2 x h 12,9 x Ø 4,6 in

LD0300A3 alluminio anodizzato  
LD0300O3 oro anodizzato  
LD0300R3 rame anodizzato  
LD0300B3 blu anodizzato  
LD0300V3 verde anodizzato

\* per le istruzioni di montaggio visitare il sito web

## Inclusi

Cavo di ricarica con entrata USB tipo C

Kit per fissaggio magnetico x 2

## Non inclusi

LD0300UC Carica batterie con doppia entrata USB

LD0340RA Caricatore multipresa USB (8xUSB)

LD0300KT Kit per fissaggio meccanico al tavolo \*

BAT04705506701900 Pacco batteria sostitutiva

## 1. Consigli d'uso:

Questo prodotto serve esclusivamente a scopi di illuminazione e:

**A)** Non deve essere esposto a pesanti carichi meccanici o forti contaminazioni; **B)** può essere installato e usato solo previo controllo delle condizioni del prodotto; verificare che non risulti sporco e non abbia subito danneggiamenti durante lo stoccaggio; **C)** l'installazione e la manutenzione vanno eseguite ad apparecchio spento; **D)** modifiche o manomissioni del prodotto e il non rispetto delle indicazioni riportate possono rendere l'apparecchio pericoloso; **E)** i prodotti con grado di protezione 65 (IP65) sono idonei per uso esterno; **F)** per la pulizia di tutte le superfici metalliche e plastiche utilizzare un panno morbido asciutto; **G)** La ditta Zafferano declina ogni responsabilità per danni causati da un proprio prodotto montato in modo non conforme alle istruzioni.

## 2. Dati tecnici:

- Potenza: 3 W
- Volt: DC 5 V
- Flusso luminoso: 2700K 250 lm - 3350K 260 lm - 4000K 270 lm
- LED: HONGLITRONIC 2835 / (8+42 pz) 3 STEP MAC ADAM
- Pacco batteria al litio inclusa: 18650 / 7500mA/H\*3; per le istruzioni di sostituzione del pacco batteria consultare il sito web [www.zafferanoitalia.com](http://www.zafferanoitalia.com); si raccomanda di usare batterie originali per la sostituzione.
- Ricarica standard: 1A - 2A (max 2,5A)
- Ricarica: 5 ore a 2A - 10 ore a 1A
- Durata batteria: 100% 8 ore - 60% 13 ore - 30% 28 ore - 6% 58 ore
- Classe: III
- Grado di protezione: IP65
- CRI ≥ 90
- In riferimento alla norma UNI EN ISO 9227, la resistenza della lampada all'esposizione a nebbia salina neutra (NSS) è garantita per 1500 ore.

## 3. Carica batterie:

- Per caricare il prodotto è possibile usare un carica batterie con entrata USB standard A.
- Carica batterie con doppia entrata USB NON INCLUSO: INPUT 100-240 V AC - 50/60Hz; OUTPUT DC 5V - 2.1 A.
- Per un corretto caricamento della lampada si consiglia di: 1 - collegare il cavo USB all'adattatore; 2 - collegare il cavo USB alla lampada; 3 - collegare la spina alla presa elettrica; 4 - a carica completata scollegare la spina dalla presa elettrica e rimuovere il cavo USB.
- La lampada funziona correttamente anche se collegata alla corrente.
- Si consiglia l'utilizzo del caricatore opzionale e del cavo in dotazione originale. In alternativa utilizzare un cavo e caricatore a 2A certificati.

## 4. Configurazione di fabbrica:

LUMINOSITÀ 100% - K 2700 - CHIAMATA AL TAVOLO OFF - DIMMER ON - FISSAGGIO MECCANICO

## 5. Attenzione:

- Il piano d'appoggio della lampada non deve superare i 15° di inclinazione o rischia la caduta.
- La batteria è fornita delle seguenti protezioni: cortocircuito, sovra scarica, sovralimentazione, sovracorrente, sovratensione.
- Per preservare l'integrità della batteria si consiglia di mantenere la carica tra il 20% minimo e 80% massimo; se la lampada non viene utilizzata per lunghi periodi, si consiglia di procedere periodicamente ad un ciclo di carica/scarica del prodotto.
- Si prega di fare riferimento alle leggi locali per un corretto smaltimento e riciclaggio della batteria.

Visita il nostro sito per ulteriori informazioni, e aggiornamenti sulle caratteristiche del prodotto.

NON PRODOTTO IN ITALIA - IMPORTATO DA

Zafferano srl, Viale dell'Industria, 26 - 31055 Quinto di Treviso - TV - Italia

[www.zafferanoitalia.com](http://www.zafferanoitalia.com)



# istruzioni d'uso

## CONFIGURAZIONE DI FABBRICA

### ACCENSIONE / SPEGNIMENTO

0-1 sec

Rapido tocco sul touch per accendere la lampada

1

3 sec

Leggera pressione per 3 secondi per spegnere la lampada

2

### DIMMERAZIONE

0-1 sec

A lampada accesa, rapido tocco per cambiare la luminosità del dispositivo. La ripetizione degli step è ciclica.

## ALTRE CONFIGURAZIONI

### CHIAMATA AL TAVOLO (SE ON - livello 4 menu configurazione)

2 sec

A lampada accesa, leggera pressione per 2 secondi per attivare la chiamata al tavolo

1

0-1 sec

Rapido tocco per disattivare la chiamata al tavolo

2

### ACCENSIONE / SPEGNIMENTO (SE DIMMER E CHIAMATA AL TAVOLO OFF - livello 3 e 4 menu configurazione)

0-1 sec

Rapido tocco sul touch per accendere la lampada

1

0-1 sec

Rapido tocco sul touch per spegnere la lampada

2

## LED DI SEGNALAZIONE

**LED ROSSO FISSO:** carica della batteria inferiore al 20% si consiglia la ricarica

Quando la carica è esaurita (1%), la lampada non si accende, ma emette tre flash bianchi di allerta - ricaricare

**LED ROSSO LAMPEGGIANTE**  
ricarica in corso

**LED BLU FISSO**  
batteria carica al 100% si consiglia di disconnettere dall'unità di ricarica

Visita il nostro sito per ulteriori informazioni, e aggiornamenti sulle caratteristiche del prodotto.

NON PRODOTTO IN ITALIA - IMPORTATO DA

Zafferano srl, Viale dell'Industria, 26 - 31055 Quinto di Treviso - TV - Italia

[www.zafferanoitalia.com](http://www.zafferanoitalia.com)

# configurazione menù



Il menu di configurazione è composto da quattro livelli consecutivi:

- 1) Impostazione della luminosità di default
- 2) Impostazione della temperatura di colore
- 3) Dimmerazione ON - OFF
- 4) Chiamata al tavolo ON - OFF

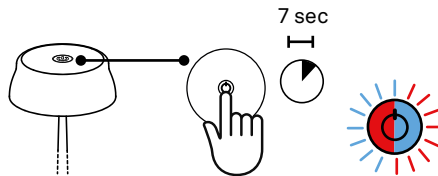

**PER ACCEDERE AL MENU** (primo livello)  
Da lampada spenta, leggera pressione per 7 secondi finché non lampeggia rosso/blu (per 3 volte)

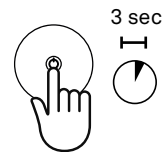

**2b)\* MEMORIZZARE E USCIRE DAL MENU**  
Da qualsiasi livello, leggera pressione per 3 secondi per spegnere la lampada

## LIVELLO 1 - LUMINOSITÀ DI DEFAULT

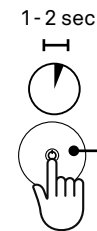
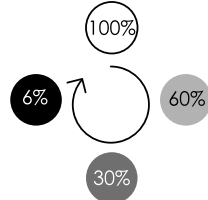
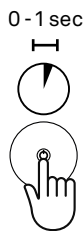

- 1) Rapido tocco per cambiare la luminosità della lampada

- 2a) **MEMORIZZARE E PASSARE AL LIVELLO 2**  
Leggera pressione per 1-2 secondi finché appare un flash  
2b)\*

## LIVELLO 2 - TEMPERATURA DI COLORE

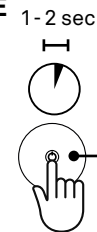
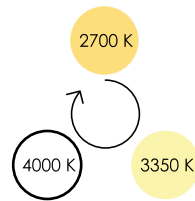
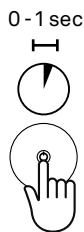

- 1) Rapido tocco per cambiare la temperatura di colore della lampada

- 2a) **MEMORIZZARE E PASSARE AL LIVELLO 3**  
Leggera pressione per 1-2 secondi finché appare un flash  
2b)\*

## LIVELLO 3 - DIMMERAZIONE (LED ROSSO)

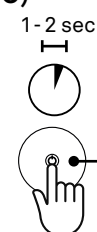
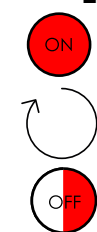
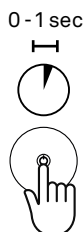

- 1) Rapido tocco per impostare il dimmer ON (LED rosso fisso) o OFF (LED rosso lampeggiante)

- 2a) **MEMORIZZARE E PASSARE AL LIVELLO 4**  
Leggera pressione per 1-2 secondi finché appare un flash  
2b)\*

## LIVELLO 4 - CHIAMATA AL TAVOLO (LED BLU)

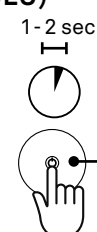
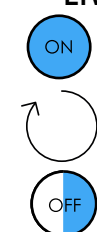
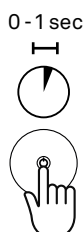

- 1) Rapido tocco per impostare la chiamata al tavolo ON (LED blu fisso) o OFF (LED blu lampeggiante)

- 2a) **MEMORIZZARE E PASSARE AL LIVELLO 1**  
Leggera pressione per 1-2 secondi finché appare un flash  
2b)\*

Visita il nostro sito per ulteriori informazioni, e aggiornamenti sulle caratteristiche del prodotto.

NON PRODOTTO IN ITALIA - IMPORTATO DA

Zafferano srl, Viale dell'Industria, 26 - 31055 Quinto di Treviso - TV - Italia

[www.zafferanoitalia.com](http://www.zafferanoitalia.com)



# reset delle impostazioni

Ripristino della configurazione di fabbrica

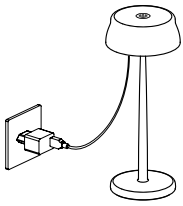

1

Collegare la lampada alla presa di corrente

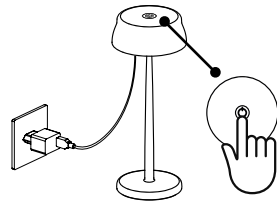

2

Appoggiare il dito sul touch mantenendo la pressione

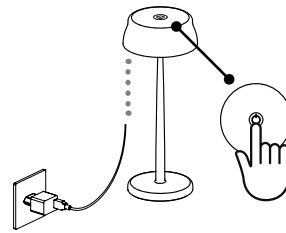

3

Scollegare la lampada dalla presa di corrente

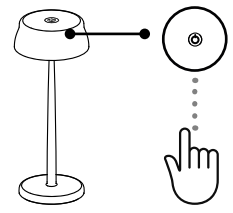

4

Sollevare il dito dal touch

# istruzioni di montaggio

Fissaggio magnetico

INCLUSO

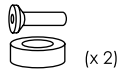

Kit per fissaggio magnetico

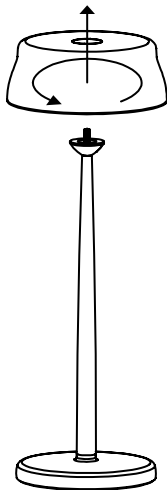

1

Svitare la testa della lampada dal perno filettato

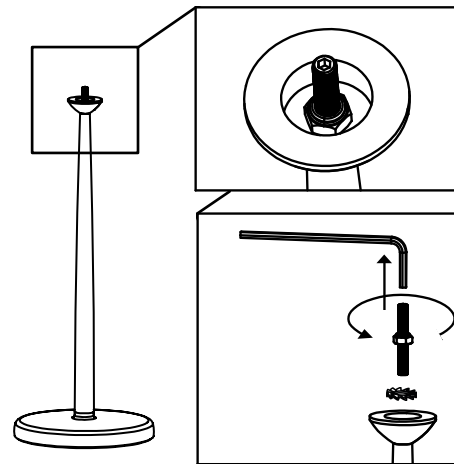

2

Svitare il perno filettato

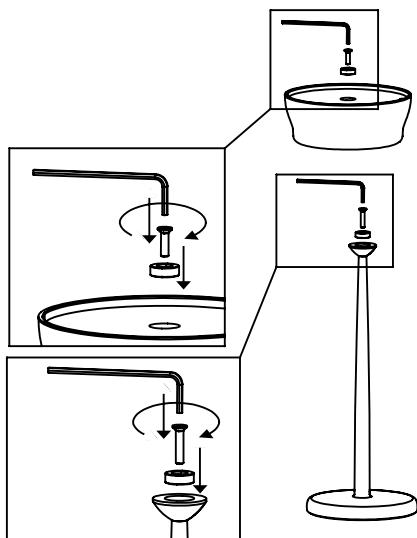

3

Avvitare i magneti

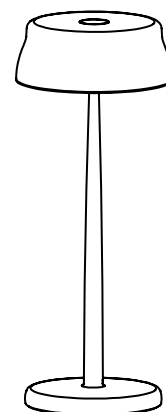

Visita il nostro sito per ulteriori informazioni, e aggiornamenti sulle caratteristiche del prodotto.

NON PRODOTTO IN ITALIA - IMPORTATO DA

Zafferano srl, Viale dell'Industria, 26 - 31055 Quinto di Treviso - TV - Italia

[www.zafferanoitalia.com](http://www.zafferanoitalia.com)

# sister light

Rechargeable table lamp

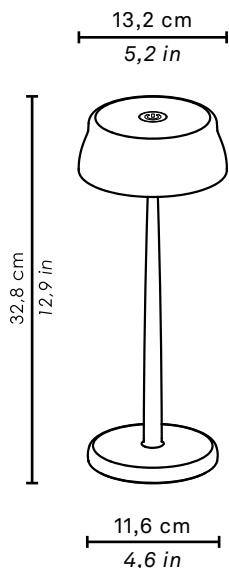

NON-REPLACEABLE LED

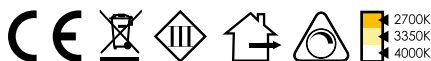

## LED DIMMER

3W • 250lm - 260lm - 270lm • 2700K  
- 3350K - 4000K • IP65 • 220-240V  
50-60Hz • CRI>90 • 5Vdc max 2A  
Ø 13,2 x h 32,8 x Ø 11,6 cm  
Ø 5,2 x h 12,9 x Ø 4,6 in

LD0300A3 anodized aluminium  
LD0300O3 anodized gold  
LD0300R3 anodized copper  
LD0300B3 anodized blue  
LD0300V3 anodized green

\* For the assembly instructions  
visit our website

## Included



Charging cable  
with USB Type C input



Magnetic fixing kit

## Not included

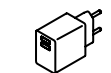

LD0300UC  
Dual USB port power  
charger



LD0340RA  
Multi-socket USB charger  
(8xUSB)



LD0300KT  
Fixing kit to the table \*



BAT04705506701900  
Replacement battery pack

## 1. Tips for use:

This product is exclusively for lighting purposes and:

**A)** It must not be exposed to heavy mechanical loads or contamination; **B)** It can be installed and used only after checking the state of the product; check that is not dirty and has not been damaged during storage; **C)** Installation and maintenance must be carried out when the appliance is switched off; **D)** Any alterations to the product, any tampering and any failure to comply with the instructions provided may make the appliance hazardous; **E)** Products with IP65 protection are suitable for outdoor use; **F)** All metal and plastic surfaces should be cleaned with a soft dry cloth; **G)** The company Zafferano shall not be held liable for any damage caused due to its products being assembled in any manner that does not comply with the instructions provided.

## 2. Technical data:

- Power: 3 W
- Volt: DC 5 V
- Lumen lamp: 2700K 148 lm - 3350K 158 lm - 4000K 166 lm
- LED: HONGLITRONIC 2835 / (8+42 pz) 3 STEP MAC ADAM
- Lithium battery pack included: 18650 / 7500mA/H\*3; for instructions about how to replace the battery pack, please consult the website: [www.zafferanoitalia.com](http://www.zafferanoitalia.com). We recommend using an original battery pack as a replacement.
- Standard charge: 1A - 2A (max 2,5A)
- Charge: 1A 10 h - 2A 5 h
- Battery life: 100% 8 h - 60% 13 h - 30% 28 h - 6% 58 h
- Class: III
- Protection rating: IP65
- CRI≥90
- With reference to the UNI EN ISO 9227 standard, the lamp is guaranteed to resist exposure to neutral salt spray (NSS) for 1,500 hours.

## 3. Charger:

- You can use a charger with Standard-A USB to charge this product.
- *Dual USB port power charger NOT INCLUDED*: INPUT 100-240 V AC - 50/60Hz; OUTPUT DC 5V - 2.1 A.
- To correctly charge the lamp, we recommend that you: 1- Connect the USB cable to the adaptor; 2- Connect the USB cable to the lamp; 3- Put the plug into the electrical socket; 4- When fully charged, disconnect the plug from the electrical socket and remove the USB cable.
- The lamp also operates properly when connected to the mains power supply.
- We recommend using an optional charger and the original cable provided. Alternatively, use a certified cable and a 2A charger.

## 4. Manufacturer's configuration:

100% LUMINOSITY - 2700K - CALL TO TABLE OFF - DIMMER ON - MECHANICAL FIXING

## 5. Important!

- The support surface for the lamp must not exceed a 15° tilt or it will fall.
- The battery is provided with the following protection functions: short circuit, over discharge, over charge, over current, over voltage.
- To preserve the integrity of the battery, we recommend keeping the charge between minimum 20% and maximum 80%; if the lamp is not used for long periods, it is advisable to regularly charge/discharge the product.
- Please refer to local laws for the proper disposal and recycling of the battery.



# instructions for use

## MANUFACTURER'S CONFIGURATION

### SWITCHING ON / OFF

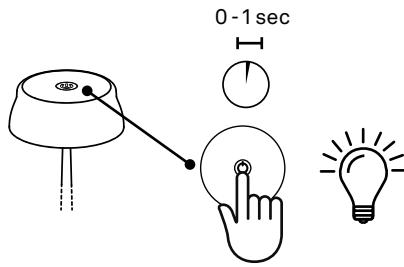

Quickly press the touch sensor to switch on the lamp **1**

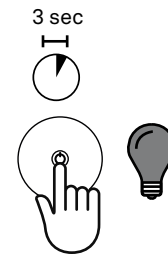

Press lightly for 3 seconds to switch off the lamp **2**

### DIMMER FUNCTION

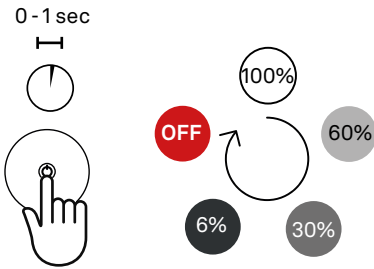

When the lamp is switched on, quickly press the touch sensor to change the luminosity of the appliance. Cyclical step repetition.

### OTHER CONFIGURATIONS

#### CALL TO THE TABLE (IF ON - step 4 of the configuration menu)

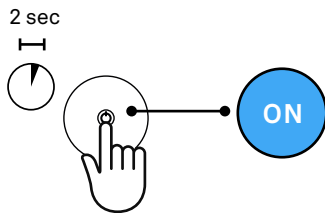

When the lamp is switched on, press lightly for 2 seconds to activate the call to table function **1**

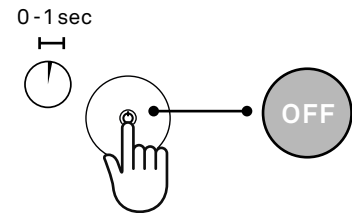

Quickly press the touch sensor to deactivate the call to table **2**

#### SWITCHING ON / OFF (IF DIMMER AND CALL TO THE TABLE FUNCTIONS ARE OFF - step 3 and 4 of the configuration menu)

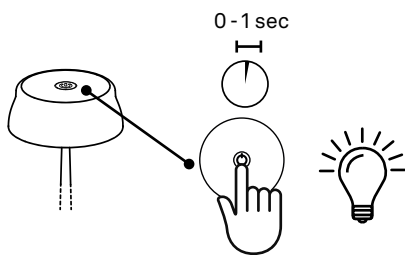

Quickly press the touch sensor to switch on the lamp **1**

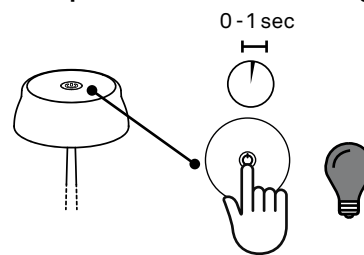

Quickly press the touch sensor to switch off the lamp **2**

### INDICATOR LEDS

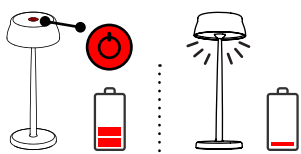

**PERMANENT RED LED**  
the battery charge is lower than 20%, charging is recommended.  
When the charge is depleted (1%), the lamp does not switch on but emits three white flashes as an alert to charge

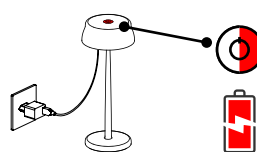

**FLASHING RED LED**  
charging in progress

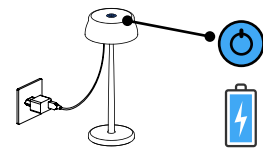

**PERMANENT BLUE LED**  
the battery is 100% charged, disconnection from the power charger is recommended

For more information and updates visit our website

NOT PRODUCED IN ITALY - IMPORTED BY

Zafferano srl, Viale dell'Industria, 26 - 31055 Quinto di Treviso - TV - Italy

[www.zafferanoitalia.com](http://www.zafferanoitalia.com)



# configuration menu



The configuration menu involves four successive setting steps:

- 1) Default luminosity
- 2) Colour temperature (dynamic white)
- 3) Dimmer ON / OFF function
- 4) Call to table ON / OFF function

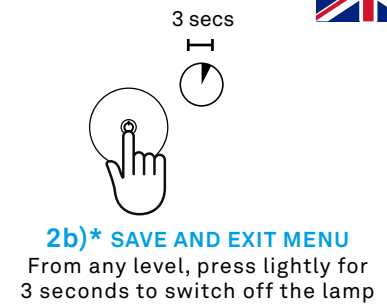
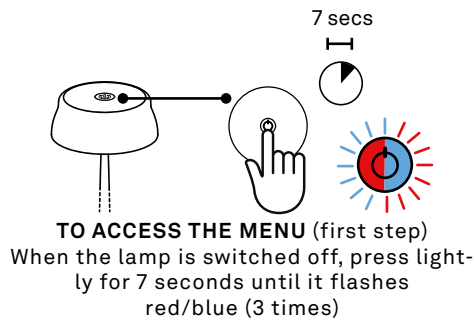

## STEP 1 - DEFAULT LUMINOSITY

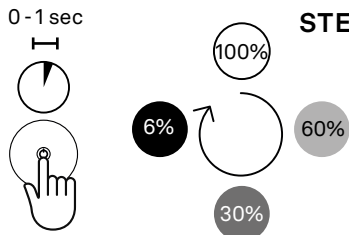

- 1) Quickly press the touch sensor to change the luminosity of the lamp

- 2a) **SAVE AND CONTINUE TO STEP 2**  
Press lightly for 1-2 seconds until a flash appears
- 2b)\*

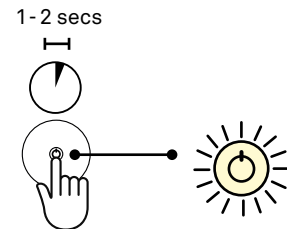

## STEP 2 - COLOUR TEMPERATURE (K) dynamic white

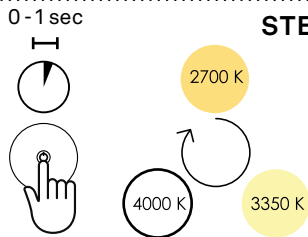

- 1) Quickly press the touch sensor to change the colour temperature of the lamp

- 2a) **SAVE AND CONTINUE TO STEP 3**  
Press lightly for 1-2 seconds until a flash appears
- 2b)\*

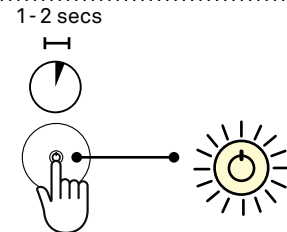

## STEP 3 - DIMMER (RED LED)

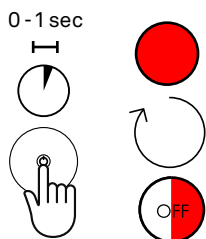

- 1) Quickly press the touch sensor to set the dimmer function to ON (permanent red LED) or OFF (flashing red LED)

- 2a) **SAVE AND CONTINUE TO STEP 4**  
Press lightly for 1-2 seconds until a flash appears
- 2b)\*

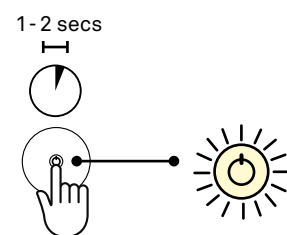

## STEP 4 - CALL TO TABLE (BLUE LED)

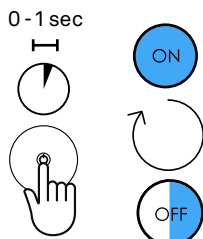

- 1) Quickly press the touch sensor to set the call to table function to ON (permanent blue LED) or OFF (flashing blue LED)

- 2a) **SAVE AND CONTINUE TO STEP 1**  
Press lightly for 1-2 seconds until a flash appears
- 2b)\*

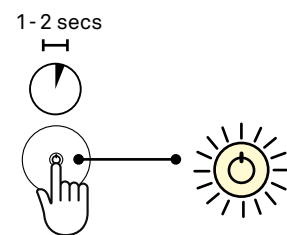



# resetting the settings

Restoring the manufacturer's setting

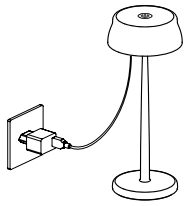

1

Plug the lamp into the electric socket

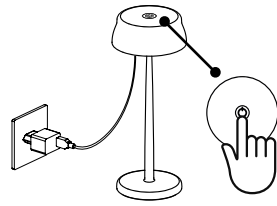

2

Place a finger on the touch sensor and keep it pressed down

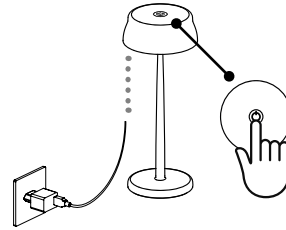

3

Unplug the lamp from the electric socket

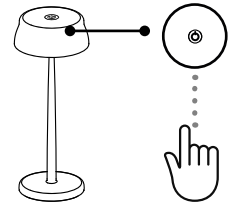

4

Remove your finger from the touch sensor

# assembly instructions

Magnetic fixing

INCLUDED

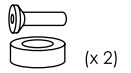

Magnetic fixing kit

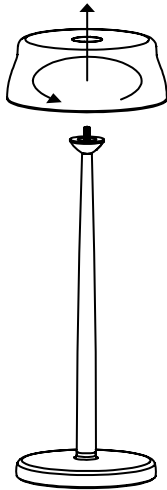

1

Unscrew the top of the lamp from the threaded pin

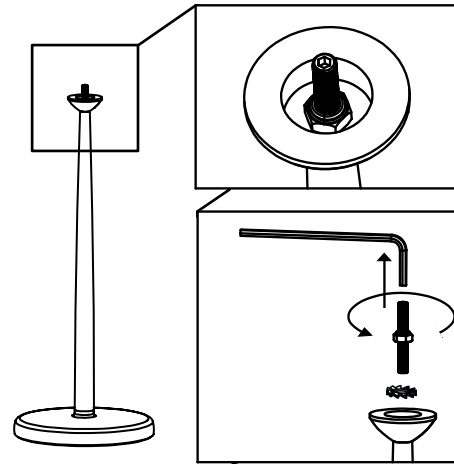

2

Unscrew the threaded pin

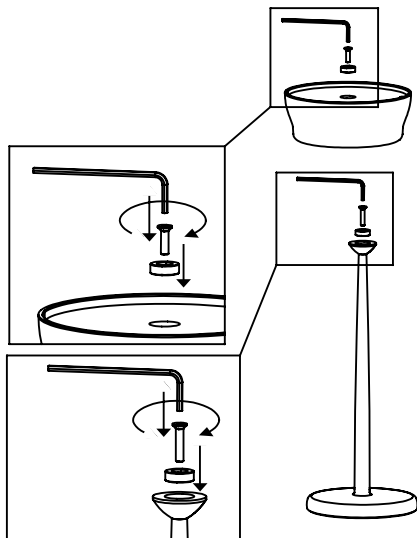

3

Screw the magnets

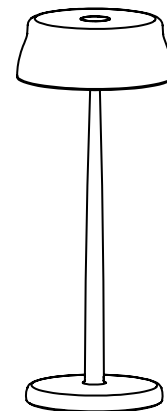

For more information and updates visit our website

NOT PRODUCED IN ITALY - IMPORTED BY

Zafferano srl, Viale dell'Industria, 26 - 31055 Quinto di Treviso - TV - Italy

www.zafferanoitalia.com

# sister light

AUFLADBARE TISCHLAMP

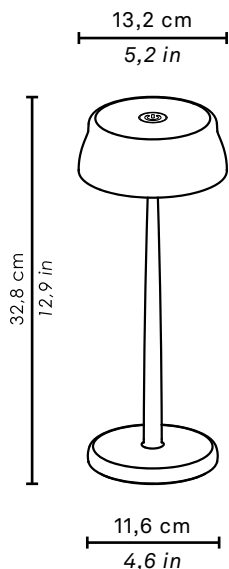

LED NICHT AUSTAUSCHBAR

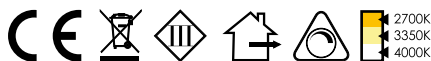

## LED DIMMER

3W • 250lm - 260lm - 270lm • 2700K  
- 3350K - 4000K • IP65 • 220-240V  
50-60Hz • CRI>90 • 5Vdc max 2A  
Ø 13,2 x h 32,8 x Ø 11,6 cm  
Ø 5,2 x h 12,9 x Ø 4,6 in

LD0300A3 eloxiertes Aluminium  
LD0300O3 eloxiertes Gold  
LD0300R3 eloxiertes Kupfer  
LD0300B3 eloxiertes Blau  
LD0300V3 eloxiertes Grün

\*Montageanleitungen finden Sie auf der Website

## Inbegriffen

USB-Ladekabel Typ C

x 2 Magnetbefestigungssatz

## Nicht enthalten

LD0300UC  
Ladegerät mit doppeltem USB-Eingang

LD0340RA  
Ladegerät (8xUSB)

LD0300KT  
Set für Befestigung am Tisch \*

BAT04705506701900  
Ersatzakku

## 1. Hinweise zur Verwendung:

Dieses Produkt dient ausschließlich zur Beleuchtung und:

**A)** Darf keinen starken mechanischen Belastungen oder starken Kontaminationen ausgesetzt werden; **B)** kann nur, nachdem der Zustand des Produkts kontrolliert wurde, installiert und verwendet werden; prüfen, dass es nicht schmutzig ist und während der Lagerung nicht beschädigt wurde; **C)** Das Gerät muss ausgeschaltet, installiert oder gewartet werden; **D)** Durch die Veränderung oder Manipulation des Produkts und die Nichteinhaltung dieser Anweisungen kann das Gerät gefährlich werden; **E)** Produkte mit Schutzgrad 65 (IP65) können im Freien verwendet werden; **F)** Zur Reinigung aller Metall- oder Plastikoberflächen ein trockenes, weiches Tuch verwenden; **G)** Die Firma Zafferano lehnt jede Verantwortung für Schäden ab, die durch eines ihrer Produkte, das nicht gemäß der gelieferten Anweisungen montiert wurde, entstehen.

## 2. Technische Daten:

- Leistung: 3 W
- Volt: DC 5 V
- Absoluter Lichtstrom: 2700K 148 lm - 3350K 158 lm - 4000K 166 lm
- LED: HONGLITRONIC 2835 / (8+42 pz) 3 STEP MAC ADAM
- Eine Lithiumbatterie ist in der Lieferung enthalten: 18650 / 7500mA/H\*3; zu den Anweisungen zum Auswechseln der Batterie schauen Sie bitte auf die Webseite [www.zafferanoitalia.com](http://www.zafferanoitalia.com). Die Batterie sollte nur durch eine Originalbatterie ersetzt werden.
- Standardaufladung: 1A - 2A (max 2,5A)
- Aufladezeit: 5 Std 2A - 10 Std 1A
- Batteriedauer: 100% 8 Std - 60% 13 Std - 30% 28 Std - 6% 58 Std
- Klasse: III
- Schutzgrad: IP65
- CRI≥90
- Unter Bezugnahme auf die Norm DIN EN ISO 9227 hat die Lampe bei der neutralen Salzsprühnebelprüfung (NSS) eine Korrosionsbeständigkeit von 1500 Stunden.

## 3. Ladegerät:

- Um das Produkt aufzuladen, können Aufladegeräte mit Mikro verwendet werden.
- Ladegerät mit doppeltem USB-Eingang NICHT ENTHALTEN: INPUT 100-240 V AC - 50/60Hz; OUTPUT DC 5V - 2.1 A.
- Um die Lampe korrekt aufzuladen, sollte man: 1- Das USB-Kabel an den Adapter anschließen; 2-Das USB-Kabel an die Lampe anschließen; 3-Den Stecker in die Steckdose stecken; 4- Wenn die Lampe aufgeladen ist, den Stecker aus der Steckdose ziehen und das USB-Kabel von der Lampe trennen.
- Die Lampe funktioniert auch mit Stromanschluss korrekt.
- Wir raten dazu, das optionale Ladegerät und das mitgelieferte Kabel zu verwenden. Als Alternative ein zertifiziertes 2A-Kabel und Ladegerät verwenden.

## 4. Werkskonfiguration:

HELLIGKEIT 100% - K 2700 - TISCHRUF AUS - DIMMER AN - MECHANISCHE BEFESTIGUNG

## 5. Achtung:

- Die Standfläche der Lampe darf keine höhere Neigung als 15° besitzen, sonst fällt diese um.
- Die Batterie ist abgesichert gegen: Kurzschluss, Überentlastung, Überbelastung, Überstrom, Überspannung.
- Um die Lebensdauer des Akkus zu erhalten, sollte sein Ladestand zwischen 20 und 80 Prozent liegen. Wenn die Lampe lange Zeit nicht benutzt wird, sollte der Akku regelmäßig ent- und wieder aufgeladen werden.
- Die Batterie muss entsprechend der geltenden, lokalen Vorschriften zur Abfallentsorgung und -wiederverwertung behandelt werden.

Zu weiteren Informationen und Aktualisierungen der Produktkennzeichen besuchen Sie bitte unsere Webseite.

NICHT IN ITALIEN PRODUZIERT - IMPORTIERT VON

Zafferano srl, Viale dell'Industria, 26 - 31055 Quinto di Treviso - TV - Italien

[www.zafferanoitalia.com](http://www.zafferanoitalia.com)



# gebrauchsanweisung

## WERKSKONFIGURATION

### EIN-/AUSSCHALTEN

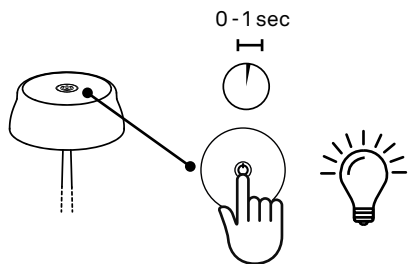

1

Die Taste kurz drücken und die Lampe geht an.

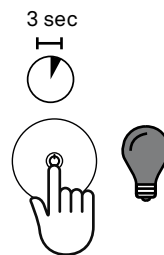

2

Die Taste 3 Sekunden lang drücken, die Lampe geht aus.

### LICHT DIMMEN

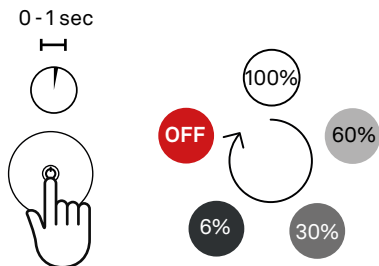

Wenn die Lampe an ist, kurz berühren, um die Helligkeit zu ändern. Die Wiederholung der Dimmstufen ist zyklisch.

### ANDERE KONFIGURATIONEN

#### TISCHRUF (WENN ON - Ebene 4 Konfigurationsmenü)

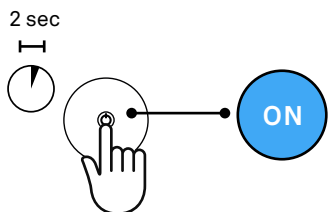

1

Wenn die Lampe an ist, 2 Sekunden lang drücken, um den Tischruf zu aktivieren.

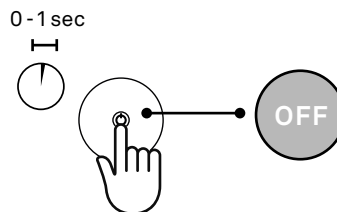

2

Kurz berühren, um den Tischruf zu deaktivieren.

#### EIN-/AUSSCHALTEN (WENN DIMMER UND TISCHRUF OFF - Ebene 3 und 4 Konfigurationsmenü)

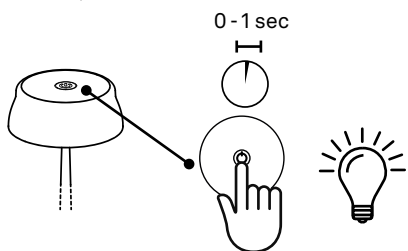

1

Die Taste kurz drücken und die Lampe geht an.

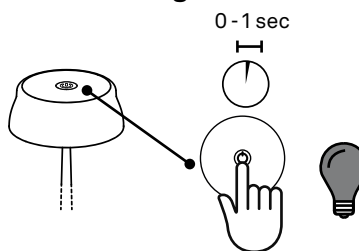

2

Die Taste kurz drücken und die Lampe geht aus.

### LEDANZEIGE

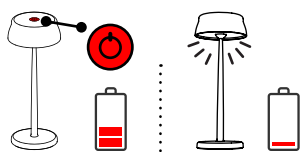

#### LED LEUCHTET ROT

Batterieladung unter 20%. Die Batterie sollte aufgeladen werden  
Wenn die Batterie entladen ist (1%), geht die Lampe nicht an, blinkt aber dreimal weiß auf - aufladen

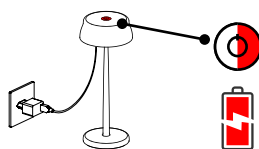

#### LED BLINKT ROT Wird aufgeladen

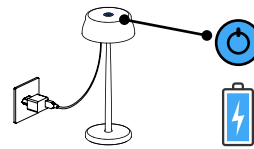

#### LED LEUCHTET BLAU Batterie zu 100% aufgeladen. Die Batterie vom Ladegerät trennen

Zu weiteren Informationen und Aktualisierungen der Produktkennzeichen besuchen Sie bitte unsere Webseite.

NICHT IN ITALIEN PRODUZIERT - IMPORTIERT VON

Zafferano srl, Viale dell'Industria, 26 - 31055 Quinto di Treviso - TV - Italien

[www.zafferanoitalia.com](http://www.zafferanoitalia.com)

# menü-konfiguration



Das Konfigurationsmenü besteht aus vier aufeinanderfolgenden Ebenen:

- 1) Einstellung der Ausgangshelligkeit
- 2) Einstellung der Farbtemperatur (dynamisches Weiß)
- 3) Dimmer AN - AUS
- 4) Tischruf AN - AUS

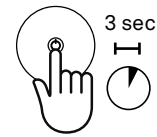
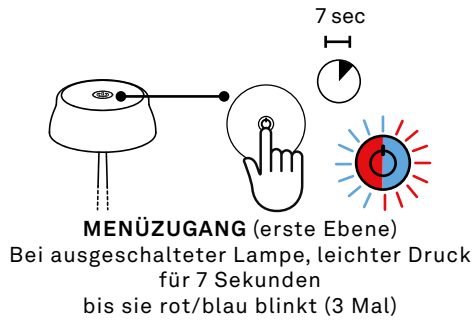

## 2b)\* SPEICHERN UND DAS MENÜ VERLASSEN

Von jedem Niveau aus, 3 Sekunden lang leicht drücken, damit die Lampe ausgeht

0-1 sec

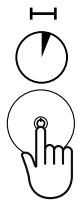

## EBENE 1 - AUSGANGSHELLIGKEIT

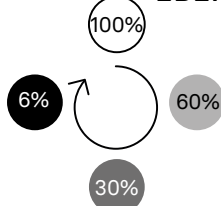

1-2 sec

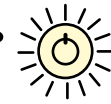

- 1) Kurz berühren, um die Helligkeit der Lampe zu verändern

- 2a) **SPEICHERN UND ZU EBENE 2 ÜBERGEHEN**  
1-2 Sekunden lang leicht drücken, bis sie aufleuchtet  
2b)\*

0-1 sec

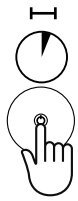

## EBENE 2 - FARBTEMPERATUR (K) (dynamisches Weiß)

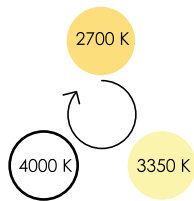

1-2 sec

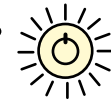

- 1) Kurz berühren, um die Farbtemperatur der Lampe zu verändern

- 2a) **SPEICHERN UND ZU EBENE 3 ÜBERGEHEN**  
1-2 Sekunden lang leicht drücken, bis sie aufleuchtet  
2b)\*

0-1 sec

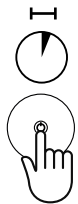

## EBENE 3 - DIMMER (LED ROT)



1-2 sec

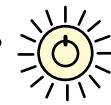

- 1) Kurz berühren, um den Dimmer auf AN (LED leuchtet rot) oder AUS (LED blinkt rot) zu stellen.

- 2a) **SPEICHERN UND ZU EBENE 4 ÜBERGEHEN**  
1-2 Sekunden lang leicht drücken, bis sie aufleuchtet  
2b)\*

0-1 sec



## EBENE 4 - TISCHRUF (LED BLAU)



1-2 sec

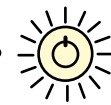

- 1) Kurz berühren, um den Tischruf auf AN (LED leuchtet blau) oder AUS (LED blinkt blau) zu stellen.

- 2a) **SPEICHERN UND ZU EBENE 1 ÜBERGEHEN**  
1-2 Sekunden lang leicht drücken, bis sie aufleuchtet  
2b)\*

Zu weiteren Informationen und Aktualisierungen der Produktkennzeichen besuchen Sie bitte unsere Webseite.

NICHT IN ITALIEN PRODUZIERT - IMPORTIERT VON

Zafferano srl, Viale dell'Industria, 26 - 31055 Quinto di Treviso - TV - Italien

[www.zafferanoitalia.com](http://www.zafferanoitalia.com)



# reset der einstellungen

Wiederherstellung der Werkskonfiguration

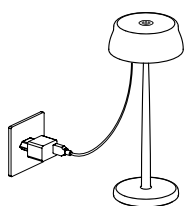

1

Den Stecker der Lampe in die Steckdose stecken

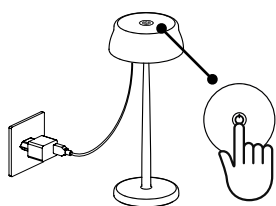

2

Mit dem Finger auf das Touchfeld drücken

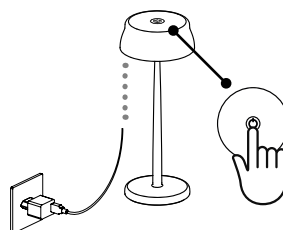

3

Den Stecker der Lampe aus der Steckdose ziehen

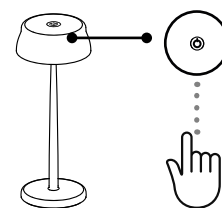

4

Den Finger vom Touchfeld nehmen

# montageanleitung

Magnetische Befestigung

INBEGRIFFEN



(x 2)

Magnetbefestigungssatz

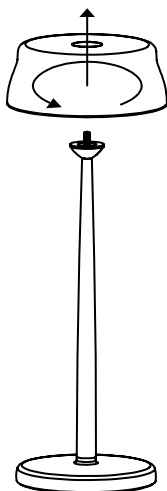

1

Den Lampenkopf vom Gewindestift schrauben

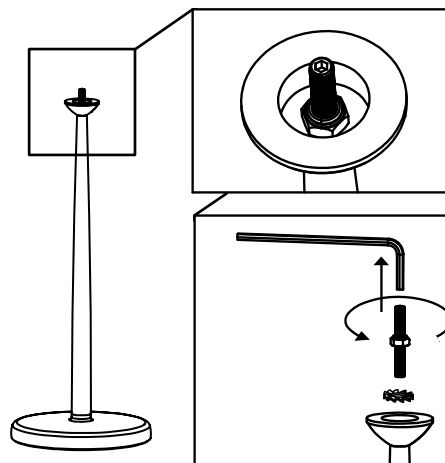

2

Den Gewindestift schrauben

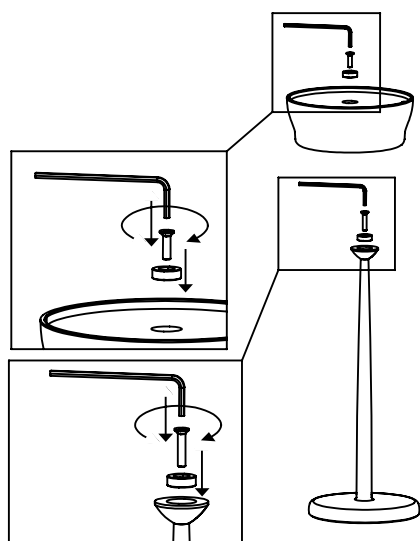

3

Magneten anschrauben

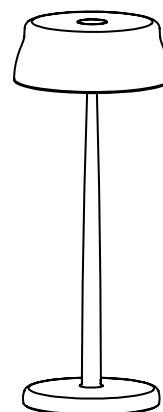

Zu weiteren Informationen und Aktualisierungen der Produktkennzeichen besuchen Sie bitte unsere Webseite.

NICHT IN ITALIEN PRODUZIERT - IMPORTIERT VON

Zafferano srl, Viale dell'Industria, 26 - 31055 Quinto di Treviso - TV - Italien

[www.zafferanoitalia.com](http://www.zafferanoitalia.com)

# sister light

lampe de table rechargeable

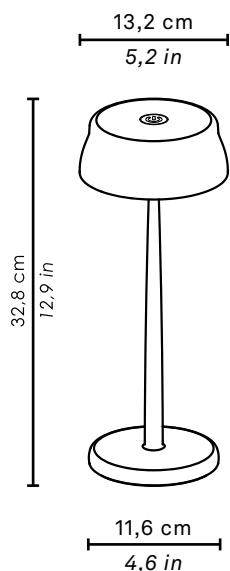

LED NON REMPLAÇABLE

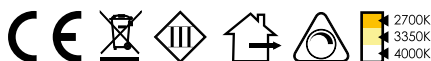

## LED DIMMER

3W • 250lm - 260lm - 270lm • 2700K  
- 3350K - 4000K • IP65 • 220-240V  
50-60Hz • CRI>90 • 5Vdc max 2A  
Ø 13,2 x h 32,8 x Ø 11,6 cm  
Ø 5,2 x h 12,9 x Ø 4,6 in

LD0300A3 aluminium anodisé  
LD0300O3 or anodisé  
LD0300R3 cuivre anodisé  
LD0300B3 bleu anodisé  
LD0300V3 vert anodisé

\* Les notice de montage  
sont disponibles sur le site web

## Inclus



Câble de recharge avec  
entrée USB type C



Kit pour fixation  
magnétique

## Non inclus



LD0300UC  
Chargeur de batteries à  
double entrée USB



LD0340RA  
Station de charge multiple  
(8xUSB)



LD0300KT  
Kit pour fixation à la table\*



BAT04705506701900  
Batterie de remplacement

## 1. Conseils d'utilisation:

Ce produit sert exclusivement pour éclairer et:

**A)** Ne doit pas être exposé à de lourdes charges mécaniques ou à de fortes contaminations; **B)** Peut être installé et utilisé uniquement après avoir contrôlé les conditions du produit; vérifier s'il n'est pas sale et s'il n'a pas subi de dommages durant le stockage; **C)** L'installation et l'entretien doivent être effectués lorsque l'appareil est éteint; **D)** Les modifications ou les altérations du produit et le non-respect des indications fournies peuvent rendre l'appareil dangereux; **E)** Les produits avec un degré de protection 65 (IP65) sont adaptés à une utilisation externe; **F)** Pour le nettoyage de toutes les surfaces métalliques et plastiques, utiliser un chiffon souple et sec; **G)** La société Zafferano décline toute responsabilité pour les dommages provoqués par un produit monté de manière non conforme par rapport aux instructions.

## 2. Données techniques:

- Puissance: 3 W
- Voltage: DC 5 V
- Flux lumineux: 2700K 250 lm - 3350K 260 lm - 4000K 270 lm
- LED: HONGLITRONIC 2835 / (8+42 pz) 3 STEP MAC ADAM
- Batteries au lithium inclus: 18650 / 7500mA/H\*3; visiter le site [www.zafferanoitalia.com](http://www.zafferanoitalia.com) pour avoir les indications de son remplacement. Pour le remplacement, il est recommandé l'usage d'un assemblage-batteries original.
- Standard recharge: 1A - 2A (max 2,5A)
- Recharge: 5 h 2A - 10 h 1A
- Durée de la batterie: 100% 8 h - 60% 13 h - 30% 28 h - 6% 58 h
- Classe: III
- Degré de protection: IP65
- CRI≥90
- Conformément à la norme UNI EN ISO 9227, la résistance de la lampe à l'exposition au brouillard salin neutre (NSS) est garantie pendant 1500 heures.

## 3. Chargeur de batterie:

- Pour recharger le produit, il est possible d'utiliser le chargeur de batterie USB standard A.
- Chargeur de batteries à double entrée USB - NON INCLUS: INPUT 100-240 V AC - 50/60Hz; OUTPUT DC 5V - 2.1 A.
- Pour recharger la lampe correctement, il est conseillé de: 1- brancher le câble USB à l'adaptateur; 2- brancher le câble USB à la lampe; 3- insérer la fiche dans la prise de courant; 4- lorsque la lampe est rechargée, retirer la fiche de la prise de courant et enlever le câble USB.
- La lampe fonctionne correctement, même si elle est raccordée au courant.
- Il est recommandé l'usage du chargeur optionnel et du câble original en dotation. Comme alternative, utiliser un câble et un chargeur certifiés à 2A.

## 4. Configuration d'usine:

LUMINOSITE 100% - K 2700 – APPEL À LA TABLE OFF - DIMMER ON – FIXATION MÉCANIQUE

## 5. Attention:

- Le plan d'appui de la lampe ne doit pas dépasser 15° d'inclinaison, sinon elle risque de tomber.
- La batterie est fournie avec les protections suivantes: court-circuit, sous-charge, surcharge, surintensité, surtension.
- Pour préserver l'intégrité de la batterie, il est conseillé de maintenir la charge entre 20% minimum et 80% maximum; si la lampe n'est pas utilisée pendant de longues périodes, il est conseillé de procéder périodiquement à un cycle de charge/décharge du produit.
- Se référer aux lois locales pour une élimination correcte et le recyclage de la batterie.

Visitez notre site pour recevoir d'autres informations et des mises à jour sur les caractéristiques du produit

NON FABRIQUE EN ITALIE - IMPORTE PAR

Zafferano srl, Viale dell'Industria, 26 - 31055 Quinto di Treviso - TV - Italie

[www.zafferanoitalia.com](http://www.zafferanoitalia.com)



# mode d'emploi

## CONFIGURATION D'USINE

### ALLUMAGE / COUPURE

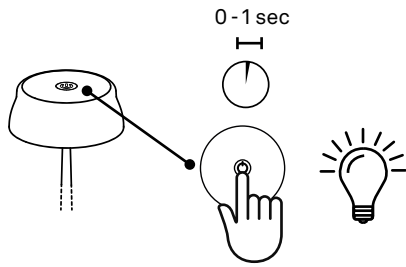

1 Toucher rapidement la fonction Touch pour allumer la lampe

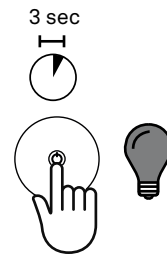

2 Pression légère pendant 3 secondes pour éteindre la lampe

### VARIATION DE L'INTENSITE LUMINEUSE

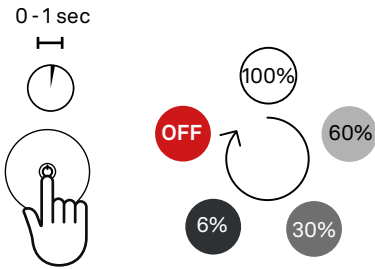

Lorsque la lampe est allumée, toucher rapidement pour changer la luminosité du dispositif. La répétition des phases de la variation de la lumière est cyclique.

### D'AUTRES CONFIGURATIONS

#### APPEL À LA TABLE (SI ON - niveau 4 configuration menu)

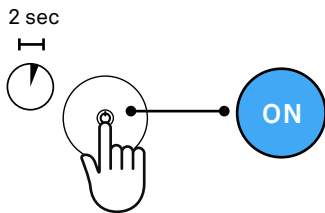

1 Lorsque la lampe est allumée, une légère pression pendant 2 secondes active l'appel à la table

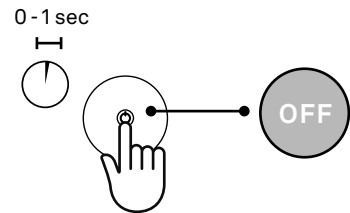

2 Toucher rapidement pour désactiver l'appel à la table

#### ALLUMAGE / COUPURE (SI DIMMER ET APPEL À LA TABLE OFF - niveau 3 et 4 configuration menu)

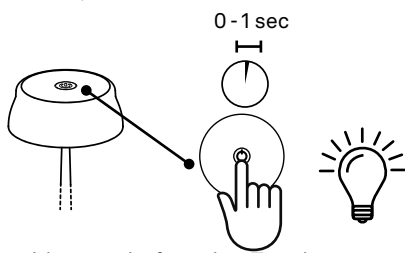

1 Toucher rapidement la fonction Touch pour allumer la lampe

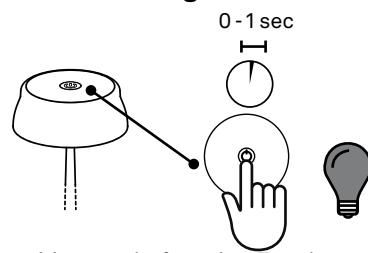

2 Toucher rapidement la fonction Touch pour éteindre la lampe

### LED DE SIGNALISATION

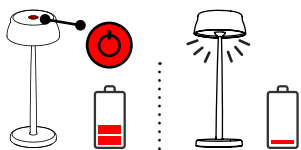

LED ROUGE FIXE: charge de la batterie inférieure à 20%, nous vous conseillons de la recharger. Lorsque la charge est épuisée (1%), la lampe ne s'allume pas, mais elle émet trois flashes blanc d'alarme - recharger

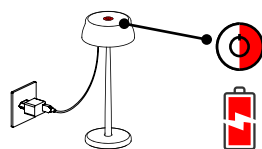

LED ROUGE CLIGNOTANTE recharge en cours

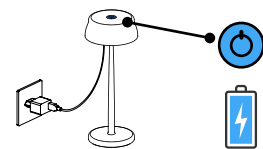

LED BLEUE FIXE: batterie rechargée à 100%, nous vous conseillons de la débrancher de l'unité de recharge

Visitez notre site pour recevoir d'autres informations et des mises à jour sur les caractéristiques du produit



# configuration menu



Le menu de configuration est composé de quatre niveaux consécutifs:

- 1) Réglage de la luminosité par défaut
- 2) Réglage de la température de couleur
- 3) Dimmer ON - OFF
- 4) Appel à la table ON - OFF

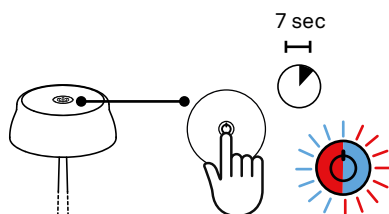

**POUR ACCEDER AU MENU (premier niveau)**  
Avec la lampe éteinte, pression légère pendant 7 secondes jusqu'à ce qu'elle clignote rouge/bleu (3 fois)

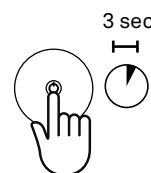

## 2b)\*MEMORISER ET SORTIR DU MENU

A partir de n'importe quel niveau, Pression légère pendant 3 secondes pour éteindre la lampe.

0-1 sec

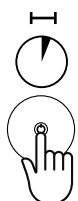

## NIVEAU 1 – LUMINOSITE PAR DEFAULT

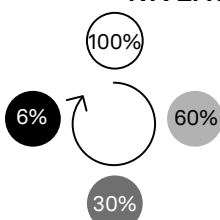

- 1) Toucher rapidement pour changer la luminosité de la lampe

1-2 sec

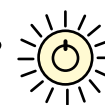
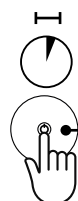

- 2a) MEMORISER ET PASSER AU NIVEAU 2: Pression légère pendant 1-2 secondes jusqu'à ce qu'un flash apparaisse
- 2b)\*

0-1 sec

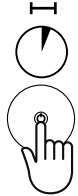

## NIVEAU 2 – TEMPERATURE DE COULEUR (blanc dynamique)

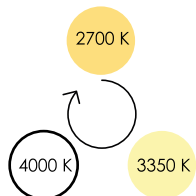

- 1) Toucher rapidement pour changer la température de couleur de la lampe

1-2 sec

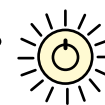

- 2a) MEMORISER ET PASSER AU NIVEAU 3: Pression légère pendant 1-2 secondes jusqu'à ce qu'un flash apparaisse
- 2b)\*

0-1 sec

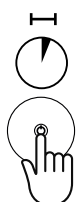

## NIVEAU 3 - DIMMER (LED ROUGE)



- 1) Toucher rapidement pour régler le dimmer ON (LED rouge fixe) ou OFF (LED rouge clignotante)

1-2 sec

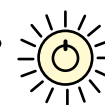
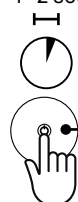

- 2a) MEMORISER ET PASSER AU NIVEAU 4: Pression légère pendant 1-2 secondes jusqu'à ce qu'un flash apparaisse
- 2b)\*

0-1 sec

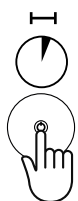

## NIVEAU 4 – APPEL A LA TABLE (LED BLEUE)

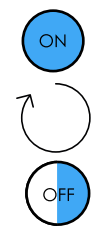

- 1) Toucher rapidement pour régler l'appel à la table ON (LED bleue fixe) ou OFF (LED bleue clignotante)

1-2 sec

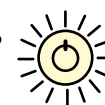
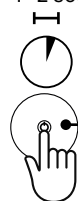

- 2a) MEMORISER ET PASSER AU NIVEAU 1: Pression légère pendant 1-2 secondes jusqu'à ce qu'un flash apparaisse
- 2b)\*

Visitez notre site pour recevoir d'autres informations et des mises à jour sur les caractéristiques du produit



# réinstallation des paramètres

Rétablissement de la configuration d'usine

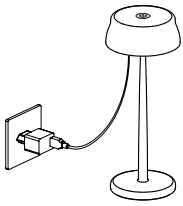

1

Connecter la lampe à la prise de courant

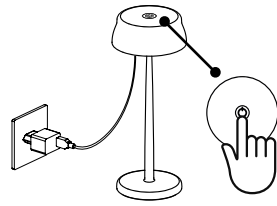

2

Toucher la fonctionne Touch en maintenant la pression

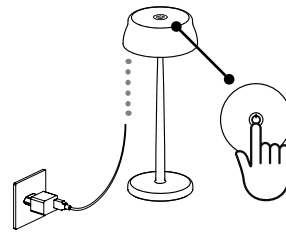

3

Débrancher la lampe da la prise de courant

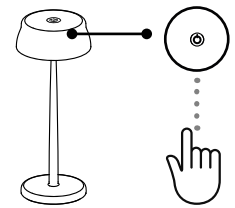

4

Lever le doigt de la fonctionne Touch

## notice de montage

Fixation magnétique

INCLUS

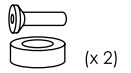

Kit pour fixation magnétique

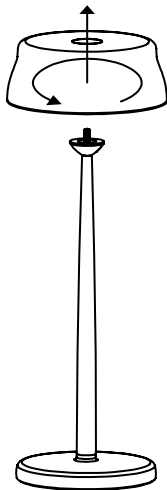

1

Dévisser la tête de lampe de la tige filetée

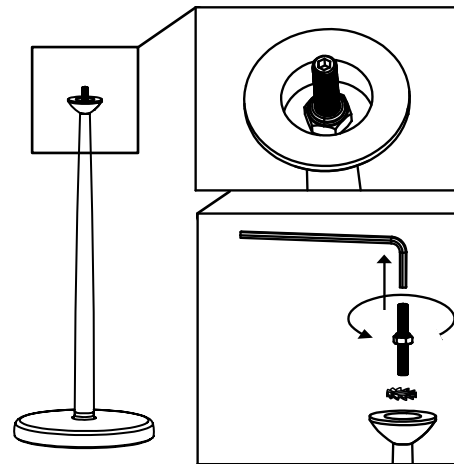

2

Dévisser la tige filetée

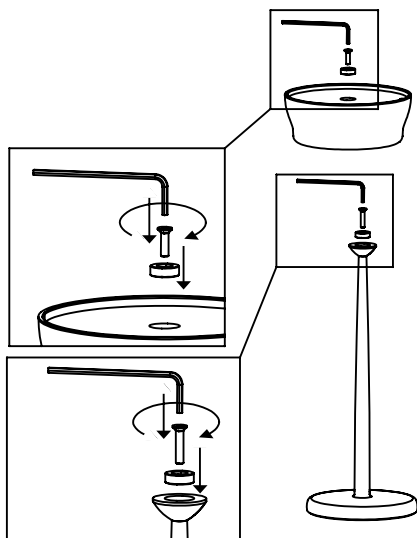

3

Visser les aimants

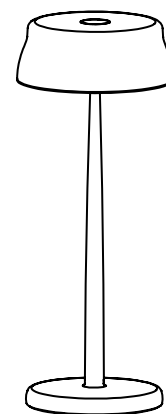

Visitez notre site pour recevoir d'autres informations et des mises à jour sur les caractéristiques du produit

NON FABRIQUE EN ITALIE - IMPORTE PAR

Zafferano srl, Viale dell'Industria, 26 - 31055 Quinto di Treviso - TV - Italie  
www.zafferanoitalia.com

# sister light

lámpara de mesa recargable

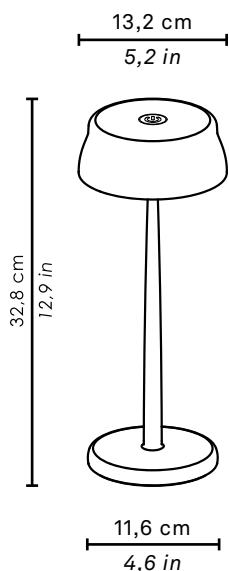

LED NO REEMPLAZABLE



## LED DIMMER

3W • 250lm - 260lm - 270lm • 2700K  
- 3350K - 4000K • IP65 • 220-240V  
50-60Hz • CRI>90 • 5Vdc max 2A  
Ø 13,2 x h 32,8 x Ø 11,6 cm  
Ø 5,2 x h 12,9 x Ø 4,6 in

LD0300A3 aluminio anodizado  
LD0300O3 oro anodizado  
LD0300R3 cobre anodizado  
LD0300B3 azul anodizado  
LD0300V3 verde anodizado

\* para instrucciones de montaje visitar el sitio web

## Incluido

Cable de recarga con entrada USB Tipo C

x 2 kit para fijación magnética

## No incluido

LD0300UC Cargador de batería con doble entrada USB

LD0340RA Cargador múltiple USB (8xUSB)

LD0300KT Kit de fijación para mesa\*

BAT04705506701900 Paquete batería sustitutiva

## 1. Consejos de uso:

Este producto debe utilizarse exclusivamente para iluminación y:

**A)** No debe ser expuesto a cargas mecánicas pesadas o contaminaciones fuertes; **B)** solo puede ser instalado y utilizado previo control de las condiciones del producto; verificar que no resulte estar sucio y no ha haya sido dañado durante el almacenamiento; **C)** la instalación y el mantenimiento deben realizarse con el aparato apagado; **D)** las modificaciones o las manipulaciones del producto y el incumplimiento de las indicaciones mostradas pueden hacer que el aparato sea peligroso; **E)** los productos con grado de protección 65 (IP65) son adecuados para uso externo; **F)** para la limpieza de todas las superficies metálicas y de plástico utilizar un paño suave y seco; **G)** La empresa Zafferano declina cualquier responsabilidad por los daños causados por un producto suyo montado de manera no conforme con las instrucciones.

## 2. Datos técnicos:

- Potencia: 3 W
- Voltios: DC 5 V
- Flujo luminoso: 2700K 250 lm - 3350K 260 lm - 4000K 270 lm
- LED: HONGLITRONIC 2835 /(8+42 pz) 3 STEP MAC ADAM
- Batería de litio incluida: 18650 / 7500mA/H\*3; para las instrucciones de sustitución de la batería consulte el sitio web [www.zafferanoitalia.com](http://www.zafferanoitalia.com). Para la sustitución se recomienda el uso de una batería original.
- Recarga standard: 1A - 2A (max 2,5A)
- Recarga: 5 h 2A - 10 h 1A
- Duración de la batería: 100% 8 h - 60% 13 h - 30% 28 h - 6% 58 h
- Clase: III
- Grado de protección: IP65
- CRI≥90
- En referencia a la norma UNI EN ISO 9227, la resistencia de la lampada a la exposición con niebla salina neutra (NSS) está garantizada durante 1500 horas.

## 3. Cargador de baterías:

- Para cargar el producto es posible usar el cargador de baterías USB estándar A.
- Cargador de batería con doble entrada USB – NO INCLUIDO: INPUT 100-240 V AC - 50/60Hz; OUTPUT DC 5V - 2.1 A.
- Para una carga correcta de la lámpara se aconseja: 1- conecte el cable USB al adaptador; 2- conecte el cable USB a la lámpara; 3- conecte el enchufe a la toma de corriente; 4- una vez completada la carga, retire el enchufe de la toma eléctrica y retire el cable USB.
- La lámpara funciona correctamente, aunque esté conectada a la corriente.
- Se aconseja el uso del cargador opcional y del cable en dotación original. Como alternativa, utilizar un cable y cargador de 2A certificados.

## 4. Configuración de fábrica:

- BRILLO 100% - K 2700 - LLAMADA A LA MESA OFF - OSCURECEDOR ON - FIJACIÓN MECÁNICA

## 5. Atención:

- La superficie de apoyo de la lámpara no debe superar los 15° de inclinación para evitar su caída.
- La batería se entrega con las siguientes protecciones: cortocircuito, sobredescarga, sobrecarga, sobrecorriente, sobretensión.
- Para preservar la integridad de la batería se aconseja mantener la carga entre un mínimo del 20% y un máximo del 80%; si la lámpara no se utiliza durante períodos prolongados se aconseja realizar periódicamente un ciclo de carga/descarga del producto.
- Remítase a las normativas de ley locales para una eliminación y reciclaje correctos de la batería.

Visite nuestro sitio web para más informaciones y actualizaciones sobre las características del producto

NO FABRICADO EN ITALIA - IMPORTADO POR

Zafferano srl, Viale dell'Industria, 26 - 31055 Quinto di Treviso - tv - Italia

[www.zafferanoitalia.com](http://www.zafferanoitalia.com)



# instrucciones de uso

## CONFIGURACIÓN DE FÁBRICA

### ENCENDIDO/ APAGADO

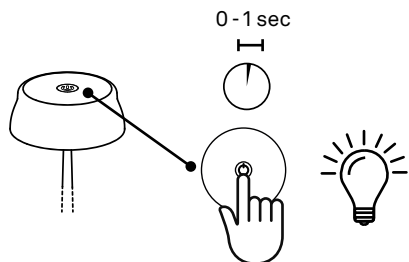

Toque rápido en la pantalla táctil para encender la lámpara

1

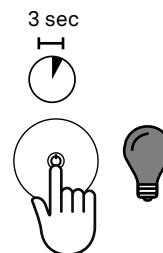

Ligera presión durante 3 segundos para apagar la lámpara

2

### OSCURECIMIENTO

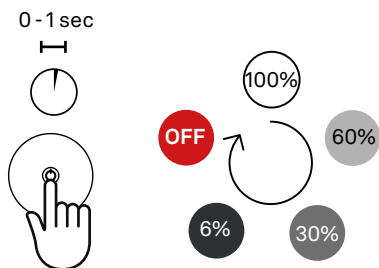

Con la lámpara encendida, toque rápido para cambiar el brillo del dispositivo. La repetición de las fases de la variación de la luz es cíclica.

### OTRAS CONFIGURACIONES

#### LLAMADA A LA MESA (SE ON - nivel 4 configuración menú)

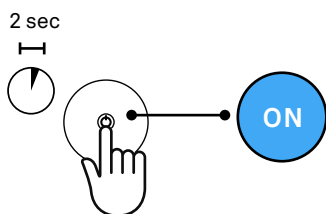

Con la lámpara encendida, ligera presión durante 2 segundos para activar la llamada a la mesa

1

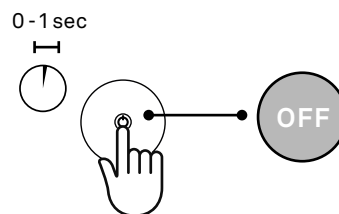

Toque rápido para desactivar la llamada a la mesa

2

#### ENCENDIDO/ APAGADO (SE DIMMER Y LLAMADA A LA MESA OFF - nivel 3 y 4 configuración menú)

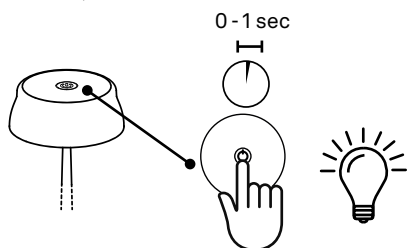

Toque rápido en la pantalla táctil para encender la lámpara

1

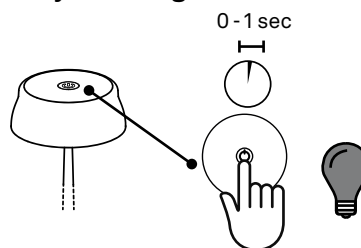

Toque rápido en la pantalla táctil para apagar la lámpara

2

### LED DE SEÑALIZACIÓN

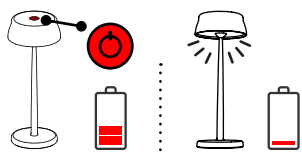

**LED ROJO FIJO** carga de la batería inferior al 20%, se recomienda recargar. Cuando la carga está agotada (1%), la lámpara no se enciende, sino que emite tres destellos blancos de alerta - recargar

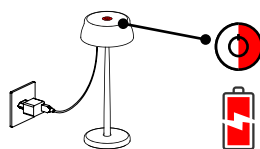

**LED ROJO INTERMITENTE** recarga en curso

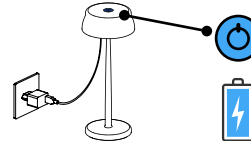

**LED AZUL FIJO** batería cargada al 100%, es aconsejable desconectar de la unidad de recarga

Visite nuestro sitio web para más informaciones y actualizaciones sobre las características del producto

NO FABRICADO EN ITALIA - IMPORTADO POR

Zafferano srl, Viale dell'Industria, 26 - 31055 Quinto di Treviso - tv - Italia

[www.zafferanoitalia.com](http://www.zafferanoitalia.com)

# configuración menú



El menú de configuración está formado por cuatro niveles consecutivos:

- 1) Configuración del brillo por defecto
- 2) Configuración de la temperatura de color
- 3) Oscurecimiento ON - OFF
- 4) Llamada a la mesa ON - OFF

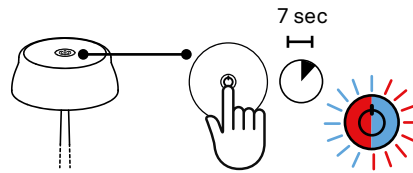

**PARA ACCEDER AL MENÚ** (primer nivel)  
Con lámpara apagada, ligera presión durante 7 segundos hasta que no parpadee de color rojo/azul (durante 3 vueltas)

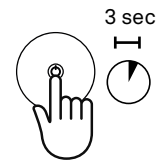

**2b)\* GUARDAR Y SALIR DEL MENÚ**  
Desde cualquier nivel, ligera presión durante 3 segundos para apagar la lámpara

0-1 sec

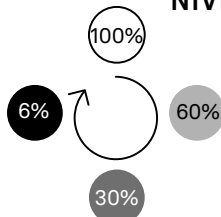
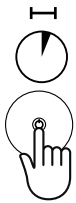

## NIVEL 1 - BRILLO POR DEFECTO

1-2 sec

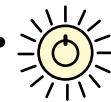

- 1) Toque rápido para cambiar el brillo de la lámpara

- 2) **GUARDAR Y PASAR AL NIVEL 2**  
Ligera presión durante 1-2 segundos hasta que aparezca un destello  
**2b)\***

0-1 sec

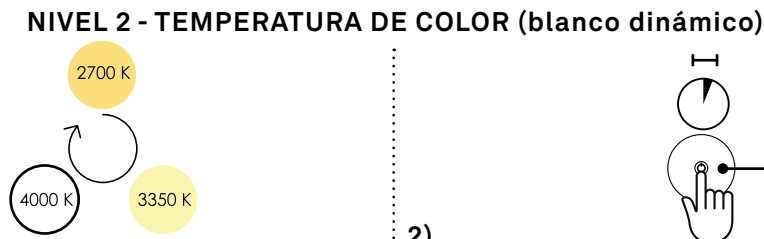
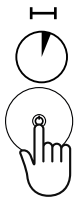

## NIVEL 2 - TEMPERATURA DE COLOR (blanco dinámico)



- 1) Toque rápido para cambiar la temperatura de color de la lámpara

- 2) **GUARDAR Y PASAR AL NIVEL 3**  
Ligera presión durante 1-2 segundos hasta que aparezca un destello  
**2b)\***

0-1 sec

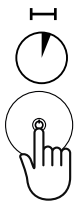

## NIVEL 3 - OSCURECIMIENTO (LED ROJO)

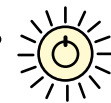

- 1) Toque rápido para configurar el oscurecedor ON (LED rojo fijo) u OFF (LED rojo intermitente)

- 2) **GUARDAR Y PASAR AL NIVEL 4**  
Ligera presión durante 1-2 segundos hasta que aparezca un destello  
**2b)\***

0-1 sec

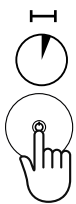

## LIVELLO 4 - CHIAMATA AL TAVOLO (LED BLU)

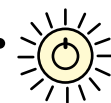

- 1) Toque rápido para configurar la llamada a la mesa ON (LED azul fijo) u OFF (LED azul intermitente)

- 2) **GUARDAR Y PASAR AL NIVEL 1**  
Ligera presión durante 1-2 segundos hasta que aparezca un destello  
**2b)\***

Visite nuestro sitio web para más informaciones y actualizaciones sobre las características del producto

NO FABRICADO EN ITALIA - IMPORTADO POR

Zafferano srl, Viale dell'Industria, 26 - 31055 Quinto di Treviso - tv - Italia

[www.zafferanoitalia.com](http://www.zafferanoitalia.com)



# restablecimiento de las configuraciones

Restablecimiento de la configuración de fábrica

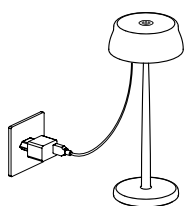

1

Conectar la lámpara a la toma de corriente

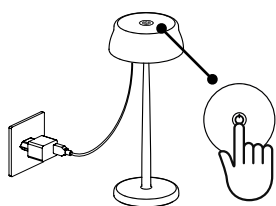

2

Apoyar el dedo en el elemento táctil manteniendo la presión

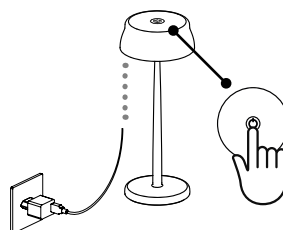

3

Desconectar la lámpara de la toma de corriente

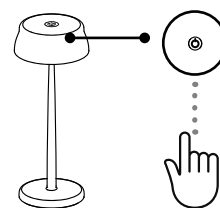

4

Levantar el dedo del elemento táctil

## instrucciones de montaje

Fijación magnética

INCLUIDO



kit para fijación magnética

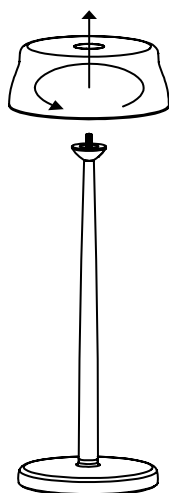

1

Desatornillar el cabezal de la lámpara del pasador roscado

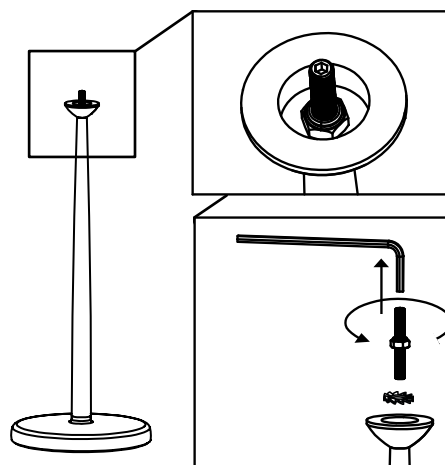

2

Desatornillar el perno roscado

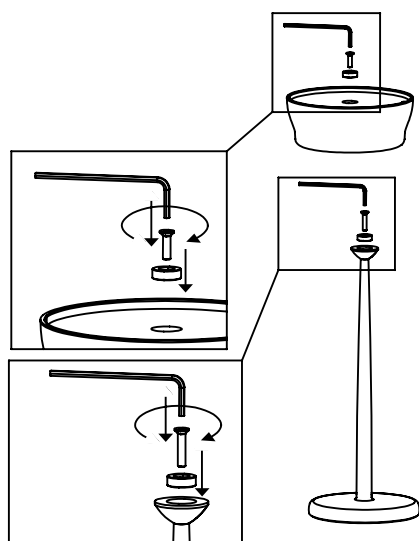

3

Atornillar los imanes

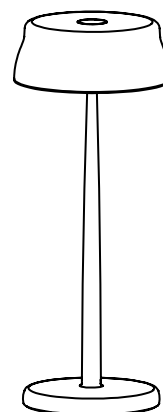

Visite nuestro sitio web para más informaciones y actualizaciones sobre las características del producto

NO FABRICADO EN ITALIA - IMPORTADO POR

Zafferano srl, Viale dell'Industria, 26 - 31055 Quinto di Treviso - tv - Italia

www.zafferanoitalia.com



zafferano

LAMPES A PORTER



**Zafferano srl**

Viale dell'Industria, 26  
31055 - Quinto di Treviso - Italia  
T +39 0422 470507  
F +39 0422 470400  
[lighting@zafferanoitalia.com](mailto:lighting@zafferanoitalia.com)

C.F 03420190260 - P.IVA IT 03305480273  
REA di TV n. 330102

[www.zafferanoitalia.com](http://www.zafferanoitalia.com)