

# ASSEMBLY INSTRUCTIONS

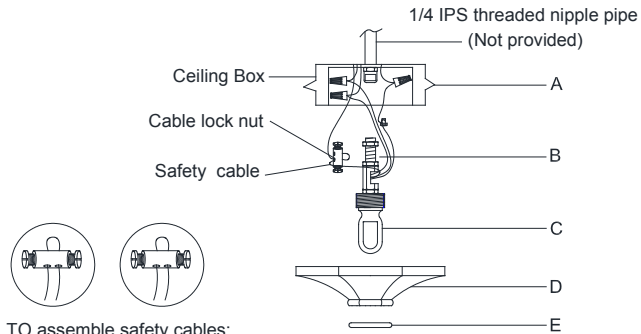

- TO assemble safety cables:
1. Join fixture safety cables with safety cable from ceiling.
  2. Wrap both safety cable around the cable lock nut.
  3. Insert screws into both holes on cable lock nut, secure screws with screwdriver.
  4. Push the cable lock nut into outlet box.

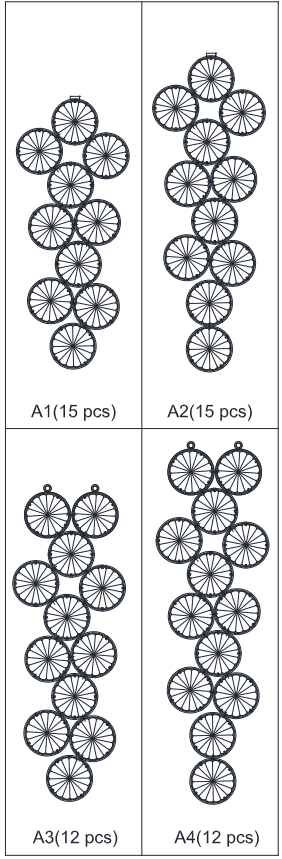
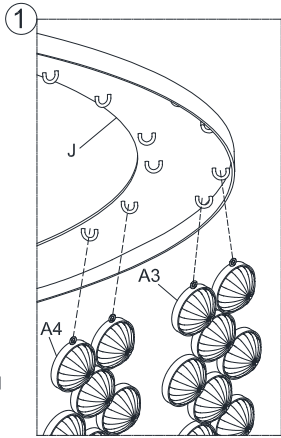
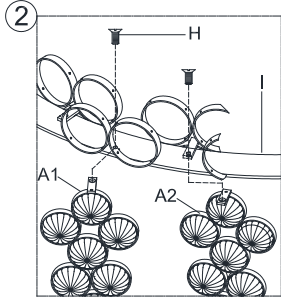
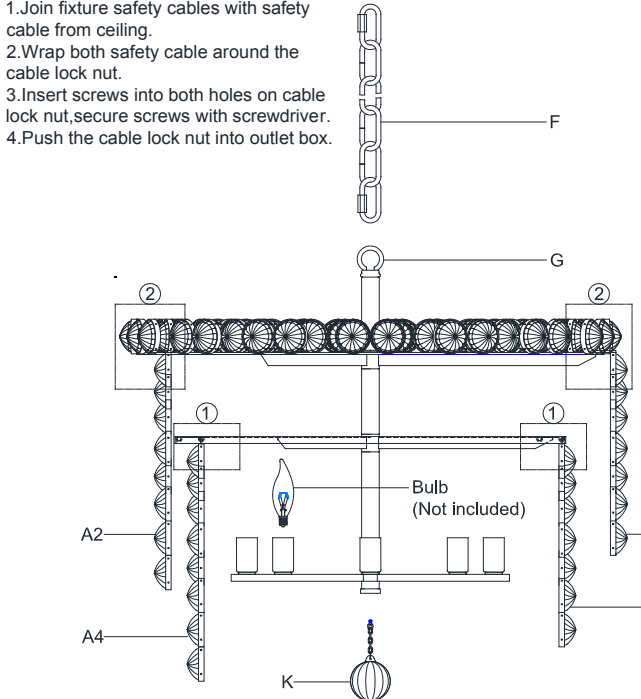

# Milazzo Medium Waterfall Chandelier

Item # JN 5234

WE RECOMMEND INSTALLATION OF THIS LIGHTING FIXTURE BE DONE BY A LICENSED ELECTRICIAN.

WARNING\*\*\*SWITCH OFF THE MAIN ELECTRICAL SUPPLY FROM THE MAIN FUSE BOX/CIRCUIT BREAKER BEFORE INSTALLATION.

INSPECT ITEM CAREFULLY BEFORE ATTEMPTING TO INSTALL. IF THERE IS ANY DAMAGE OR OBVIOUS DEFECT. DO NOT INSTALL.

ITEM MAY NOT BE RETURNED ONCE IT HAS BEEN INSTALLED.

NOTE: CAREFULLY UNPACK EACH PIECE IN TOP LAYER OF PACKING PRIOR TO REMOVING. RETAIN ALL PACKING MATERIAL UNTIL INSPECTION AND INSTALLATION ARE FINAL.

1. Carefully remove all parts from the box.
2. Provide a 1/4" IPS pipe with one end securely mounted to a beam or a structural member. The other end should protrude through the center of the outlet box as shown.
3. Install the threaded nipple (B) into the support pipe and adjust overall length to allow the canopy ring to hold the canopy flush to the ceiling.
4. With the fixture desired height, shorten the chain (F) as needed using a pair of chain pliers.
5. Open one chain quick link, then attach the chain quick link to the top ring (G). Secure the chain quick link.
6. Let collar ring (E) and canopy (D) go through the chain (F).
7. Open another chain quick link, then attach the chain quick link to the ceiling loop (C). Secure the chain quick link.
8. Weave the power supply cord and the ground wire through the chain (F).
9. Feed the fixture wire and ground wire through the ceiling loop (C) and pull until taut. Measure the wires then cut. Be certain to leave enough length to connect inside of the ceiling junction box.
10. Strip the insulation back on the two power supply wires about 5/8".
11. Twist the power supply and ground wire together and push through the center hole of the ceiling loop (C).



# ASSEMBLY INSTRUCTIONS

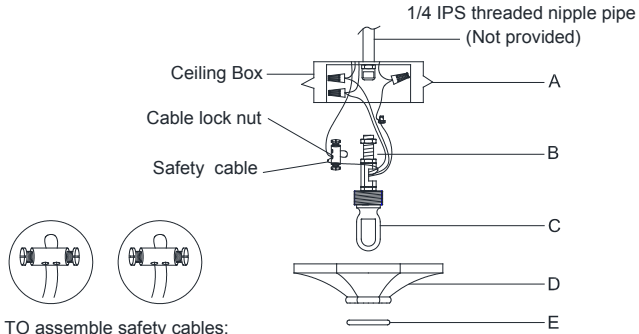

TO assemble safety cables:

1. Join fixture safety cables with safety cable from ceiling.
2. Wrap both safety cable around the cable lock nut.
3. Insert screws into both holes on cable lock nut, secure screws with screwdriver.
4. Push the cable lock nut into outlet box.

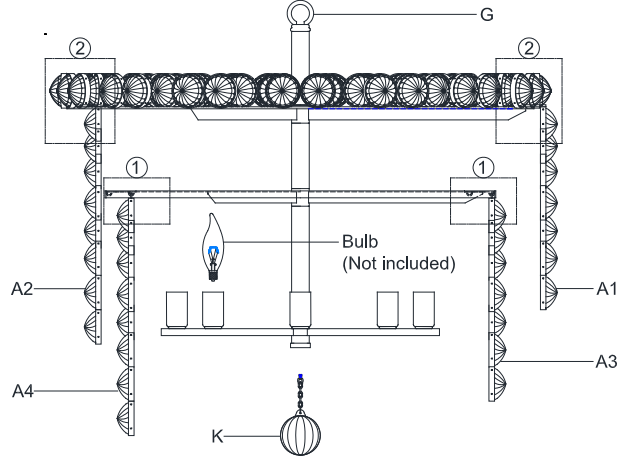
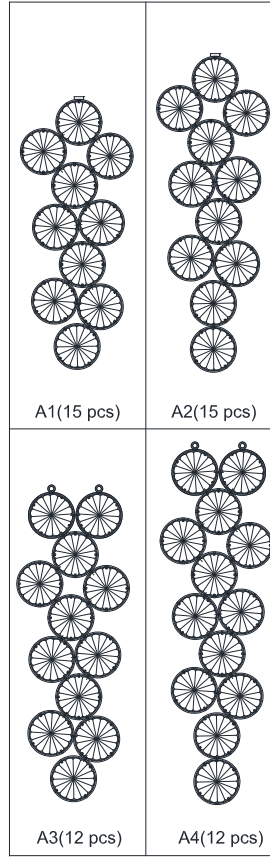
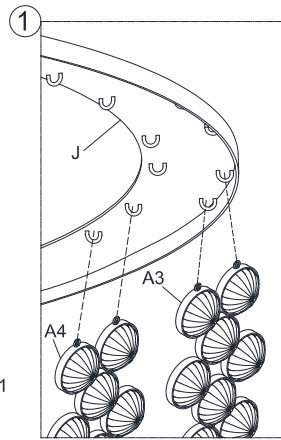
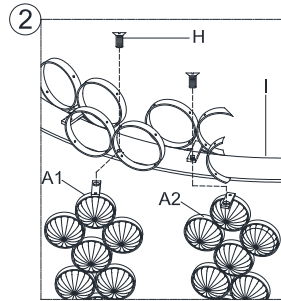

## Milazzo Medium Waterfall Chandelier

Item # JN 5234

WE RECOMMEND INSTALLATION OF THIS LIGHTING FIXTURE BE DONE BY A LICENSED ELECTRICIAN.

**WARNING\*\*\*SWITCH OFF THE MAIN ELECTRICAL SUPPLY FROM THE MAIN FUSE BOX/CIRCUIT BREAKER BEFORE INSTALLATION. INSPECT ITEM CAREFULLY BEFORE ATTEMPTING TO INSTALL. IF THERE IS ANY DAMAGE OR OBVIOUS DEFECT. DO NOT INSTALL.**

**ITEM MAY NOT BE RETURNED ONCE IT HAS BEEN INSTALLED.**

**NOTE: CAREFULLY UNPACK EACH PIECE IN TOP LAYER OF PACKING PRIOR TO REMOVING. RETAIN ALL PACKING MATERIAL UNTIL INSPECTION AND INSTALLATION ARE FINAL.**

12. Connect the fixture ground (bare) wire with the ground wire from the outlet box using wire nut (A). If your house does not have ground wire, then attach this wire to the green grounding screw inside of the outlet box. IT IS IMPERATIVE THAT THIS FIXTURE BE GROUNDED.
13. Connect the fixture Neutral wire (ribbed) with the neutral wire (White) from the outlet box using wire nut (A).
14. Connect the fixture Hot (smooth, marks with words) wire with the hot wire (Black) from the outlet box using wire nut (A). DO NOT REVERSE THE HOT AND NEUTRAL CONNECTIONS OR SAFETY WILL BE COMPROMISED.
15. Tuck these wire connections neatly into the outlet box to secure.
16. Put canopy (D) flush to the ceiling, and secure with collar ring (E).
17. Insert bulbs (not included) into the sockets.
18. Thread the glass drop (K) to the bottom of the fixture body.
19. Attach glass drops (A2) to the inner holes on the metal ring (I) and secure with screws (H).
20. Attach glass drops (A1) to the outer holes on the metal ring (I) and secure with screws (H).
21. Hang glass drops (A4) to the inner hooks on the metal ring (J).
22. Hang glass drops (A3) to the outer hooks on the metal ring (J).
23. Installation is complete, turn on power at fuse or circuit breaker.

\*\*\*Clean with a dry, soft cloth only. Use no harsh abrasives or chemical agents.

