

## Instructions

# VP1 & VP10 Canopy 31 &Tradition 2024



---

Please read these instructions carefully and retain them for future reference to ensure the product is used correctly. For your own safety, please study each step of this instruction manual first. &Tradition is not responsible for any faults or damage caused by not following these instructions correctly. Do not modify this product in any way. If you have any questions or comments, please do not hesitate to contact us by mail on: [info@andtradition.com](mailto:info@andtradition.com)

**&Tradition<sup>®</sup>**

# Canopy 31 &Tradition 2024

---

## Safety precautions

- Dispose the packaging and do not allow children to play with it.
- The canopy is only intended for interior use.
- If the cables or cords is damaged, it must be replaced by the manufacturer or a similarly qualified person to avoid any potential hazards.
- Consult a professionally qualified electrician if in any doubt.
- Keep the product well out of reach of children.

## Contents

- A Ceiling Bracket
- B Canopy
- C Screws

## Tools needed

- Screwdriver

## Cleaning instructions

- Wipe surface with a dry cloth.
- Do not use any abrasive cleaning tools such as steel wool, scouring sponges or stiff brushes.
- Never use strong cleaning agents such as white spirit, turpentine, household glass cleaner or cellulose thinners.

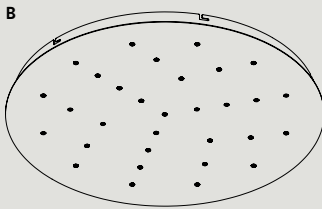
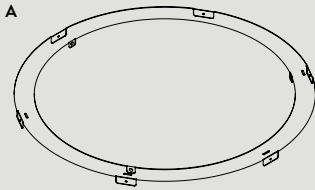

10/23

For indoor use only



&Tradition®

### Suggested placement for VP1

We recommend hanging the pendants layers for the VP1 with either 27,5 cm to achieve the visual expression on the left and or 16 cm to achieve the visual expression on the right.

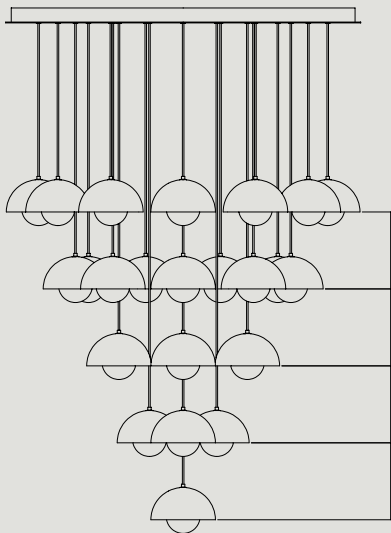

### Suggested placement for VP10

We recommend hanging the pendants layers for the VP10 with 19 cm to achieve the visual expression for both versions as seen below.

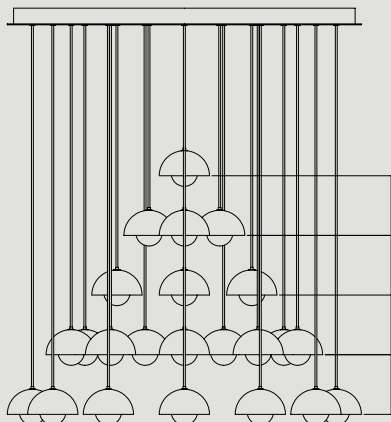
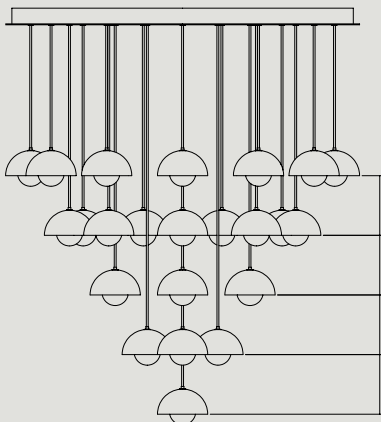

**Please follow steps 1-6 to assemble the product.**

### **Step 1 / 6**

---

Place the ceiling bracket in the desired location. Mark the placement of the holes with a pencil.

Drill holes for the ceiling bracket and use the correct type of screws and plugs for the type of ceiling, on which the canopy is to be installed.

Tighten the screws and ensure the ceiling bracket is safely fixed.

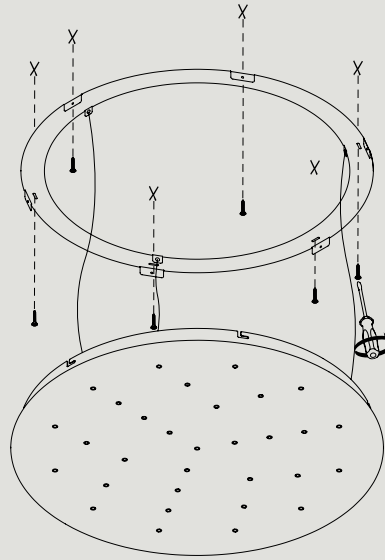

### **Step 2 / 6**

---

Now you can let go of the canopy. The wires will carry the weight.

Then pull the cords through the strain reliefs. Adjust the cord lengths and tighten the strain reliefs (clockwise) to lock the cord in place.

Install the wires from the cord to the terminal connectors by pressing down the button.

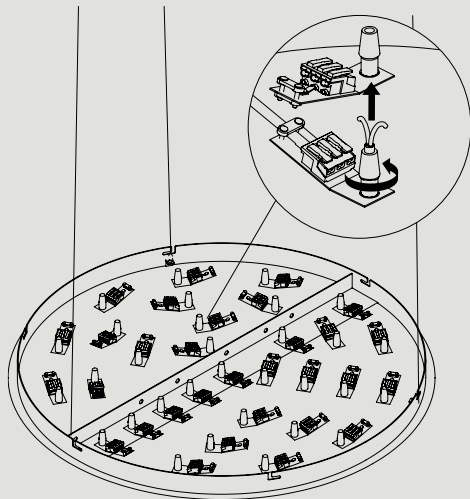

### Step 3 / 6

---

Now you can connect the canopy to the powercord in the ceiling.

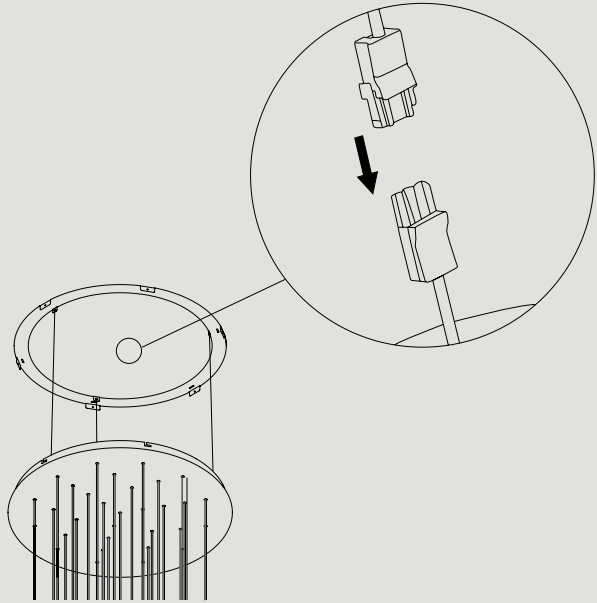

### Step 4 / 6

---

Lift the canopy including pendants up to the hinges.

Make sure the wires are placed inside the canopy.

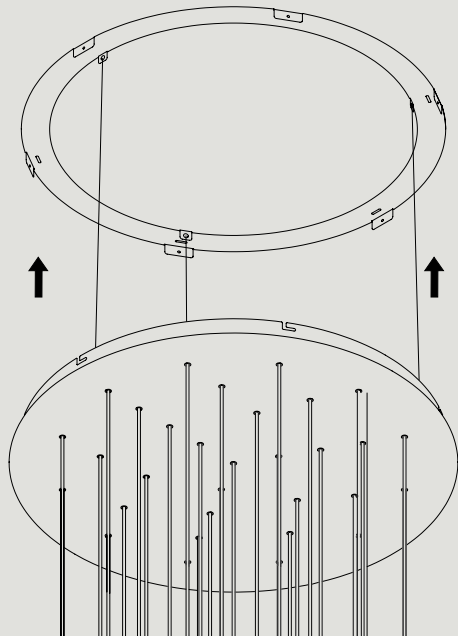

### Step 5 / 6

---

Placed the canopy onto the ceiling bracket in the L-slot and turn it.

The pre mounted screws will help guide you.

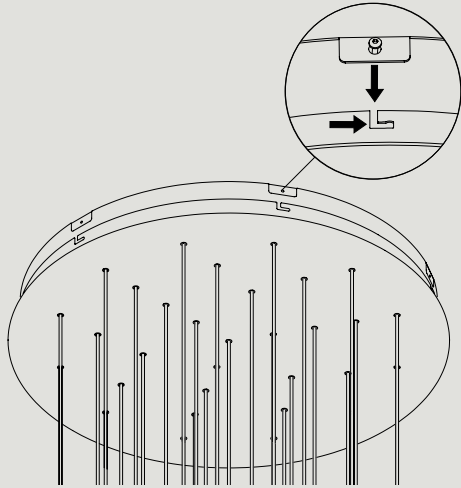

### Step 6 / 6

---

Tighten and secure the screw and make sure the canopy is proper fastened onto the ceiling bracket.

