

# INSTALLATION INSTRUCTIONS

For RLM (Rev. 11/27/2019)

## READ AND SAVE THESE INSTRUCTIONS

**WARNING! SHUT POWER OFF AT FUSE OR CIRCUIT BREAKER.**

**AVERTISSEMENT! COUPER LE COURANT AU NIVEAU DES FUSIBLES OU DU DISJONCTEUR.**

### MOUNTING THE FIXTURE (Fig.1)

1. Shut off power at the fuse box or circuit breaker box and remove the old fixture including the mounting hardware.
2. Carefully unpack your new fixture and lay out all the parts in a clear area. Take care not to misplace any small parts necessary for installation.
3. Position the mounting plate (B) on the wall, and mark location of the two plastic anchors (A). Drill the holes on the wall, and then insert the plastic anchors (A).
4. Attach the mounting plate (B) to the junction box using mounting screws (C) (Size: #8-32N\*L0.5"). The side of the mounting plate (B) marked "GND" must face out.
5. Secure the mounting plate (B) by inserting the wood screws (D) through the holes on the mounting plate into the plastic anchors (A).

### CONNECTING THE WIRES (Fig. 2)

6. Connect the electrical wires as shown in Fig. 2, making sure that all wire connectors are secured. If your outlet box has a ground wire (green or bare copper), connect the fixture's ground wire to it. Otherwise, connect the fixture's ground wire directly to the mounting plate (B) using the green screw provided. After the wires are connected, tuck them carefully inside the junction box.

### FINISHING THE INSTALLATION (Fig.1)

7. Align the fixture body (E) onto the mounting plate (B) followed by plastic washer (F) and secure with screws (G).
8. Referring to Fig.4 with the product for the shades (I) installation. Place the shade (I) over socket (H) and secure with socket ring (J).
9. Install (1) one medium base bulb (K) up to 100 watts each or CFL or LED equivalent (not included) in accordance with the fixture specification—**DO NOT EXCEED THE MAXIMUM WATTAGE RATING! (NE PAS DEPASSER LA PUISSANCE NOMINALE MAXIMALE!)**
10. (For shade#7984-14/18-143C) Install the glass shade (L) into shade (I).  
(For shade#7982-9-79) Install the two finials to the two holes of shade.
11. To prevent moisture from entering the outlet box and causing a short, use clear caulking (i.e. Indoor/Outdoor silicone sealant) to outline the outside of fixture back plate where it meets the wall leaving a space at the bottom to allow moisture a means to escape (Fig.5)

Your installation is now complete. Return power and test the fixture.

Fig. 1

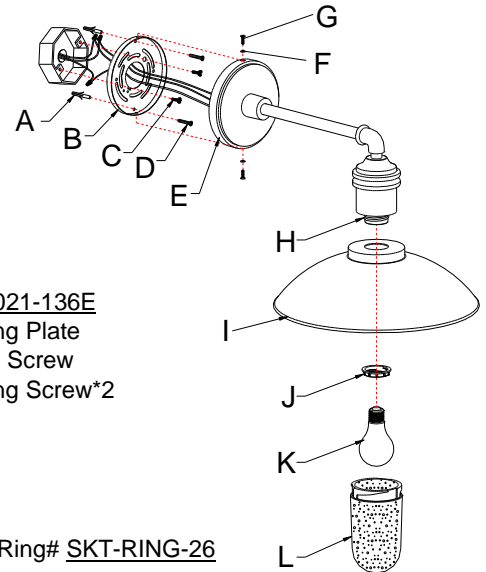

Fig. 2

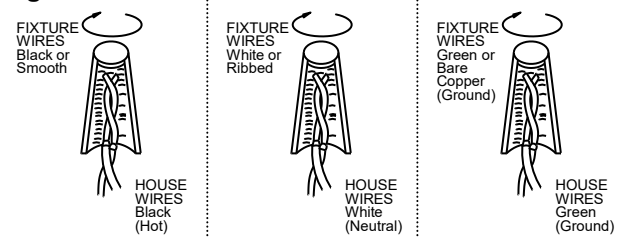

Fig. 5

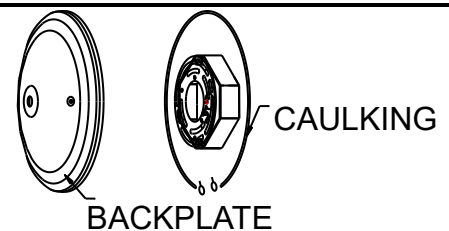
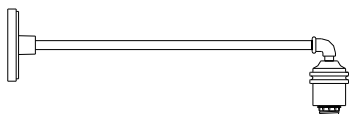

Fig. 3

7971-12A/17A/24A/29A-66



7972-15C/22C/29C-66



7973-18B/24B/30B-66

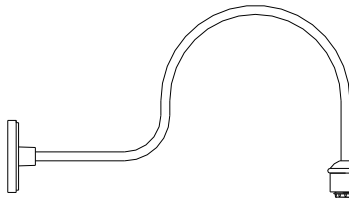
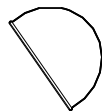
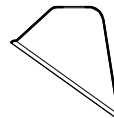

Fig. 4

7980-8-517/66



7981-9-78/66



7982-9-79/66

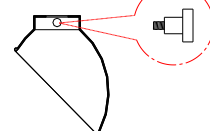

7983-9-545/66

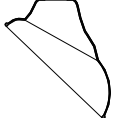

7984-14-143C/66  
 7984-18-143C/66

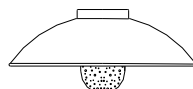

7985-14-79/66  
 7985-18-30/66

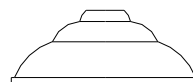

7986-14-172/30/66  
 7985-18-172/30/66

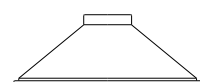

Note: The arms (see Fig. 3) and shades (see Fig.4) can be mixed and matched according to personal preference. Illustration (Fig.1) on this manual is for installation purposes only.

LA-3130E



american  
 lighting  
 association