

# tala<sup>®</sup>

## User Guide

# THE MUSE

---

Thoughtful lighting, responsibly designed in London.

Thank you for making the switch to Tala.  
Discover the full Tala family at [tala.co.uk](http://tala.co.uk)

---

### PREPARATION

Please read instructions thoroughly before installation and keep them for future reference.

Improper assembly can undermine the safety and longevity of the product.

### IMPORTANT

All packaging must be removed and bulb carefully screwed in before turning on.

The product is designed to work with the Tala 12V LED bulb provided. Do not use alternative bulb as product will not work effectively. For replacements, visit the Tala website or contact us for assistance.

Avoid turning on product in hot temperatures above 35°C. Doing so will reduce lumen output and bulb lifespan.

To reduce risk of scratches or marking, ensure bulb is fully housed in the glass case unless changing the bulb.

### WARNING

The Muse is not suitable for recessed or enclosed fixtures or environments, and should be displayed as instructed.

Do not leave the product under direct sunlight while switched on.

Ensure all fixings are tightly sealed and do not allow internal components and surfaces to be exposed to water.

---

SKU – FB-MUSE-PBL-PG-01

SKU – FB-MUSE-PBL-PR-01

SKU – FB-MUSE-PBL-CW-01

SKU – FB-MUSE-PBL-HB-01

SKU – MUSE-PBL-SB-01

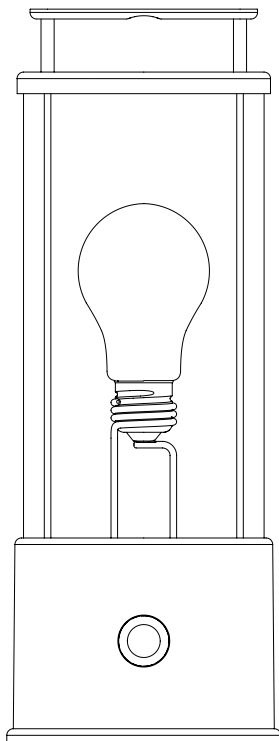

Scan me for more  
technical help



IP44

E27 12V

USB TYPE-C 5V

# The Muse - Provided Components

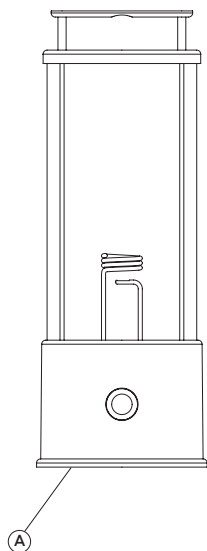

- (A) x1 The Muse luminaire
- (B) x1 The Muse LED bulb in box
- (C) x1 Flat-head screwdriver
- (D) x1 USB Type-C Charging cable

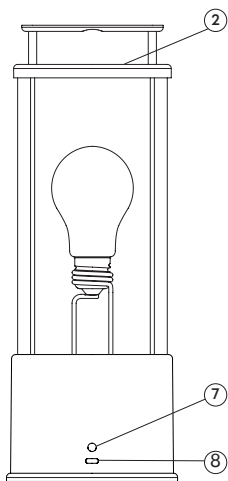
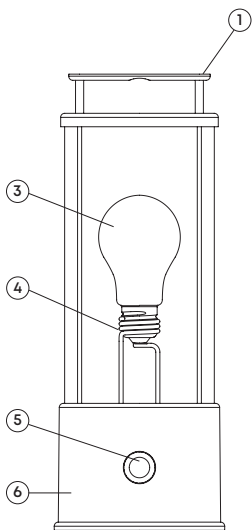
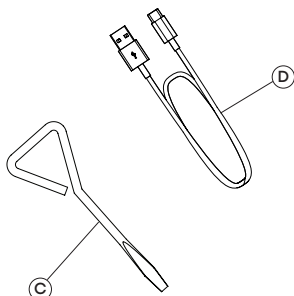
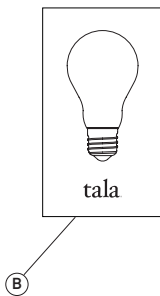

- (1) Handle
- (2) Lid
- (3) 12V LED bulb
- (4) Lampholder coil
- (5) Dimmer dial
- (6) Base
- (7) Battery charge level button
- (8) USB Type-C power input
- (9) Battery charge level Indicator lights

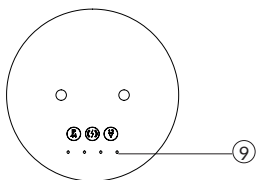

## INITIAL SET UP

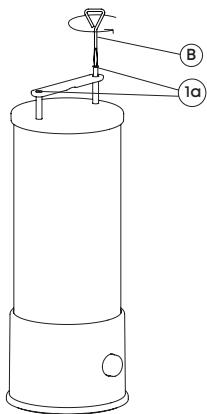

### STEP 1

Release the two screws (1a) on the lid with the provided screwdriver (B) and remove the handle (1).

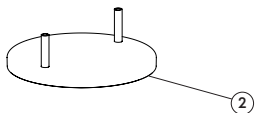
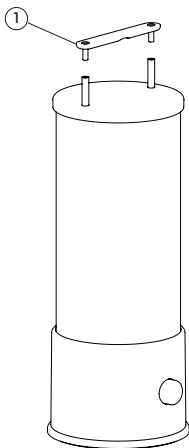

### STEP 2

Lift off the lid (2) and carefully remove all packing material from inside including the bulb box.

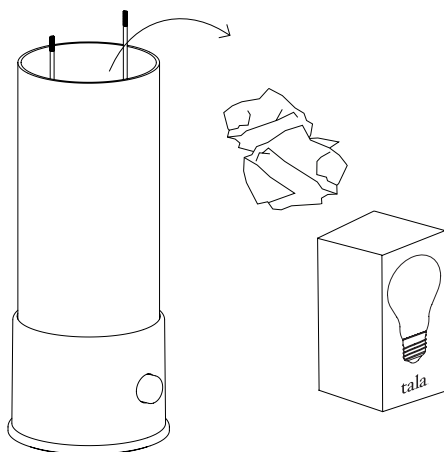

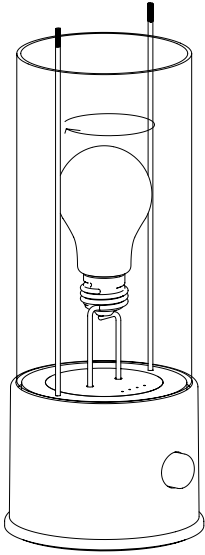

### STEP 3

Remove bulb from box and carefully screw into the lampholder coil by turning the bulb clockwise.

Be careful to align the bulb properly and do not over-tighten.

The glass can be removed again after initial installation for better access to bulb and lampholder coil.

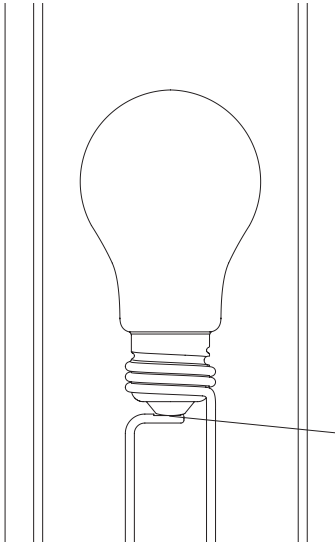

### STEP 4

Ensure the bulb is screwed in fully and contact is made between the base of the bulb and the housing, without overtightening. The bulb and housing are both safe to touch.

### IMPORTANT

Over-tightening or under-tightening of the bulb will cause misalignment. If this occurs, make small adjustments until straight and just touching the contact point.

Contact point

## STEP 5

Return the lid and handle to the original position and tighten screws to secure handle in place.

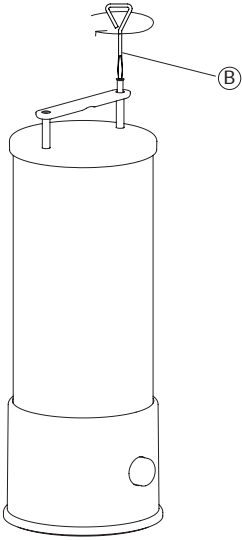

## STEP 6

To turn on, rotate the dial on the front of the lamp clockwise until the bulb lights up.

Adjust the dimmer for your desired light output.

Dial the dimmer up for a cool white light, and dial down for a warm, ambient colour temperature.

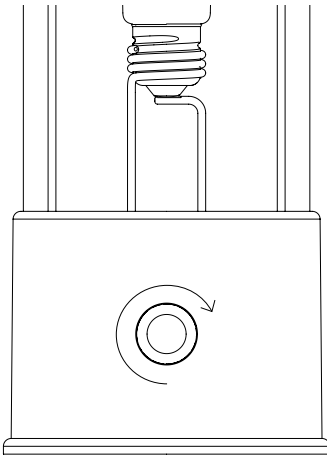

## CHARGING THE MUSE

### OPTION 1: WIRED CHARGING

Insert the provided USB Type-C charging cable into the input at the back of the luminaire base and plug into a USB Type-A adapter.

For optimum charging, use the 0.5m charging cable provided and a 2-Amp USB Type-A adapter.

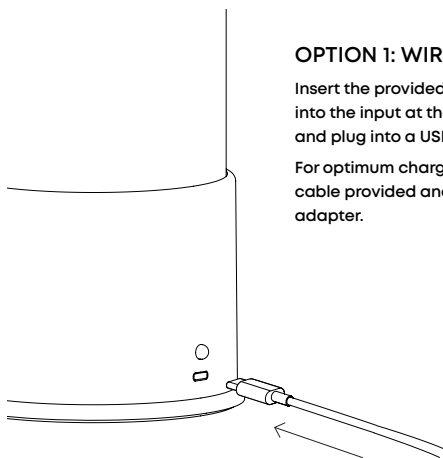

### OPTION 2: WIRELESS CHARGING

Place assembled product flat on a compatible wireless charging pad and ensure it is placed on the centre of the pad for effective charging.

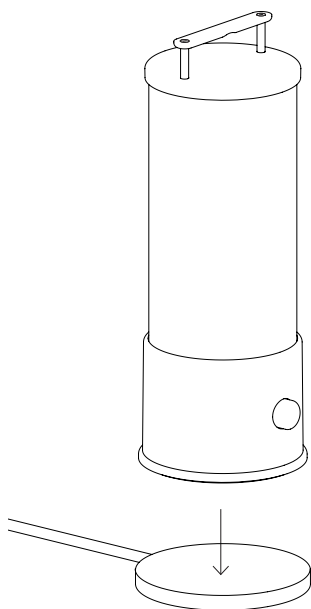

When charging correctly, the battery charge level indicator lights ⑧ will start blinking.  
Total charging time is 8 hours wired or 10 hours wireless.

## BATTERY LEVEL INDICATOR

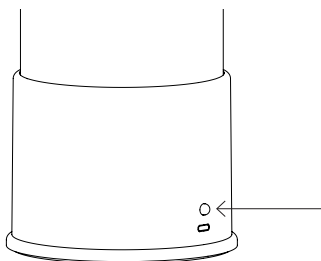

Press the button on the back of the lamp to display the battery level indicators on the front of the lamp.

Press the button twice to turn the indicator lights off.

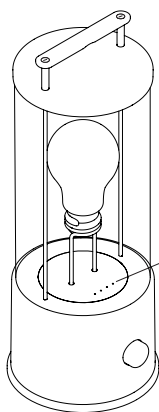

**Blinking: <10% Battery remaining**

**Solid: 25% Battery remaining**

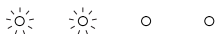

**50% Battery remaining**

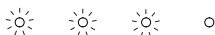

**75% Battery remaining**



**>75% Battery remaining**

## IMPORTANT

The Muse uses a Lithium-ion battery pack rated for 1000 full charge/discharge cycles. After this, the battery capacity may begin to noticeably degrade.

Tips to prolong the battery life are:

- Once fully charged, please remove from charger
- Avoid allowing the battery to reach 0%. Recharge when the low-battery indicator begins to blink
- When not in use, store The Muse with 25-50% battery (indicators 1-2)
- During charge, make sure The Muse is uncovered to avoid over-heating
- Depending on the charger power output, The Muse may not always charge to 100% if the bulb is on at the same time

The battery, bulb, and glass can all be easily replaced. For replacement parts, please visit our website or contact us at [customerservice@tala.co.uk](mailto:customerservice@tala.co.uk)

## CARE AND CLEANING

We recommend cleaning with a soft dry cloth. If required, further cleaning can be achieved with warm, soapy water. Do not use abrasive materials as these will damage the finish of the product. Do not use alcohol or other solvents.

Extended use in wet or humid locations can cause condensation to form inside the glass tube. Please follow 'Initial Set-Up' steps to open the lid and allow condensation to evaporate. To avoid condensation, it is recommended that the lamp is not exposed to wet weather for long periods, such as left out in the rain overnight

## WARRANTY AND AFTER-CARE

This product has a two-year warranty. If there appears to be a functional defect with the product during this time, please contact our team at [customerservice@tala.co.uk](mailto:customerservice@tala.co.uk).

---

### THE MUSE

Ø12.5x33.8cm / Ø5x13.3in  
IP44 | Suitable for Wet locations  
5V/2A USB Type-C | 5W wireless  
Battery: Li-ion 13.2Ah 3.7V 48.8Wh  
Ta max. 35°C  
Only use with Tala The Muse 12V bulbs

This symbol  indicates that electrical and electronic equipment (WEEE) should not be mixed with general household waste. For recovery and recycling, please take this product to a designated collection point where it will be accepted free of charge. Many retailers offer this instore. Disposing of this product correctly will help save valuable resources and prevent any potential negative effects on human health and the environment.

### BULB

12V | 6W | 400lm | E27  
35W replacement | 0.5A  
CRI 97, R9 95 | 2000-2800K  
Ø6 x 11cm | Flicker <1%

---

## Join the Community

Instagram: @tala | Facebook: talaHQ | Pinterest: TalaLED | Tag: lighttoliveby  
Tala Energy Ltd, 25B Vyner Street, London, UK, E2 9DG | [hello@tala.co.uk](mailto:hello@tala.co.uk)  
Tala Europe B.V, Bertus Aafjeshove 40, Nieuwegein 3437JN, Netherlands  
Tala North America, Inc. 2 Research Place, Suite 300, Rockville, MD 20850, USA

---

NOTE: This equipment has been tested and found to comply with the limits for a Class B digital device, pursuant to part 15 of the FCC Rules. These limits are designed to provide reasonable protection against harmful interference in a residential installation. This equipment generates, uses and can radiate radio frequency energy and, if not installed and used in accordance with the instructions, may cause harmful interference to radio communications. However, there is no guarantee that interference will not occur in a particular installation. If this equipment does cause harmful interference to radio or television reception, which can be determined by turning the equipment off and on, the user is encouraged to try to correct the interference by one or more of the following measures: —Reorient or relocate the receiving antenna. —Increase the separation between the equipment and receiver. —Connect the equipment into an outlet on a circuit different from that to which the receiver is connected. —Consult the dealer or an experienced radio/TV technician for help. Caution; changes or modifications not expressly approved by the party responsible for compliance could void the user's authority to operate the equipment.