

Installation Guide

TRIPLE PENDANT

Thoughtful lighting, responsibly designed in London.

Thank you for making the switch to Tala.
Discover the full Tala family at us.tala.co.uk

BEFORE STARTING

We advise the fitting of our canopy and pendants to be performed by a qualified electrician. Please read through these instructions before commencing work, and keep them for future reference. Please take extreme care when carrying out these instructions.

IMPORTANT

This light fitting must be connected to the supply earth. If your lighting circuit does not have an earth, ask a qualified electrician to provide an earth facility. This light fitting is suitable for indoor use only. This fitting operates on 120V mains voltage. Please visit our website to see our recommended dimmers.

WARNING

Always switch off electricity supply at the mains during installation and maintenance. We recommend that the fuse is withdrawn or the circuit breaker is switched off whilst work is in progress. Do not just turn off at the wall switch. All fittings must be installed in accordance with current NFPA 70, National Electrical Code (NEC).

RECOMMENDED EQUIPMENT

- Small flat head screwdriver
 - Wire strippers
 - Insulation tape
 - M10 (17mm) (5/8IN) wrench or Adjustable wrench
- Further equipment may be required for fixing to your ceiling.

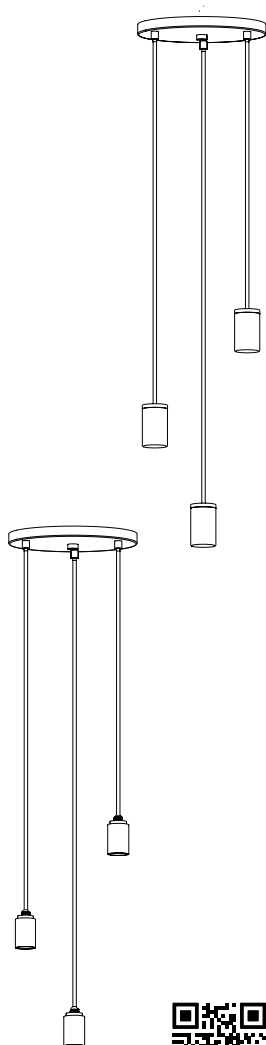

Scan me for more technical help

FOR INDOOR USE ONLY

SKU - CP-WHT-SML-WP-01-US
 SKU - CP-WHT-SML-OP-01-US
 SKU - CP-WHT-SML-GP-01-US
 SKU - CP-WHT-SML-BP-01-US

SKU - CP-BLK-SML-GP-01-US
 SKU - CP-BLK-SML-BP-01-US
 SKU - CP-BLK-SML-OP-01-US
 SKU - CP-BLK-SML-WP-01-US



Triple Pendant - Provided Components

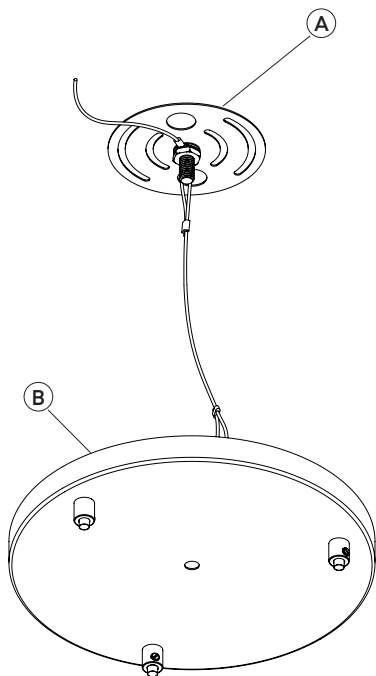

- (A) x1 Ceiling bracket
- (B) x1 Ceiling plate
- (C) x3 M10,
Internal tooth washer
- (D) x1 Nut
- (E) x3 Tala Pendants
Oak, Walnut, Brass or Graphite

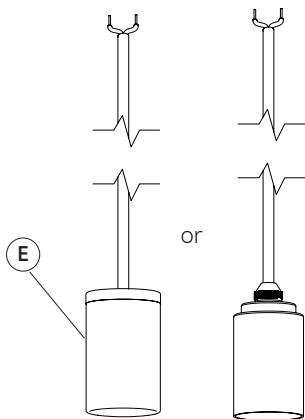
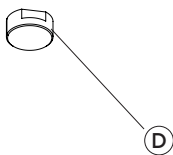
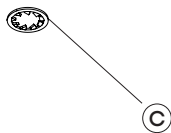

STEP 1

Attach (A) to the ceiling using screws and plug. Always choose screws and plugs that are appropriate for the ceiling.

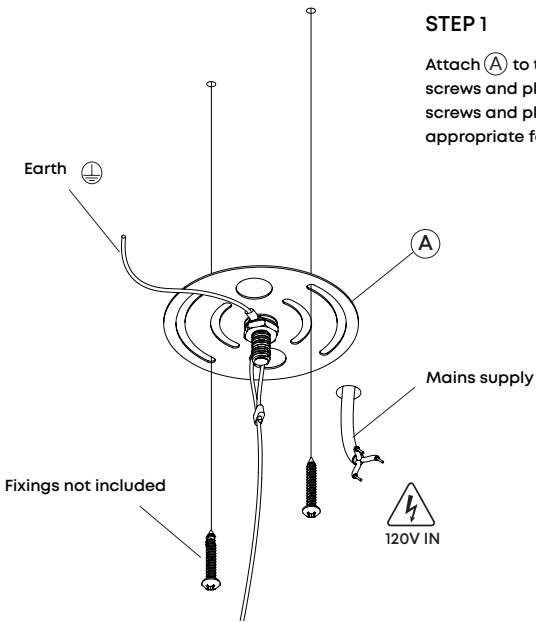

STEP 2

Thread all three pendant cables (E) through ceiling plate cord grips (B).

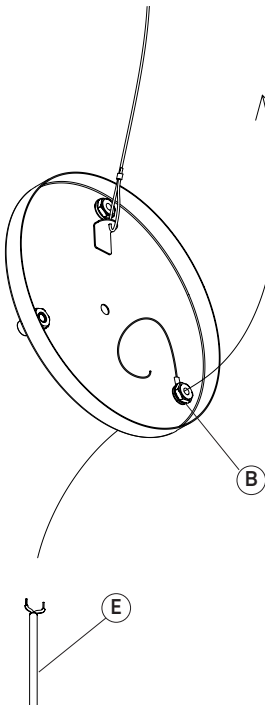

STEP 3

Pull pendant cables (E) through cord grips (B) to your desired length. Using a flat head screwdriver, tighten set screws (B1) to secure them.

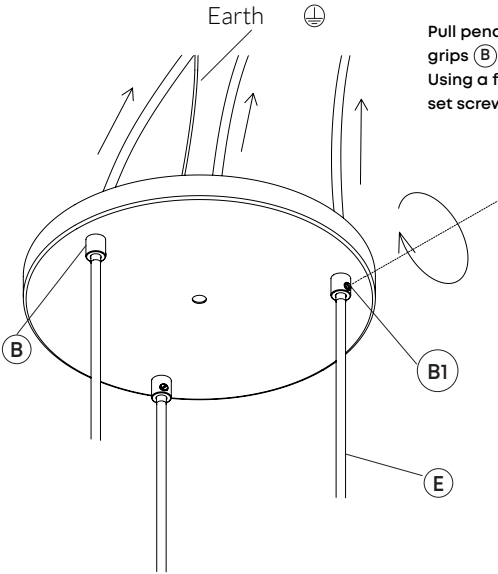

STEP 4

Cut off excess cable and strip wires to expose the copper core. Maintain all double insulation.

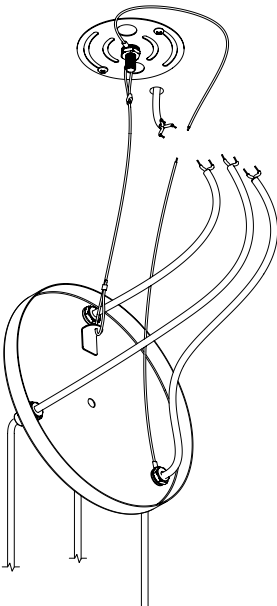

STEP 5

Connect the pendants, plate and mains wiring as shown.

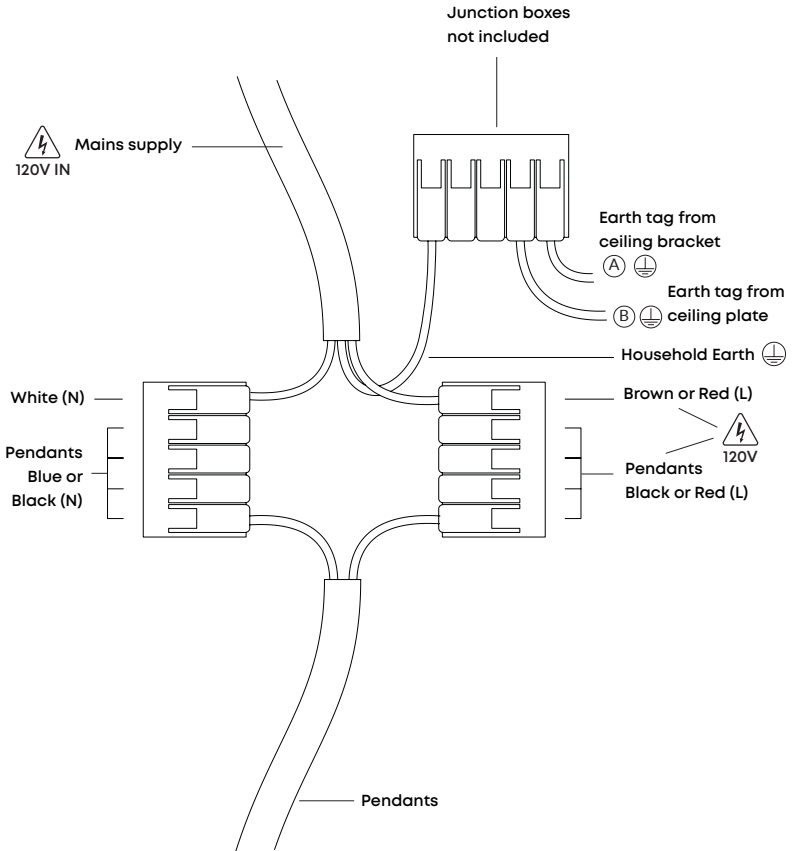

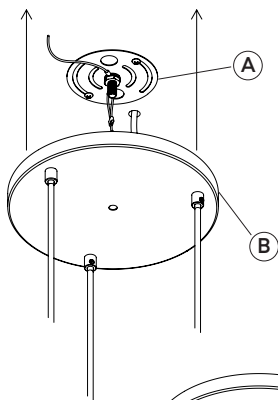

STEP 6

Move (B) up onto (A). Use toothed washer (C) and nut (D) to secure it in place.

Secure by carefully tightening with the correct sized spanner.

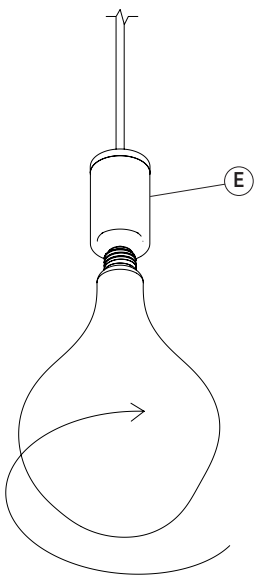
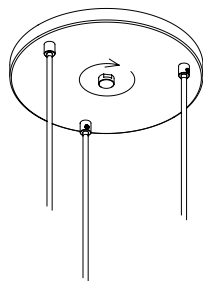
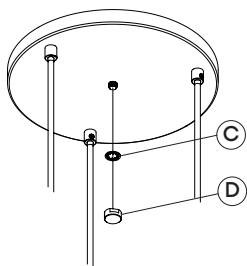

STEP 7

Screw bulbs into pendants (E) clockwise.

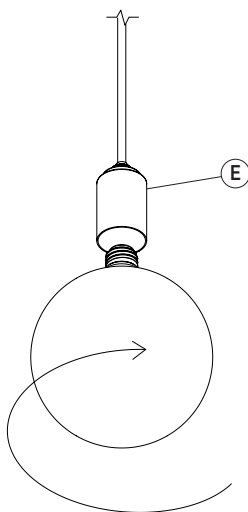

PENDANT DISPLAY GUIDE

ADJUSTING THE CORD

To adjust the cord to your desired length, using a flat head screw driver, loosen the grub/set screw ① and push the cable up into the ceiling plate.

Secure the cable in place by re-tightening the grub screw.

Maintain all double insulation.

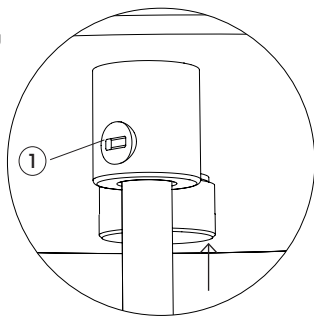

MINIMUM CORD LENGTH ①

For all bulbs shortest recommended cord length is 14 in

DISTANCE BETWEEN PENDANTS ②

Recommended minimum distance between pendant, dependant on bulb style, are as follows:

- Voronoi I - 6 in
- Voronoi II - 8 in
- Voronoi III - 1⁴ in
- Sphere IV - 6 in
- All other bulbs - 4 in

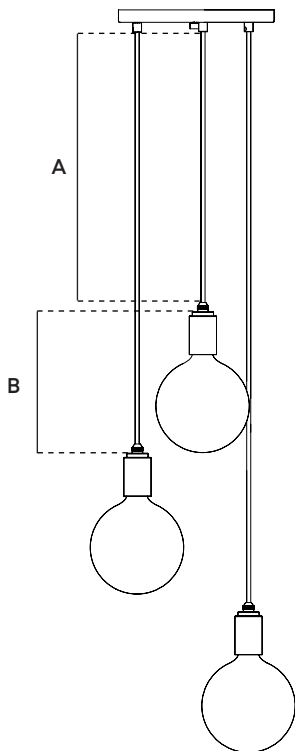

PENDANTS - RECOMMENDED CABLE LENGTHS

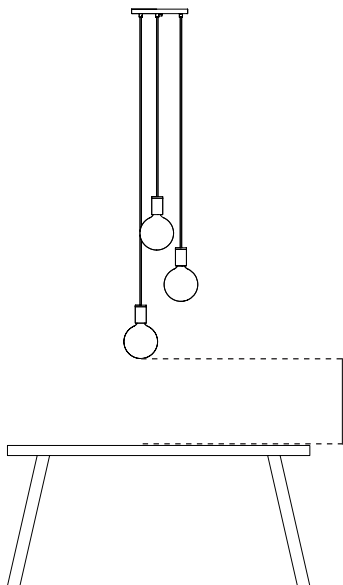

SCENARIO 1

Above a coffee or dining table,
or where height is required for
seated tasks

Minimum Distance
28 in

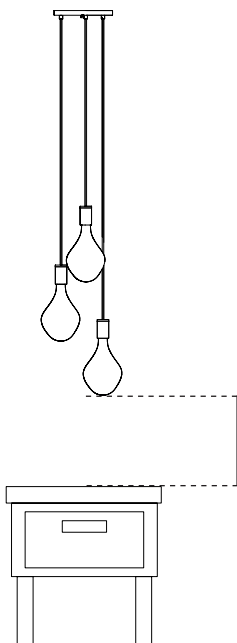

SCENARIO 2

Above side tables, or where
height is required for storage

Minimum Distance
19 in

SCENARIO 3

Above a kitchen island or bar,
or where height is required for
standing tasks

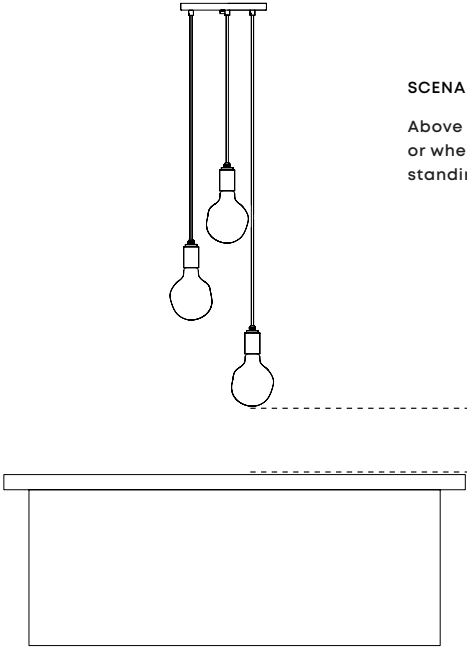

Minimum Distance
32 in

SCENARIO 4

Above a stairwell or walkway,
or where height is required for
walking underneath.

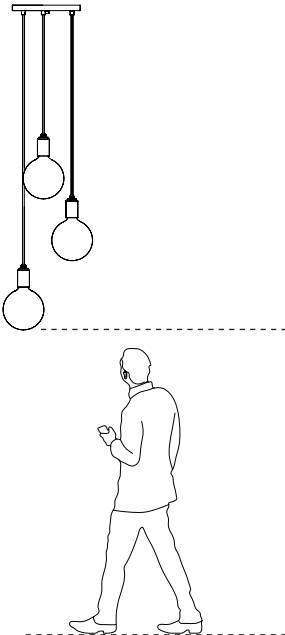

Minimum Distance
7 Ft

WARRANTY AND AFTER-CARE

This product has a two-year warranty. If there appears to be a functional defect with the product during this time, please contact our team at customerservice@tala.co.uk.

Please note, the flexible cable attached to this luminaire cannot be replaced; if the cable is damaged, recycle the luminaire and seek a replacement.

Join the Community

Instagram: @tala | Facebook: talaHQ | Pinterest: TalaLED | Tag: lighttoliveby
Tala Energy Ltd. 25B Vyner Street, London, E2 9DG | hello@tala.co.uk
Tala North America, Inc. 2 Research Place, Suite 300, Rockville, MD 20850