



MEGAFONO
 PENDANT
 FAMILY

| |
|---------|
| 16x |
| ■ E9566 |
| ■ E9567 |

| |
|---------|
| 12x |
| ■ E9568 |
| ■ E9569 |

| |
|---------|
| 6x |
| ■ E9576 |
| ■ E9577 |

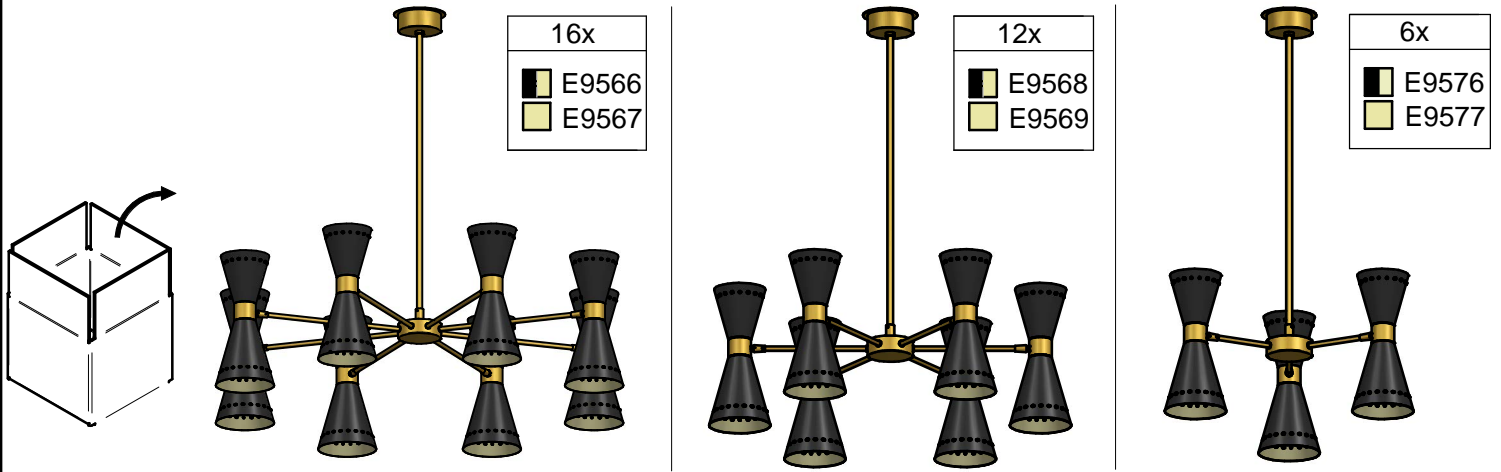

WARNING:
 INSTALL PRODUCT IN ACCORDANCE WITH LOCAL AND NATIONAL ELECTRICAL CODES BY A QUALIFIED ELECTRICIAN

WARNING:
 FAILURE TO COMPLY WITH THE INSTALLATION INSTRUCTIONS MAY RESULT IN DEATH OR SEVERE INJURY.

WARNING:
 READ ALL SAFETY INSTRUCTIONS INCLUDED WITH LUMINAIRE BEFORE INSTALLING LUMINAIRE. SAVE INSTRUCTIONS FOR FUTURE USE.

CAUTION:
 THIS IS AN ELECTRONIC DEVICE. CARE MUST BE TAKEN DURING STORAGE AND HANDLING. STORE IN A CLEAN, COOL AND DRY LOCATION. ELECTROSTATIC DISCHARGE (ESD) CAN HARM THIS PRODUCT. AVOID STATIC DISCHARGE WHILE HANDLING THIS PRODUCT.

CAUTION:
 INTER-LUX IS NOT RESPONSIBLE FOR THE STRUCTURAL INTEGRITY OF THE BUILDING TO SUPPORT THE LUMINAIRE. ADDITIONAL BACKING MAY BE REQUIRED.

LOCATE AND REVIEW ANY CONSTRUCTION PLANS AND INTER-LUX RECORD DRAWINGS FOR ALL FIXTURE RUNS. IT IS RECOMMENDED TO LOCARE AND LAY OUT ALL COMPONENTS FOR EACH FIXTURE "RUN". A FIXTURE RUN TYPICALLY CONSISTS OF JOINERS, LENGHTS OF HOUSING, AND ENDCAPS. BE SURE TO IDENTIFY ALL CORRECT LENGHTS FOR EACH FIXTURE RUN.

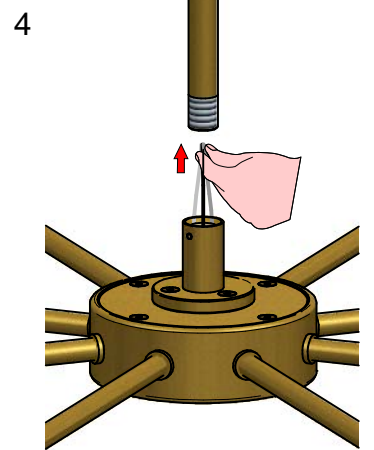
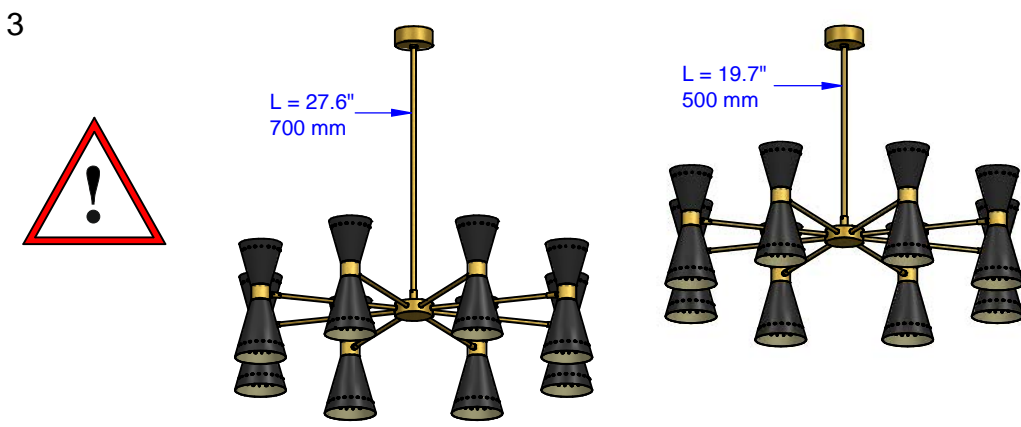
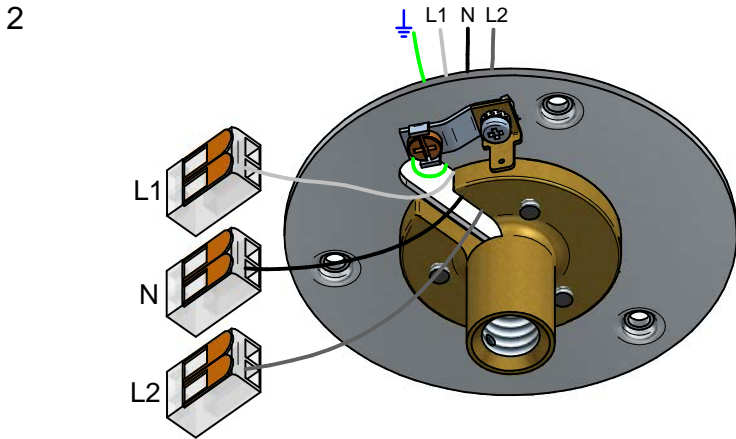
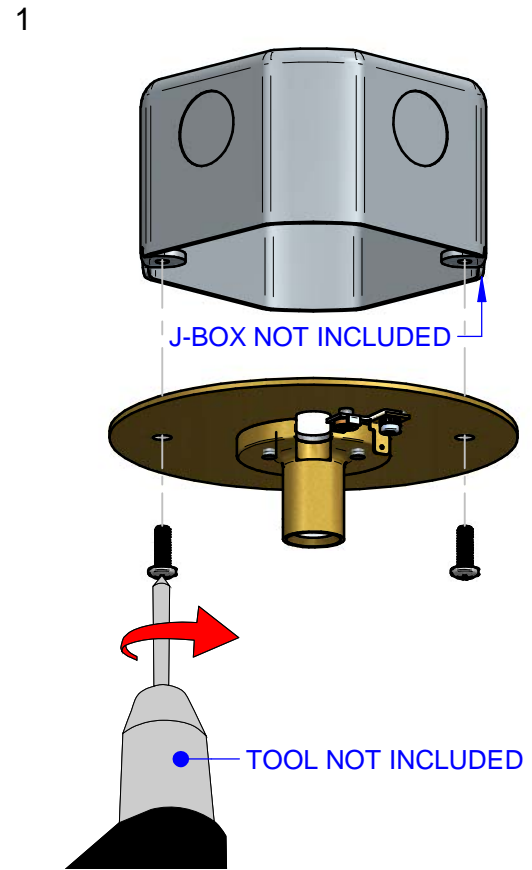

16x

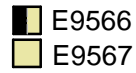

12x

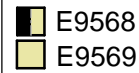

6x

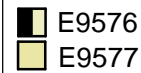

5

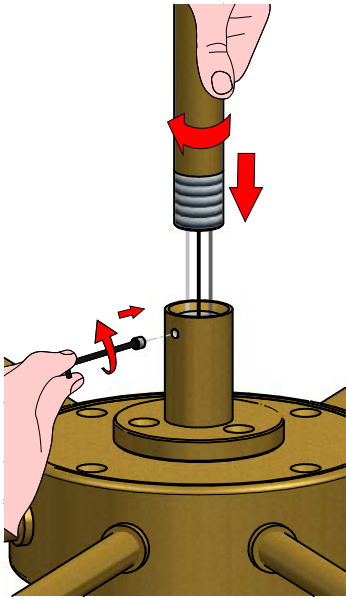

6

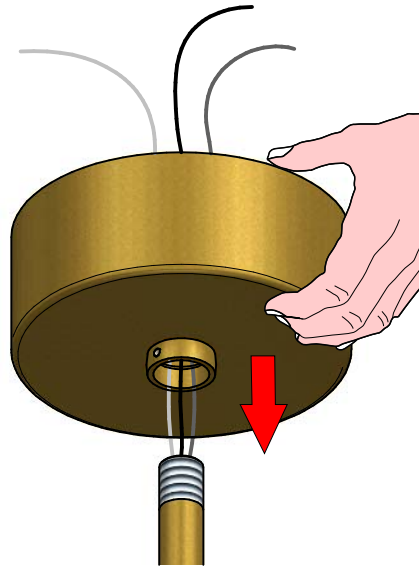

7

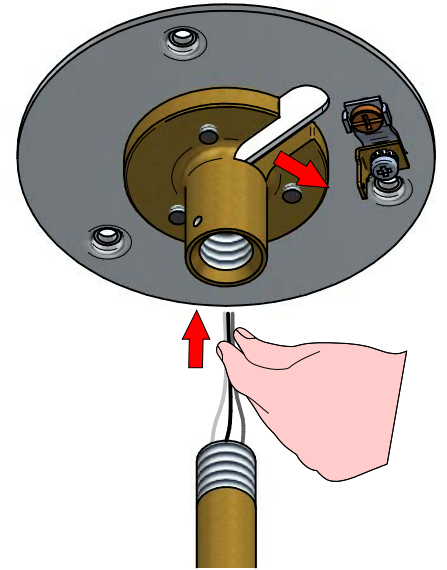

8

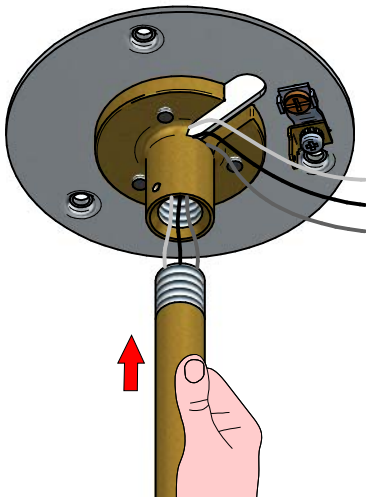

9

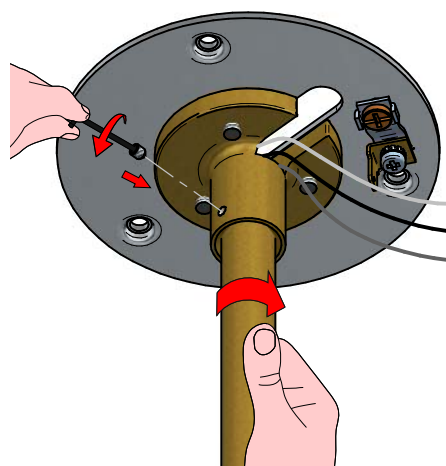

10

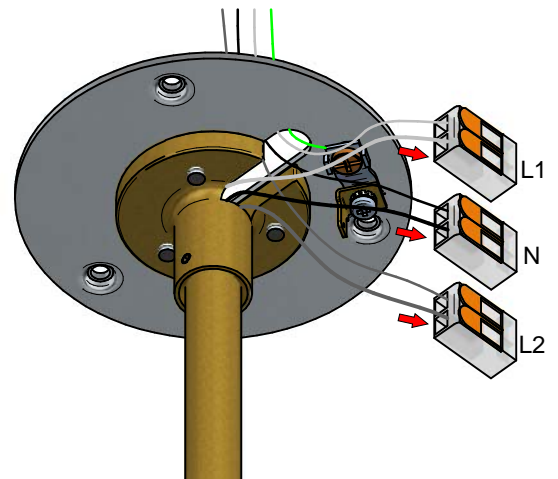

11

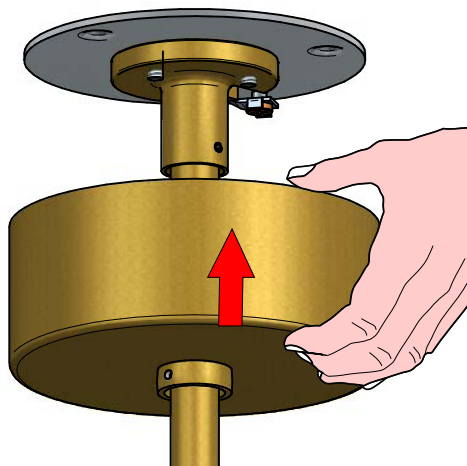

12

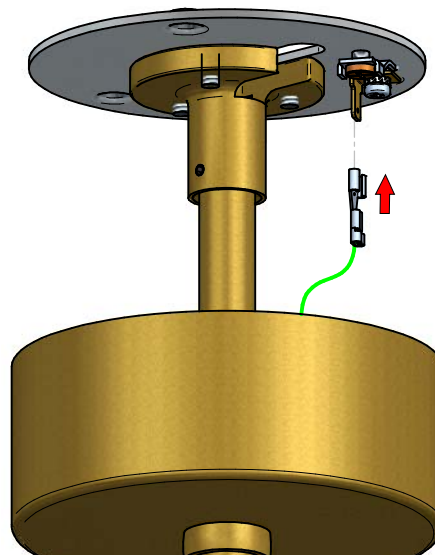

13

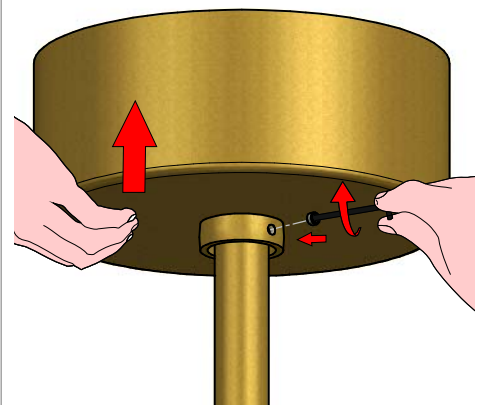



MEGAFONO
 PENDANT
 FAMILY

| |
|-------|
| 16x |
| E9566 |
| E9567 |

| |
|-------|
| 12x |
| E9568 |
| E9569 |

| |
|-------|
| 6x |
| E9576 |
| E9577 |

OFF OFF

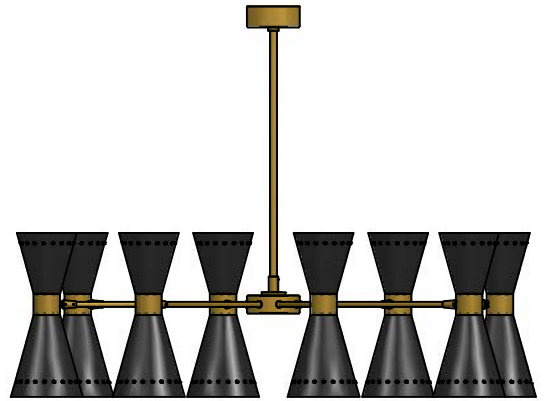
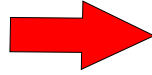
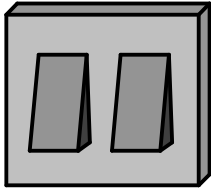

ON OFF

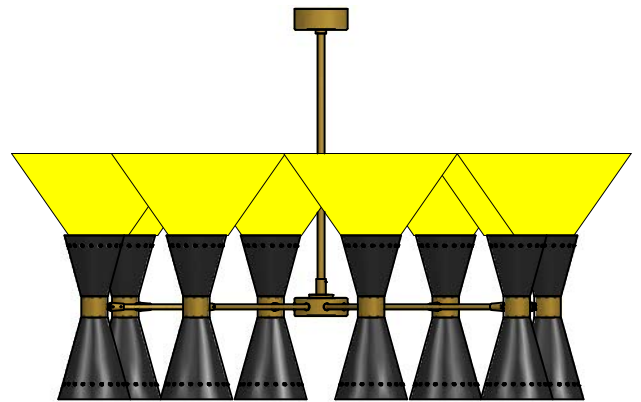
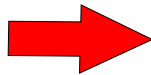
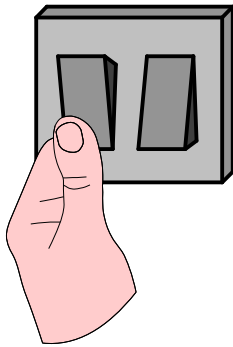

OFF ON

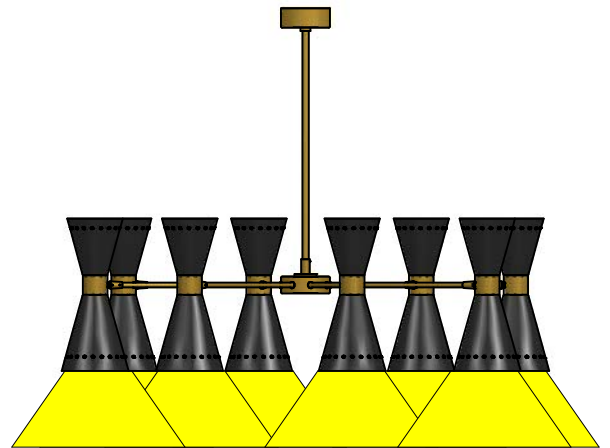
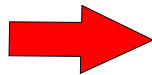
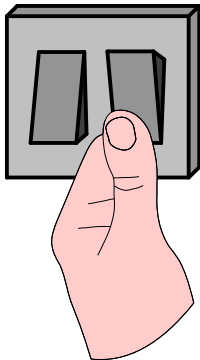

ON ON

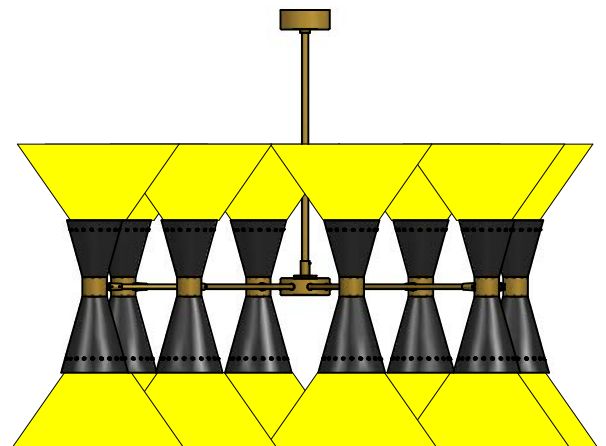
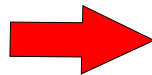
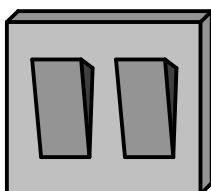



MEGAFONO
PENDANT
FAMILY

| |
|-------|
| 16x |
| E9566 |
| E9567 |

| |
|-------|
| 12x |
| E9568 |
| E9569 |

| |
|-------|
| 6x |
| E9576 |
| E9577 |



OFF OFF

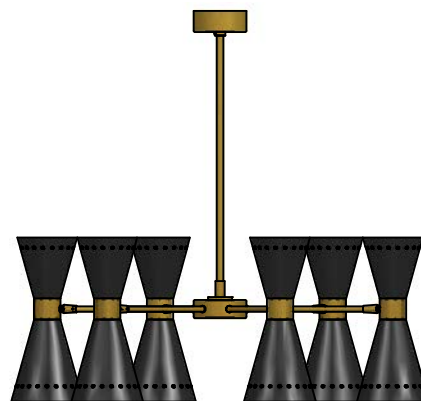
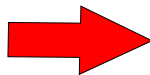
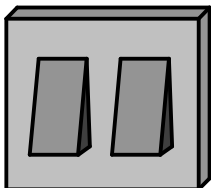

ON OFF

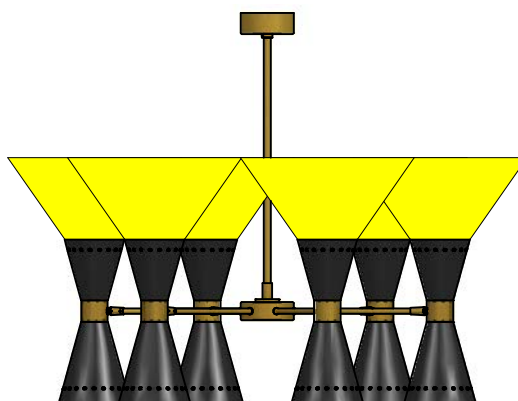
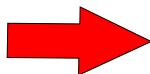
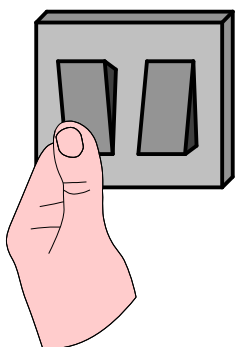

OFF ON

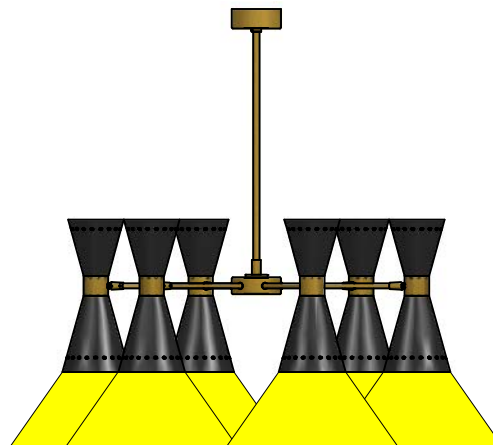
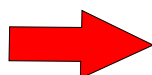
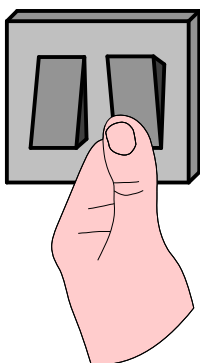

ON ON

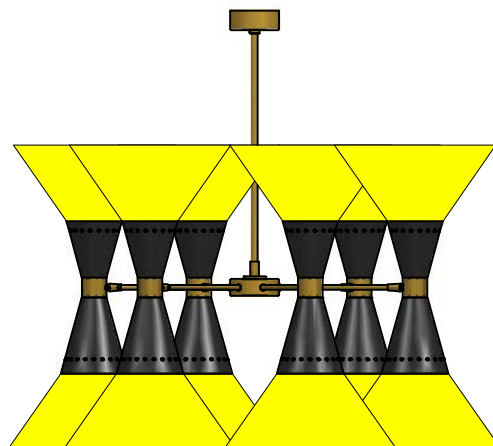
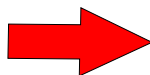
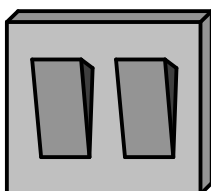

MEGAFONO
PENDANT
FAMILY

16x

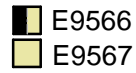

12x

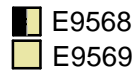

6x

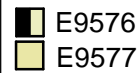
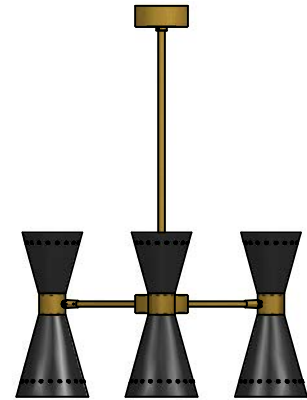
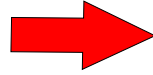
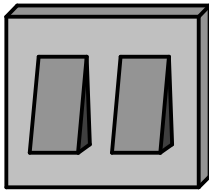
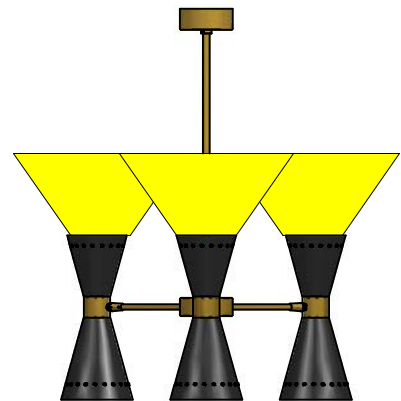
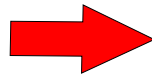
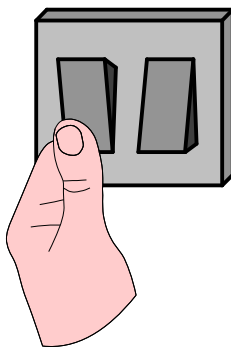
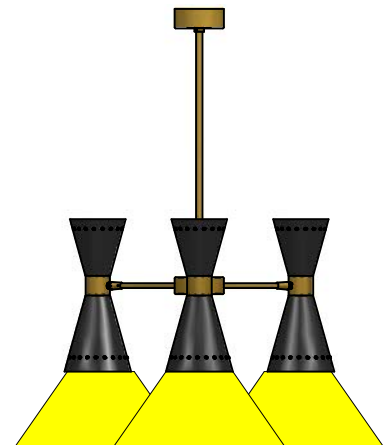
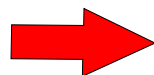
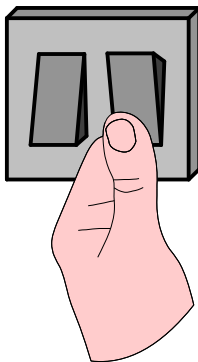
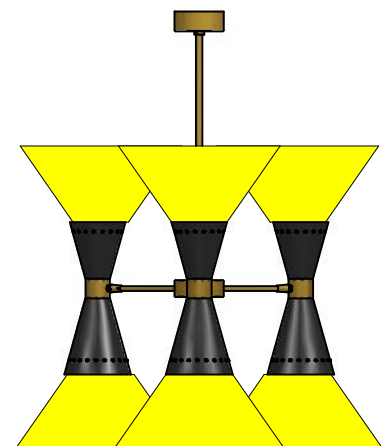
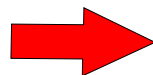
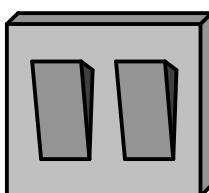
**OFF OFF****ON OFF****OFF ON****ON ON**

MEGAFONO
PENDANT
FAMILY

16x

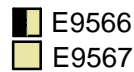

12x

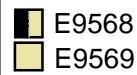

6x

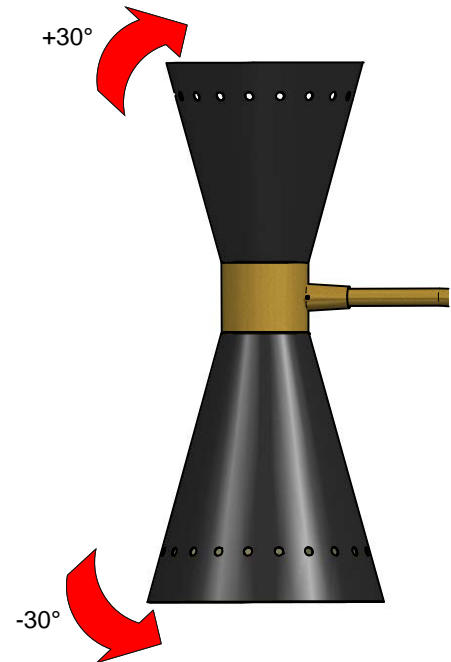
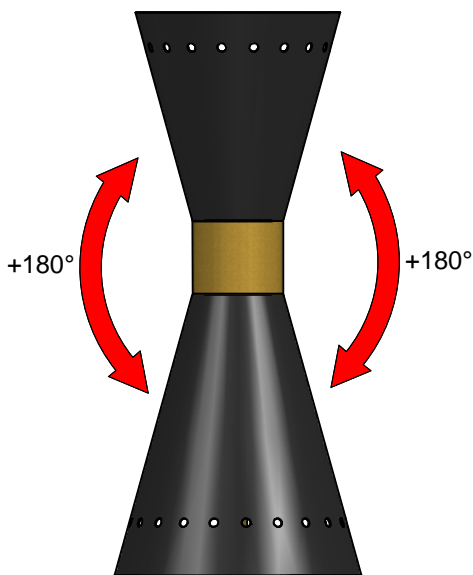
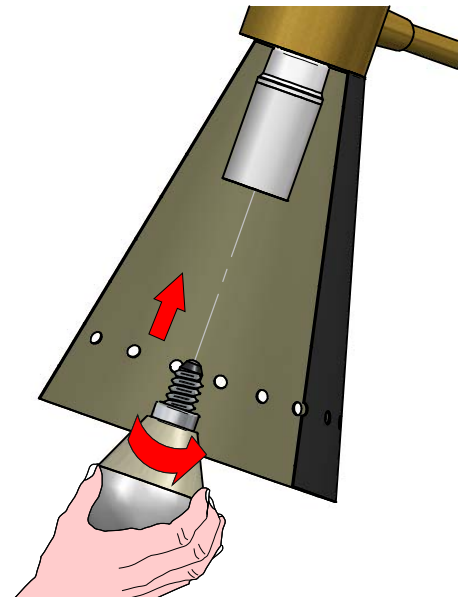
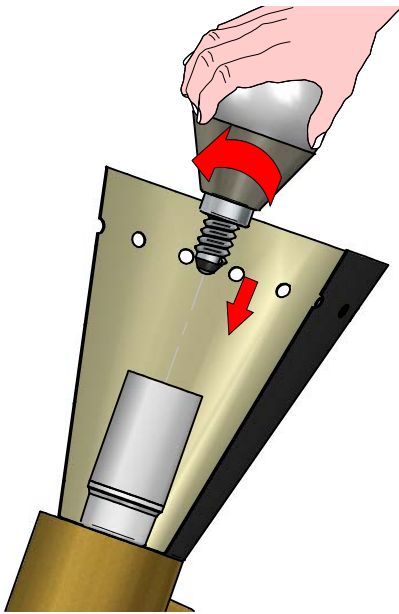
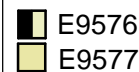

THIS PRODUCT MUST BE INSTALLED IN ACCORDANCE WITH THE APPLICABLE INSTALLATION CODE BY A PERSON FAMILIAR WITH THE CONSTRUCTION AND OPERATION OF THE PRODUCT AND THE HAZARDS INVOLVED

MOUNTING INSTRUCTIONS

READ ALL OF THESE INSTRUCTIONS BEFORE INSTALLING FIXTURES

- Keep all of the instructions for future reference
- Turn off power before installing fixture
- Installation is to be performed by a qualified electrician only
- All installations must conform to the National Electrical Code as well as all local jurisdictional codes and regulations
- Any modification of the luminaire will void any and all written or implied warranties
- The manufacture accepts no responsibility for damage to persons or property arising through improper use or installation

