



LAMPIATTA
 TABLE/WALL
 FAMILY



E8971



E8972



E8973

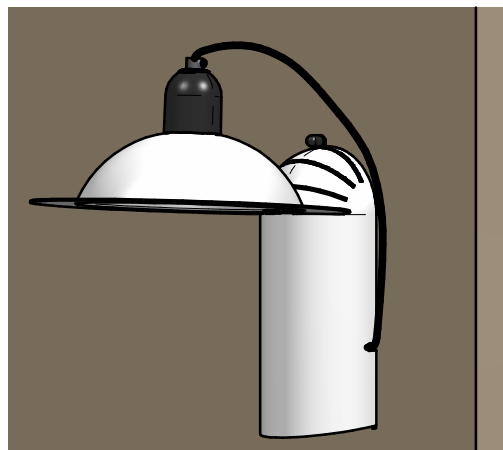
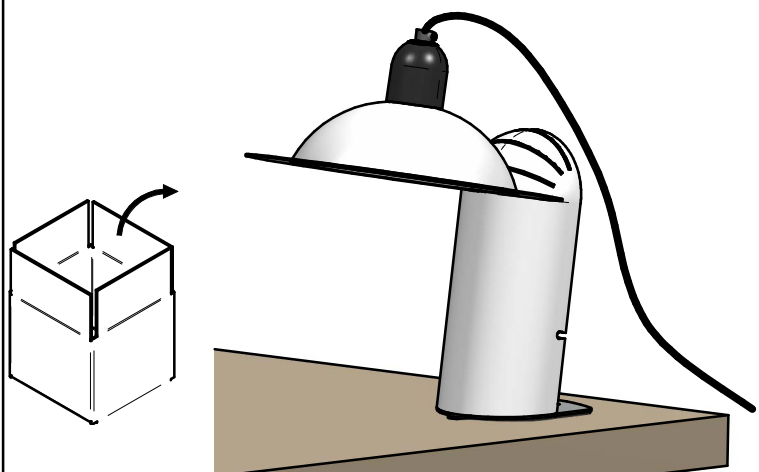

WARNING:

INSTALL PRODUCT IN ACCORDANCE WITH LOCAL AND NATIONAL ELECTRICAL CODES BY A QUALIFIED ELECTRICIAN



WARNING:

FAILURE TO COMPLY WITH THE INSTALLATION INSTRUCTIONS MAY RESULT IN DEATH OR SEVERE INJURY.



WARNING:

READ ALL SAFETY INSTRUCTIONS INCLUDED WITH LUMINAIRE BEFORE INSTALLING LUMINAIRE. SAVE INSTRUCTIONS FOR FUTURE USE.

CAUTION:

THIS IS AN ELECTRONIC DEVICE. CARE MUST BE TAKEN DURING STORAGE AND HANDLING. STORE IN A CLEAN, COOL AND DRY LOCATION. ELECTROSTATIC DISCHARGE (ESD) CAN HARM THIS PRODUCT. AVOID STATIC DISCHARGE WHILE HANDLING THIS PRODUCT.

CAUTION:

INTER-LUX IS NOT RESPONSIBLE FOR THE STRUCTURAL INTEGRITY OF THE BUILDING TO SUPPORT THE LUMINAIRE. ADDITIONAL BACKING MAY BE REQUIRED.

Classic A Mirror



LED Bulb
 7 W 650 lm
 2700 K CRI \geq 80
NOT INCLUDED

LOCATE AND REVIEW ANY CONSTRUCTION PLANS AND INTER-LUX RECORD DRAWINGS FOR ALL FIXTURE RUNS. IT IS RECOMMENDED TO LOCARE AND LAY OUT ALL COMPONENTS FOR EACH FIXTURE "RUN". A FIXTURE RUN TYPICALLY CONSISTS OF JOINERS, LENGHTS OF HOUSING, AND ENDCAPS. BE SURE TO IDENTIFY ALL CORRECT LENGHTS FOR EACH FIXTURE RUN.

INSTALLATION INSTRUCTIONS

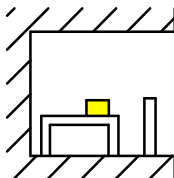

1

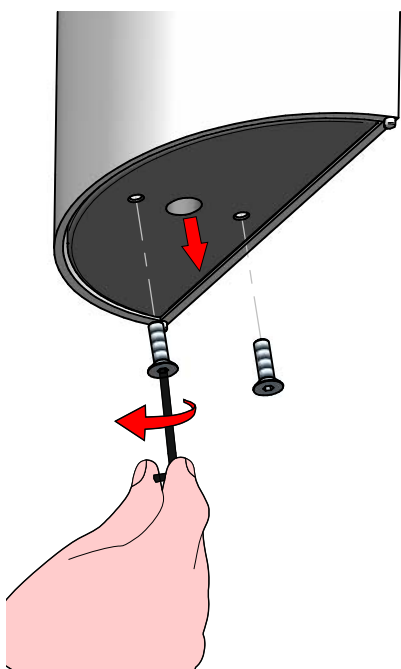

2

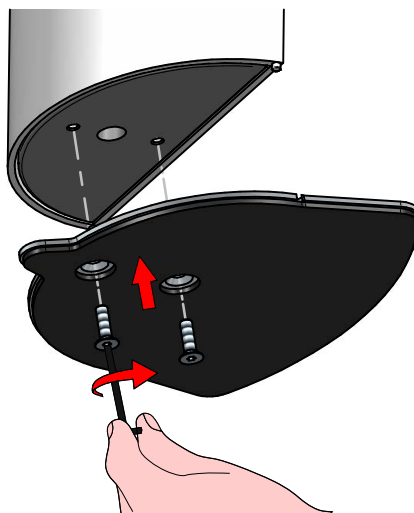

3

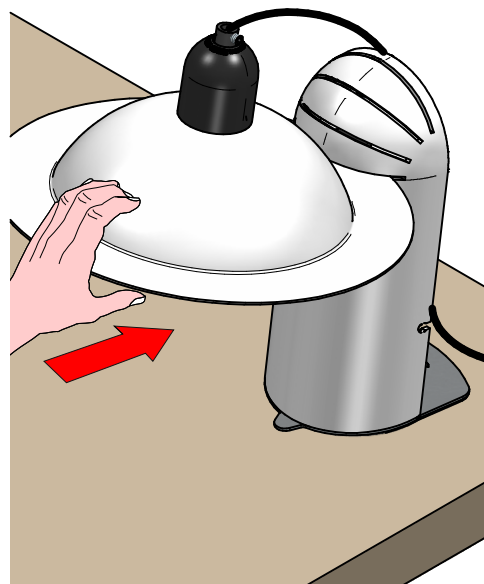



LAMPIATTA
TABLE/WALL
FAMILY



E8971



E8972



E8973



4



5



6

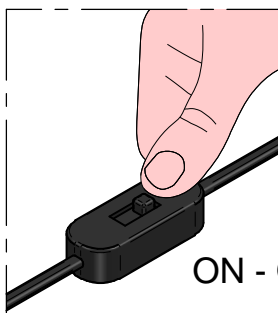
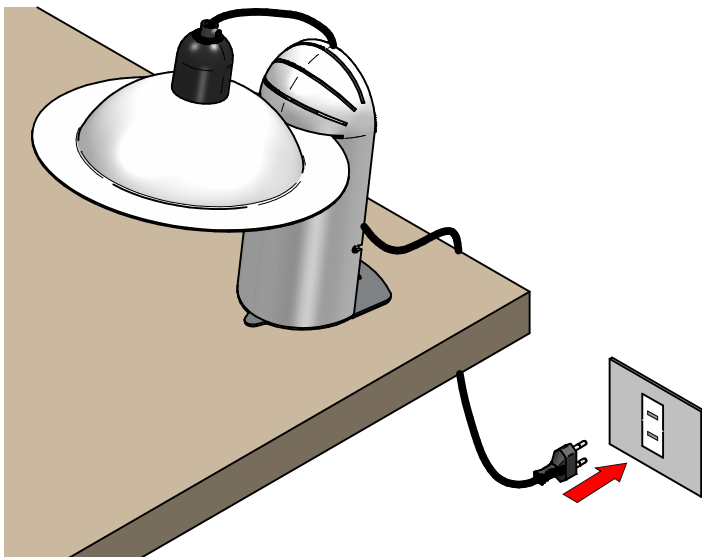

ON - OFF





LAMPIATTA
TABLE/WALL
FAMILY



E8971



E8972



E8973

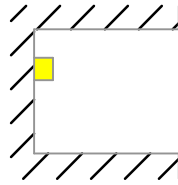

1

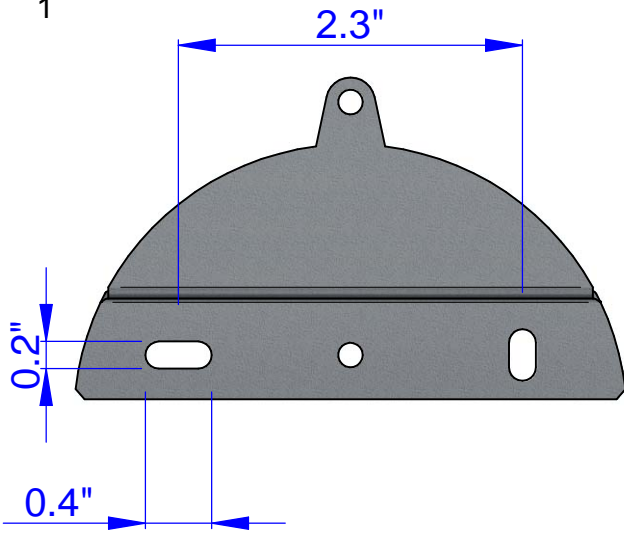

2

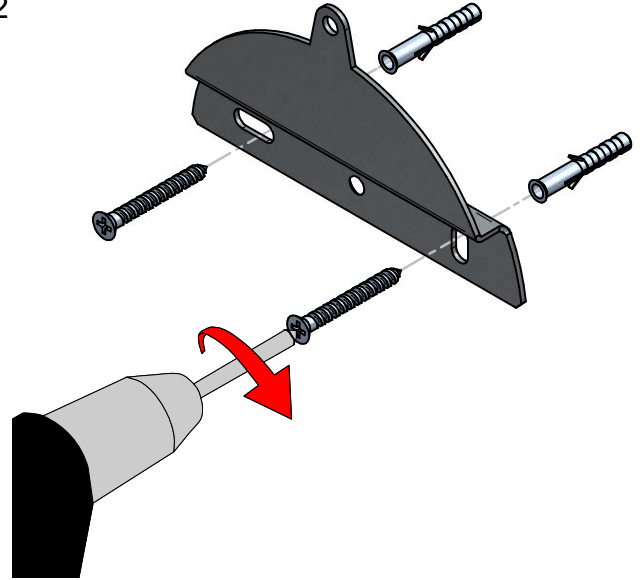

3

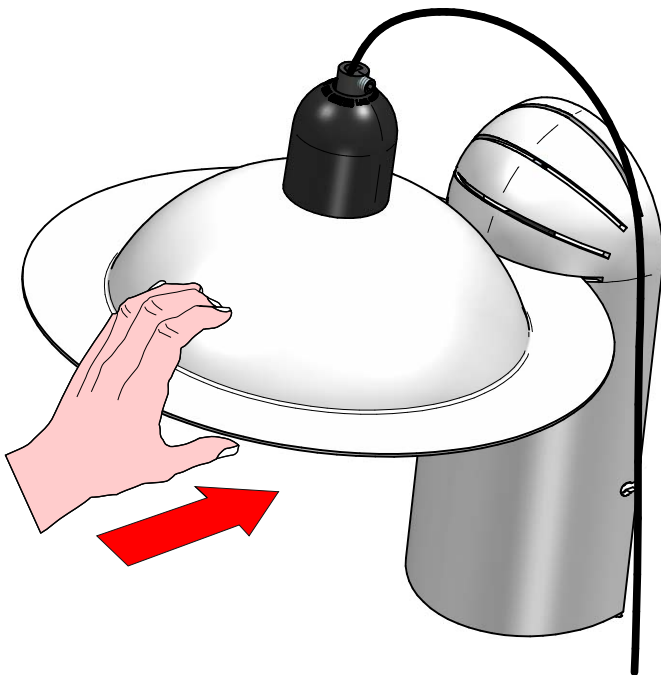

4



5

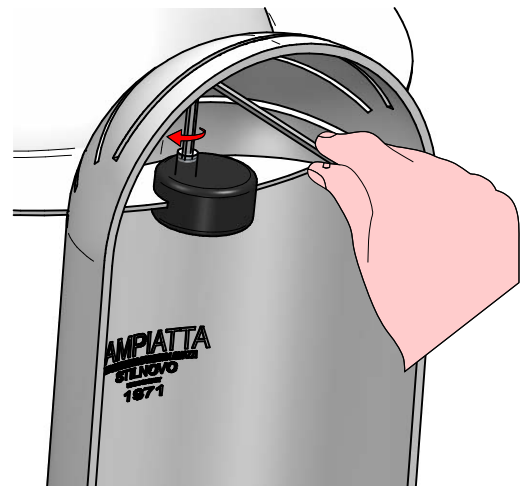



LAMPIATTA
TABLE/WALL
FAMILY



E8971



E8972



E8973

6

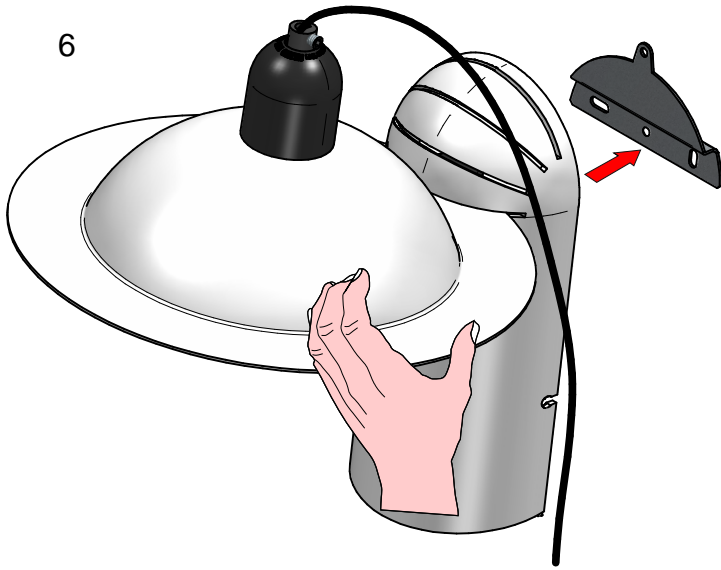

7

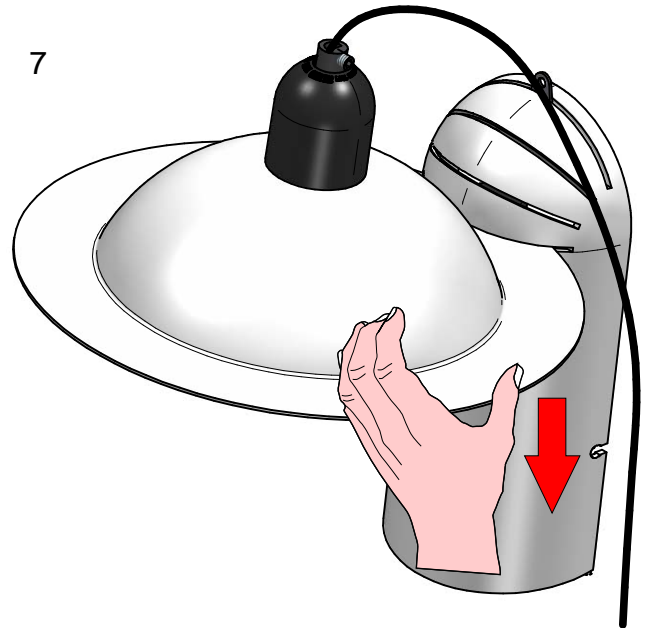

8

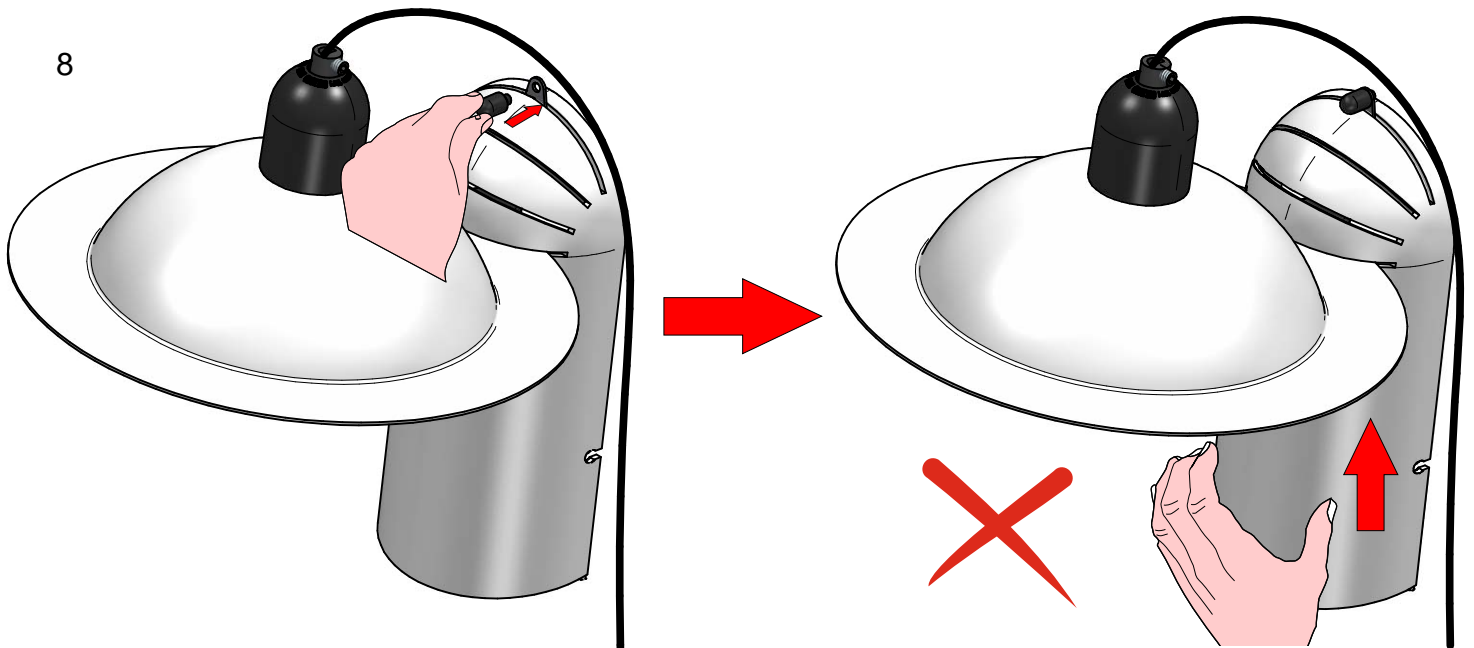

9.a

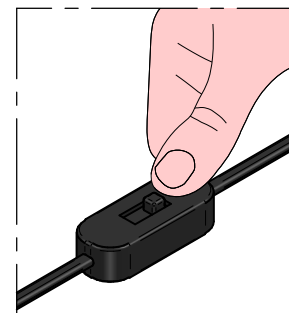
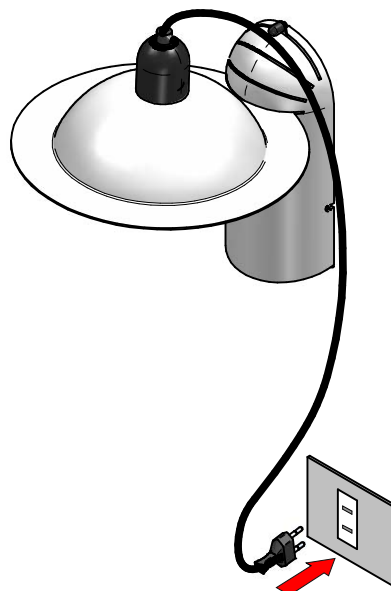

ON - OFF



LAMPIATTA
TABLE/WALL
FAMILY



E8971



E8972



E8973



9.b

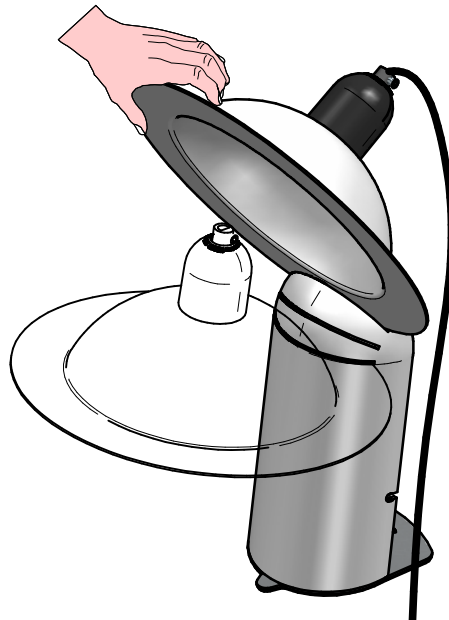
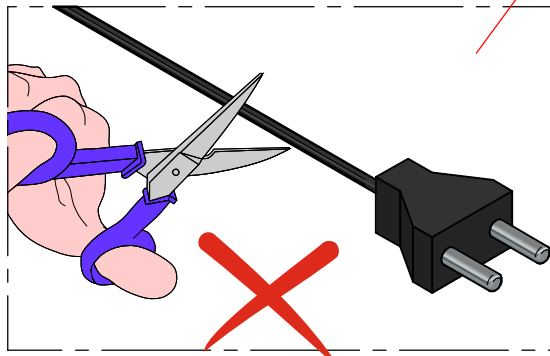
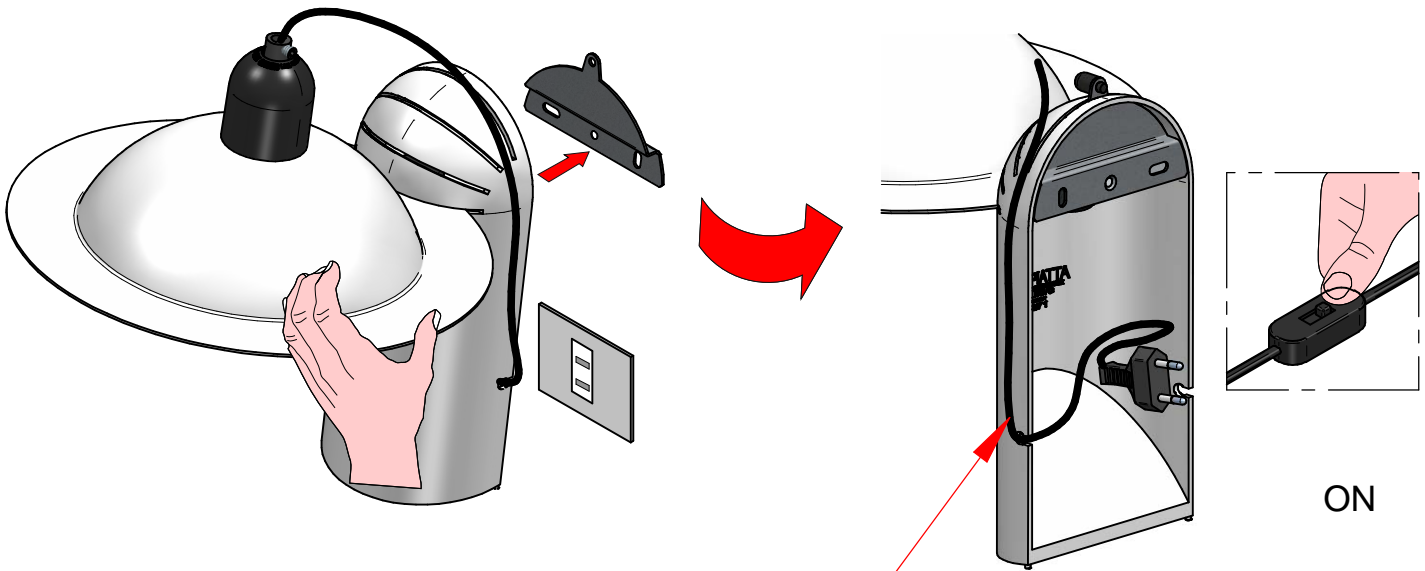

LAMPIATTA
TABLE/WALL
FAMILY

E8971



E8972



E8973

