

NUVEM SUSPENSION MODULE

Light Source: 2 X 8W GU10 PAR 16 LED Filament Bulbs

Dimmable: with dimmable bulbs

Materials: Opalflex® or Lentiflex®

With: bulbs on request

Weight: net 2,7 Kg - gross 3,1 Kg

Packaging: 100 x 107 x h. 7 cm
11 x 10 x h. 21 cm

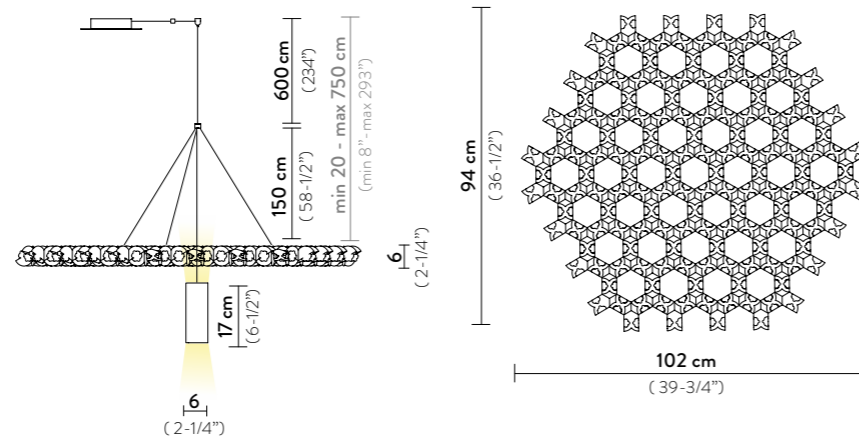

FINISH	PRODUCT CODE	EAN CODE	DETAILS
 WHITE	NUVSM00WHT06T00000EU	8024727081014	The canopy is NOT INCLUDED with the single module, sold separately. The Additional Module does NOT INCLUDE the spotlight, sold separately.
	NUVS000WHT06TNS000EU ADDITIONAL (NO SPOTLIGHT)	8024727083377	

 VELVET	NUVSM00VLV06T00000EU	8024727090344	The canopy is NOT INCLUDED with the single module, sold separately. The Additional Module does NOT INCLUDE the spotlight, sold separately.
	NUVS000VLV06TNS000EU ADDITIONAL (NO SPOTLIGHT)	8024727090337	

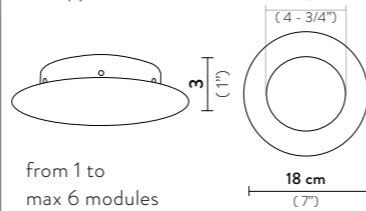
 WHITE	ACC00COP0000__NUV	8024727080994	Canopy  from 1 to max 6 modules 12 cm (4 - 3/4") 18 cm (7")
--	--------------------------	---------------	--

ADDITIONAL BIDIRECTIONAL SUSPENSION SPOTLIGHT

Light Source: 2 X 8W GU10 LED PAR 16

Dimmable: with dimmable bulbs

Materials: Steel

With: bulbs on request

Weight: net 0,5 Kg - gross 0,6 Kg

Packaging: 11 x 10 x h. 21 cm

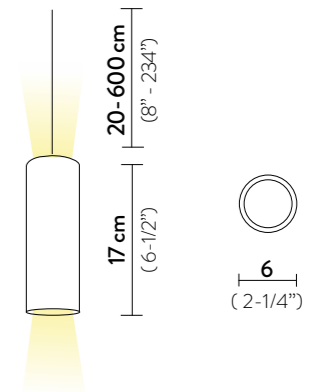

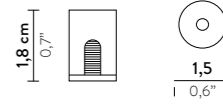
FINISH	PRODUCT CODE	EAN CODE	DETAILS
 WHITE	ACC00SPO0000__NUV WHITE	8024727081007	INCLUDED WIRE ANCHOR for ceiling attachment  1,8 cm (0,7") 1,5 cm (0,6")
	ACC00SPO0000VLNUV VELVET	8024727090962	

ADDITIONAL CEILING/WALL SPOTLIGHT

Light Source: 10W - 220~240V/24Vdc - 3.000 Lumen - 3.000 Kelvin - CRI >90, Integrated LED

Dimmable: with dimmable bulbs

Materials: Steel

With: bulbs on request

Weight: net 0,18 Kg - gross 0,2 Kg

Packaging: 8 x 8 x h. 11 cm

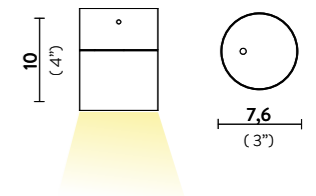

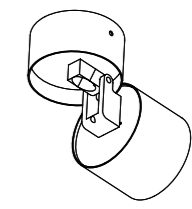
FINISH	PRODUCT CODE	EAN CODE	DETAILS
 WHITE	ACC00PLF0000W__NUV	8024727085111	

NUVEM SUSPENSION MODULE

Light Source: 2 X 8W GU10 PAR 16 LED Filament Bulbs

Dimmable: with dimmable bulbs

Materials: Opalflex® or Lentiflex®

With: bulbs on request

Weight: net 5,95 lbs - gross 6,83 lbs

Packaging: 39,37 x 42,13 x h. 2,76 in
4,33 x 3,94 x h. 8,27 in

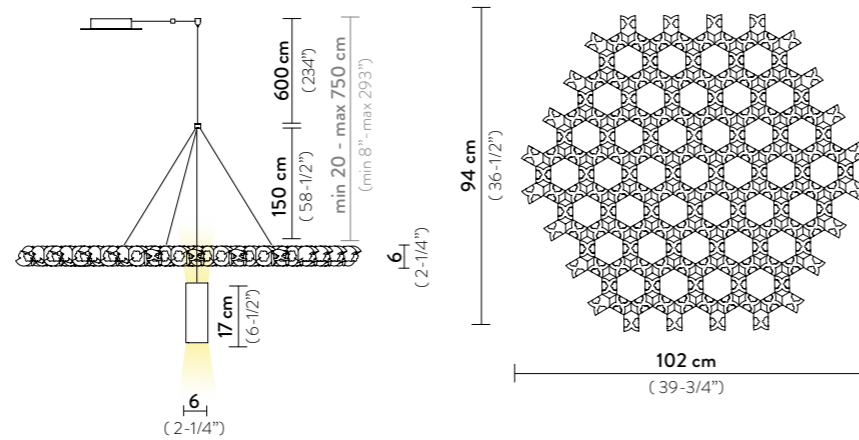

FINISH	PRODUCT CODE	EAN CODE	DETAILS
 WHITE	NUVSM00WHT06T00000US	8024727082776	The canopy is NOT INCLUDED with the single module, sold separately. The Additional Module does NOT INCLUDE the spotlight, sold separately.
	NUVS000WHT06TNS000EU ADDITIONAL (NO SPOTLIGHT)	8024727083377	

 VELVET	NUVSM00VLV06T00000US	8024727091938	The canopy is NOT INCLUDED with the single module, sold separately. The Additional Module does NOT INCLUDE the spotlight, sold separately.
	NUVS000VLV06TNS000EU ADDITIONAL (NO SPOTLIGHT)	8024727090337	

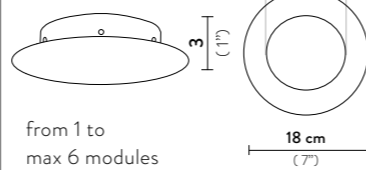
 WHITE	ACC00COP0000__NUV	8024727080994	Canopy  from 1 to max 6 modules 12 cm (4 - 3/4") 18 cm (7")
--	--------------------------	---------------	--

ADDITIONAL BIDIRECTIONAL SUSPENSION SPOTLIGHT

Light Source: 2 X 8W GU10 LED PAR 16

Dimmable: with dimmable bulbs

Materials: Steel

With: bulbs on request

Weight: net 1,1 lbs - gross 1,32 lbs

Packaging: 4,33 x 3,94 x h. 8,27 in

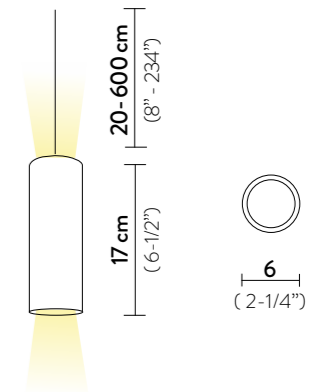

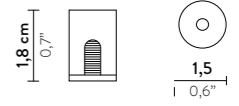
FINISH	PRODUCT CODE	EAN CODE	DETAILS
 WHITE VELVET	ACC00SPO0000__NUV WHITE	8024727081007	INCLUDED WIRE ANCHOR for ceiling attachment  1,8 cm (0,7") 1,5 cm (0,6")
	ACC00SPO0000VLNUV VELVET	8024727090962	

ADDITIONAL CEILING/WALL SPOTLIGHT

Light Source: 10W - 100-120V/24Vdc - 3.000 Lumen - 3.000 Kelvin - CRI >90, Integrated LED

Dimmable: with dimmable bulbs

Materials: Steel

With: bulbs on request

Weight: net 0,4 lbs - gross 0,44 lbs

Packaging: 3,15 x 3,15 x h. 4,33 in

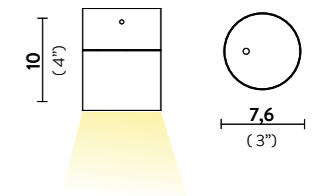

FINISH	PRODUCT CODE	EAN CODE	DETAILS
 WHITE	ACC00PLF0000W__NUV	8024727085111	