

FOREVER
SCHONBEK

SEDUCTION
SJ4328RE



THIS DESIGN IS THE PROPRIETARY
TRADE DRESS/TRADEMARK OF
W SCHONBEK LLC.

FOREVER
SCHONBEK



WWW.SCHONBEK.COM/INSTALLATIONMANUAL

All electrical components must be installed by a licensed electrician in accordance with the National Electric Code and the appropriate local electrical codes.

Fixture must be assembled per the provided instructions. Altering number of crystal modules may cause product failure and will void warranty.

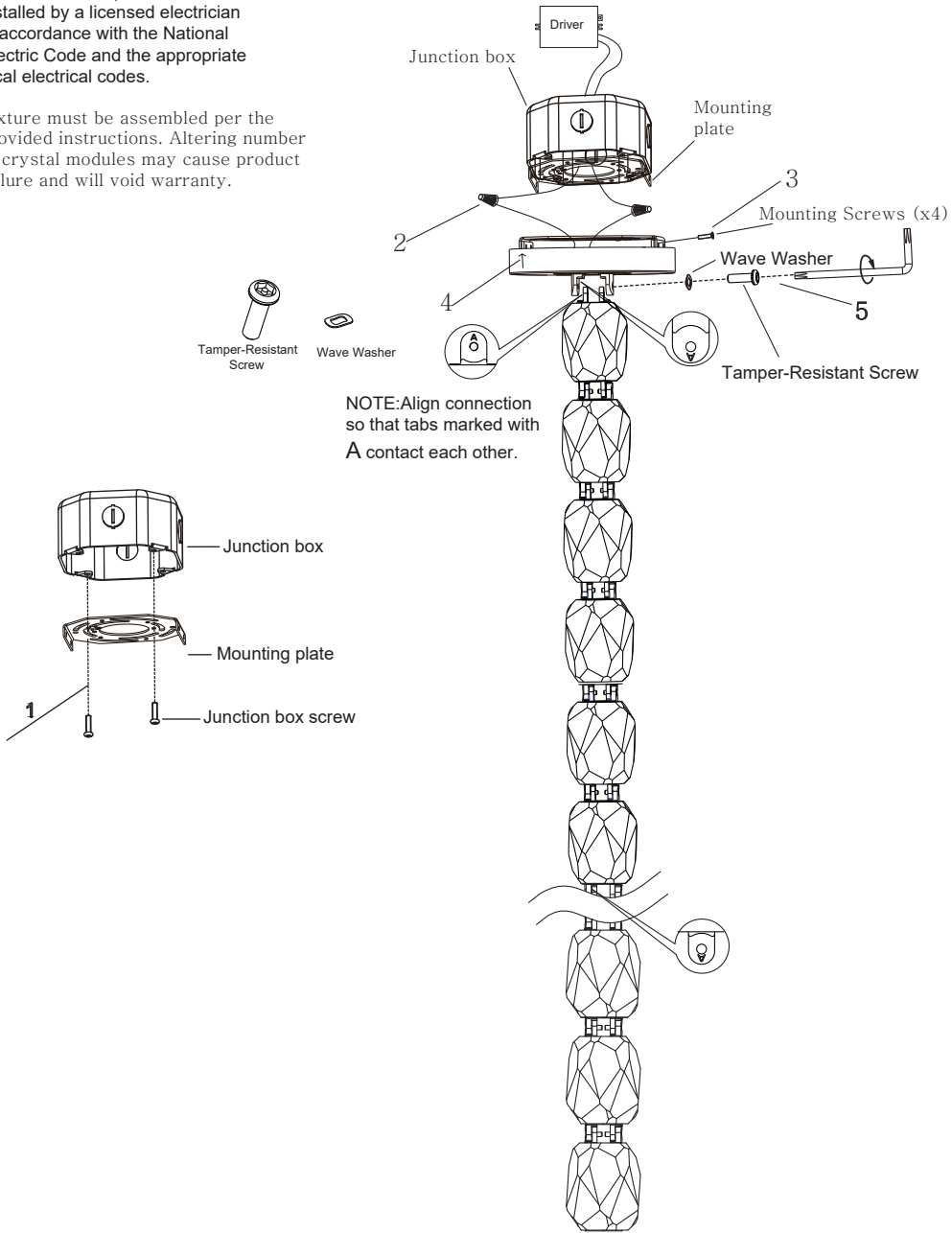

Optional Steps for Two-Canopy Structure

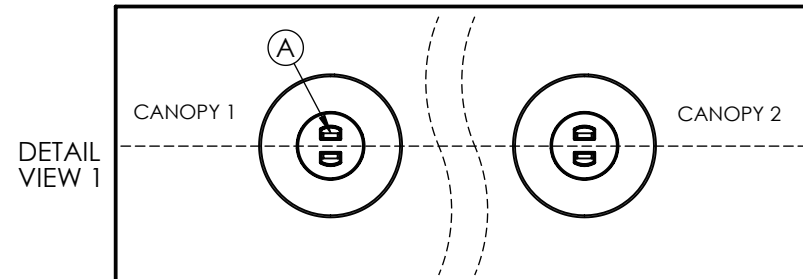
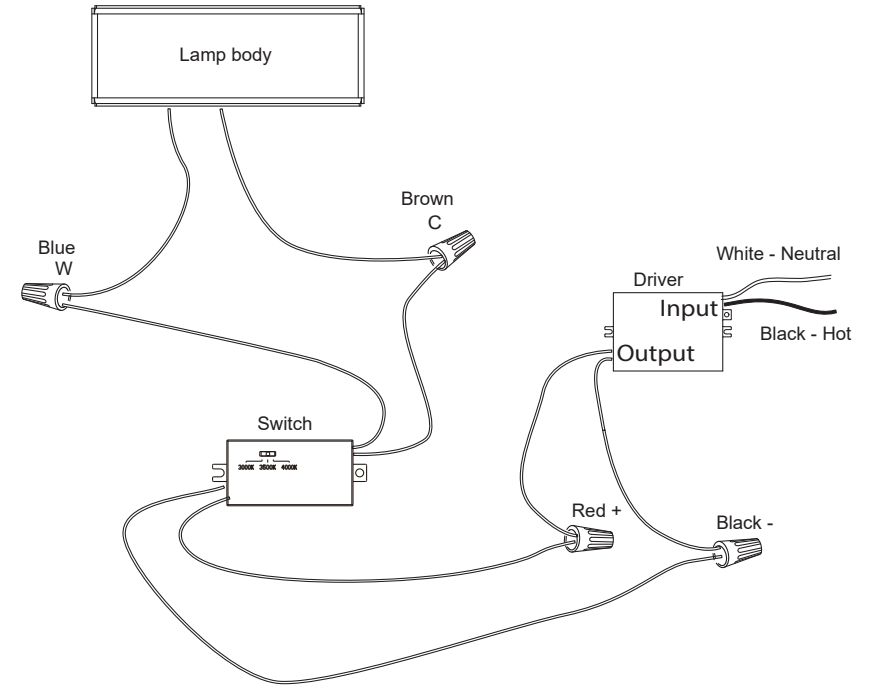
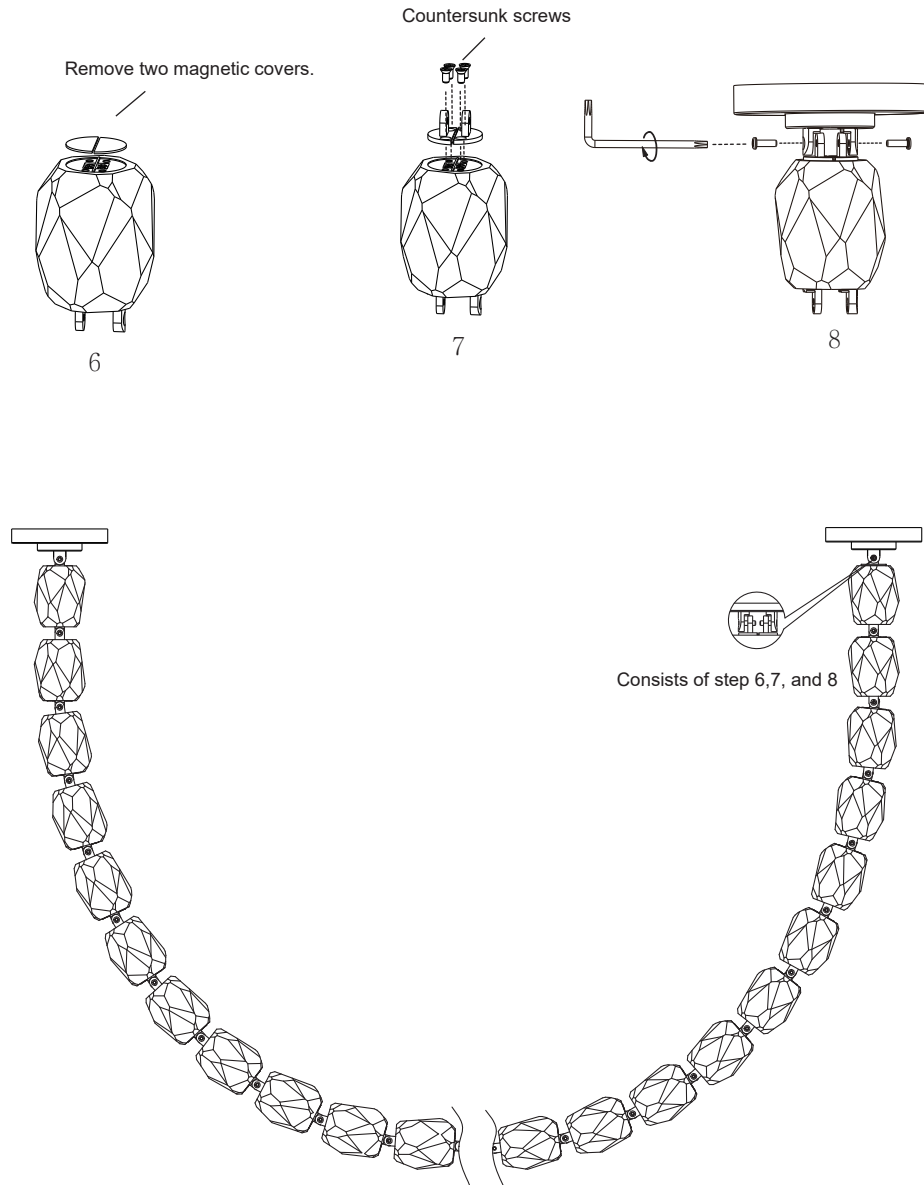

REPEAT STEPS 1-4 FOR BOTH CANOPIES. ORIENTATION MUST BE AS SHOWN IN DETAIL VIEW 1. THE TWO CANOPIES MUST BE MOUNTED IN LINE AS SHOWN.



DETAIL VIEW 2

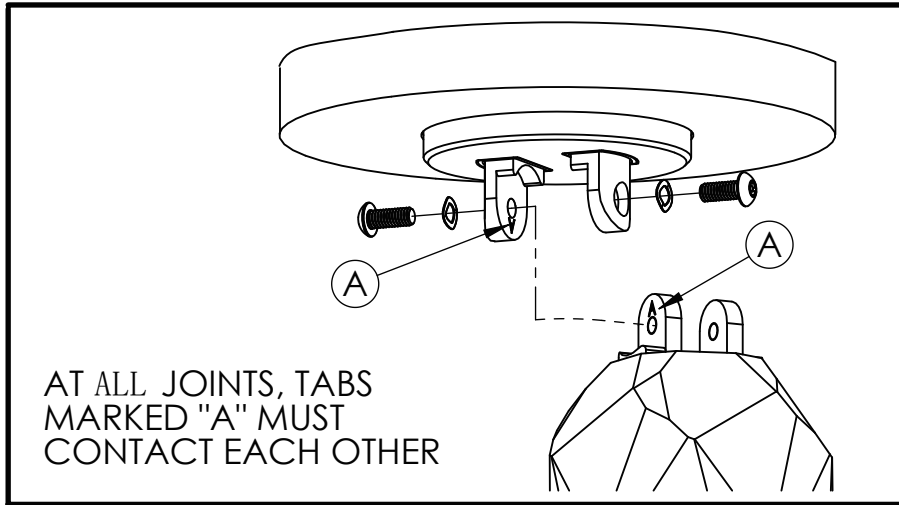

AT ALL JOINTS, TABS
MARKED "A" MUST
CONTACT EACH OTHER

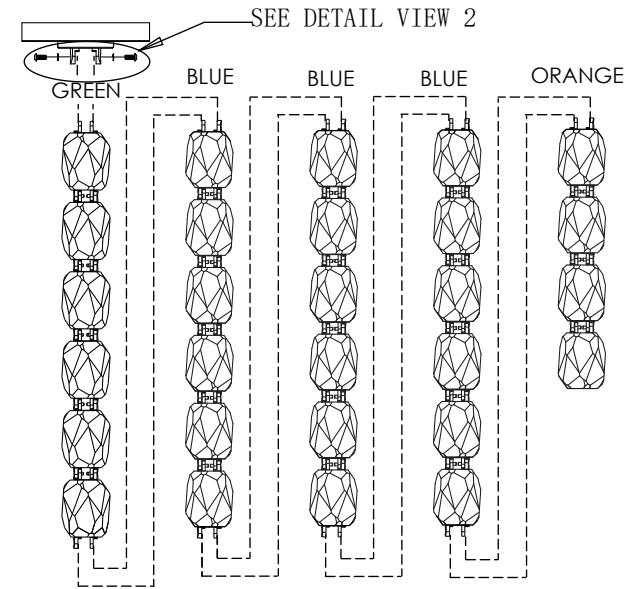

Each string of lights is identified by colored straps. Remove straps before installing. Connect sections as shown in the figure above. First, connect Green section to canopy, then attach Blue middle sections. At the end, attach Orange end section.

FULLY ASSEMBLE FIXTURE BEFORE TURNING ON POWER. TO ADJUST 3CCT SETTING, TURN OFF BEFORE ADJUSTING SWITCH.

NOTE: AT ALL JOINTS, TABS MARKED 'A'
MUST CONTACT EACH OTHER

FOREVER
SCHONBEK

SEDUCTION
SJ4328IC



THIS DESIGN IS THE PROPRIETARY
TRADE DRESS/TRADEMARK OF
W SCHONBEK LLC.

FOREVER
SCHONBEK

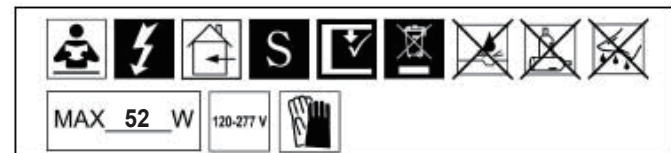

All electrical components must be installed by a licensed electrician in accordance with the National Electric Code and the appropriate local electrical codes.

Fixture must be assembled per the provided instructions. Altering number of crystal modules may cause product failure and will void warranty.

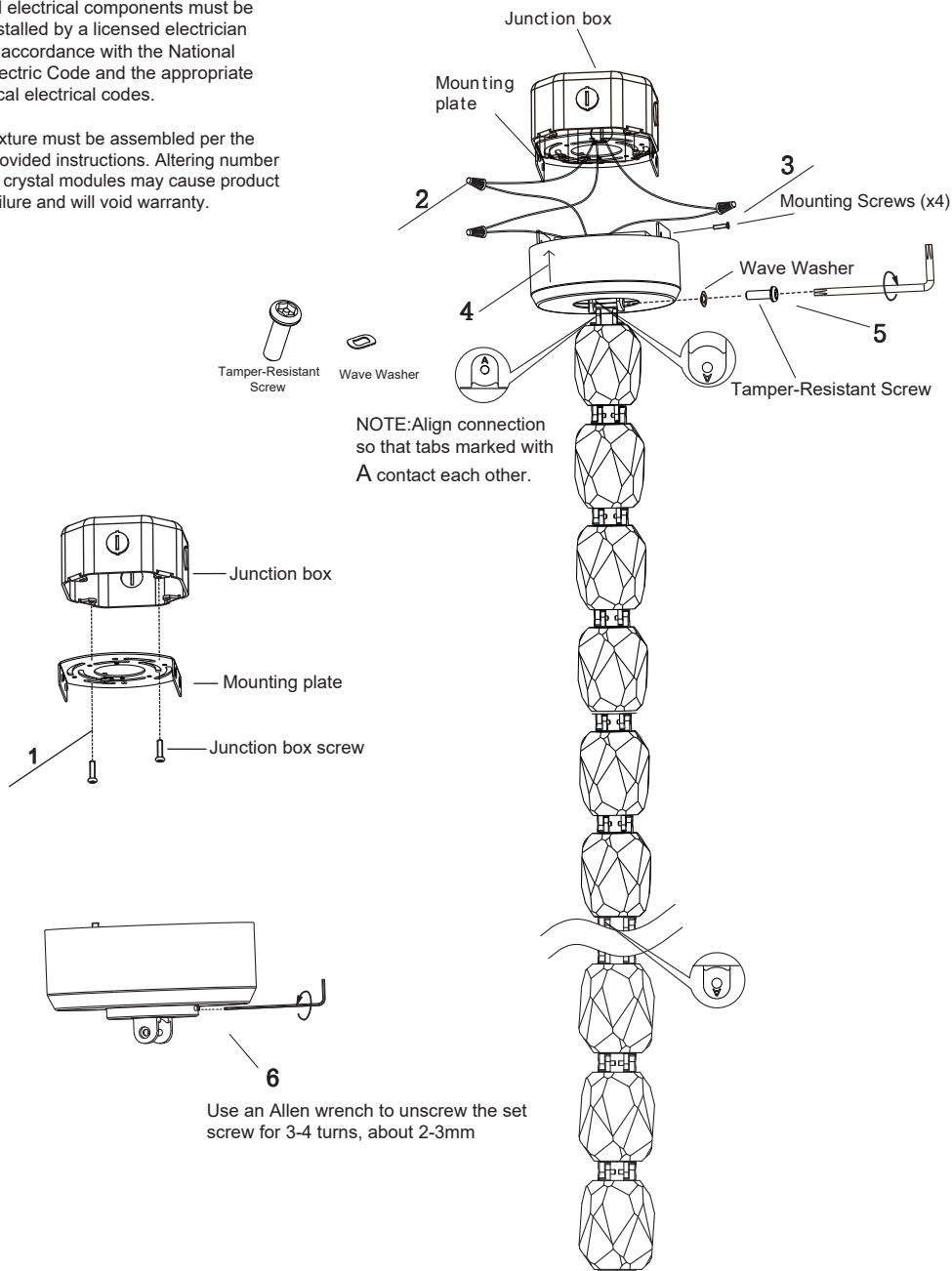

Optional Steps for Two-Canopy Structure

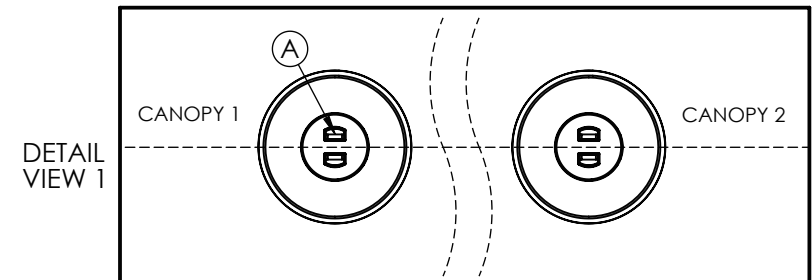
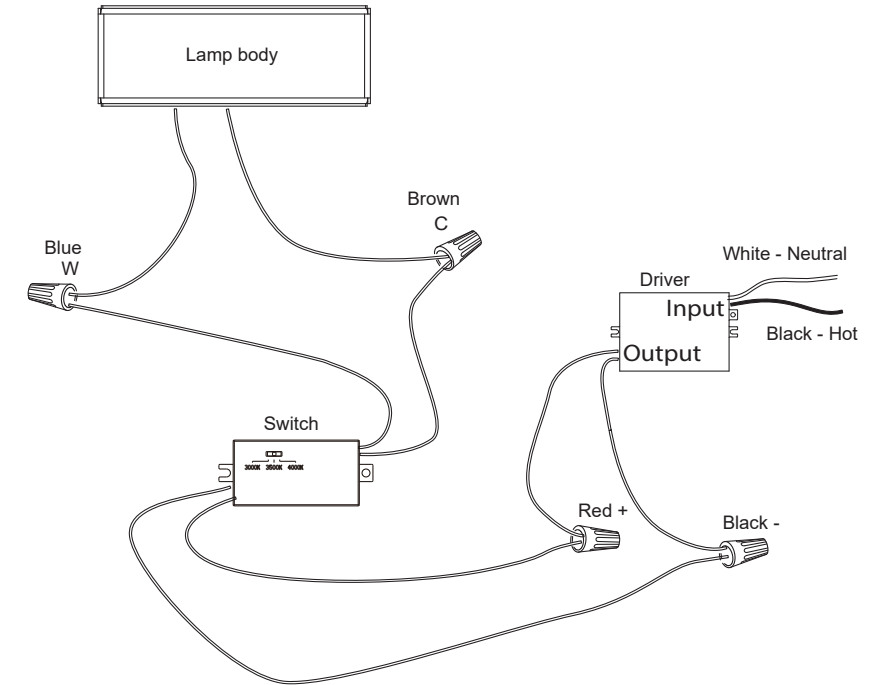
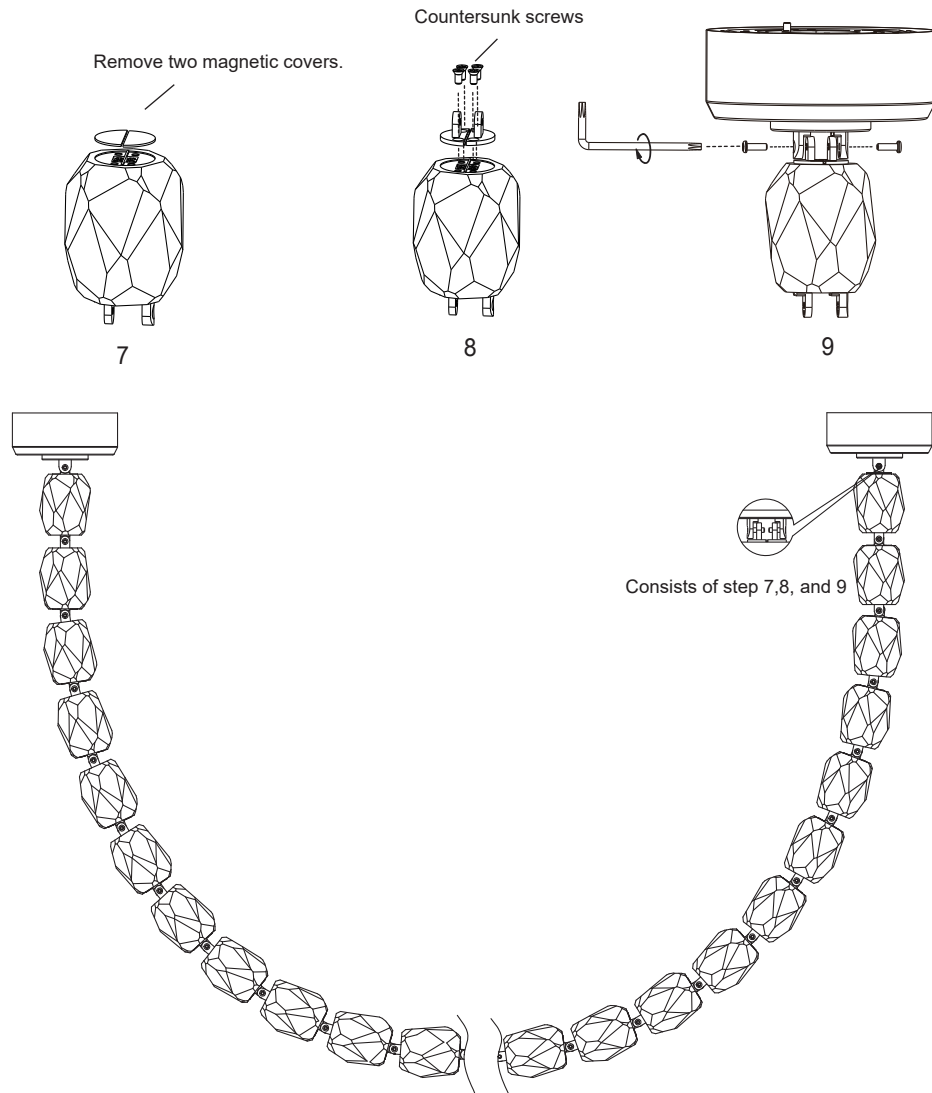

REPEAT STEPS 1-4 FOR BOTH CANOPIES. ORIENTATION MUST BE AS SHOWN IN DETAIL VIEW 1. THE TWO CANOPIES MUST BE MOUNTED IN LINE AS SHOWN.

DETAIL VIEW 2

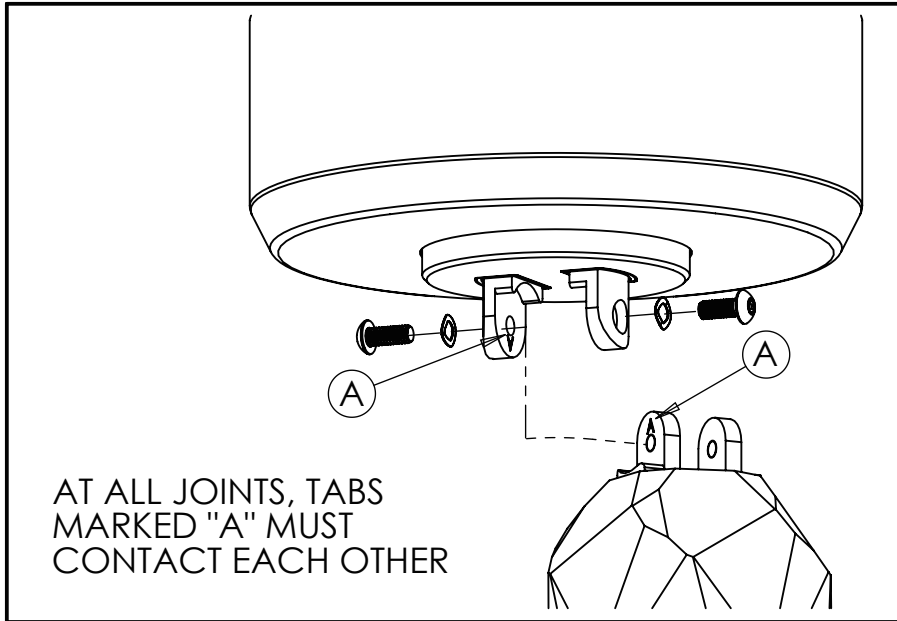

AT ALL JOINTS, TABS MARKED "A" MUST CONTACT EACH OTHER

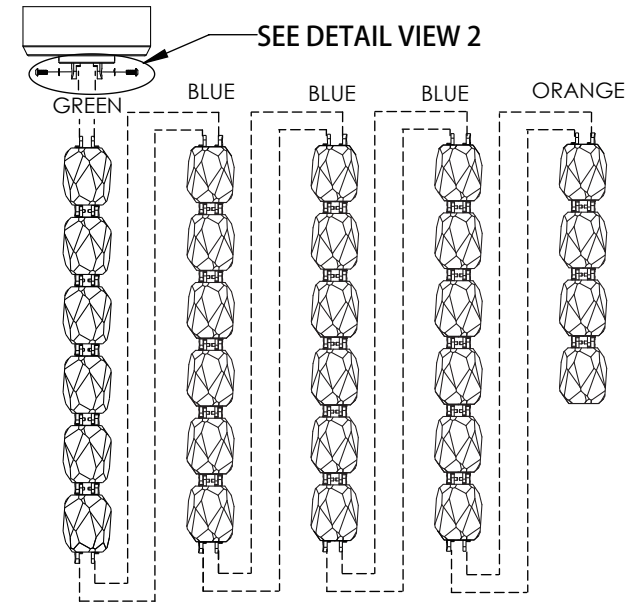

Each string of lights is identified by colored straps. Remove straps before installing. Connect sections as shown in the figure above. First, connect Green section to canopy, then attach Blue middle sections. At the end, attach Orange end section.

FULLY ASSEMBLE FIXTURE BEFORE TURNING ON POWER. TO ADJUST 3CCT SETTING, TURN OFF BEFORE ADJUSTING SWITCH.

NOTE: AT ALL JOINTS, TABS MARKED 'A' MUST CONTACT EACH OTHER