

ASSEMBLY & INSTALLATION INSTRUCTIONS

Fixture

BPD40206

SCHONBEK
Beyond

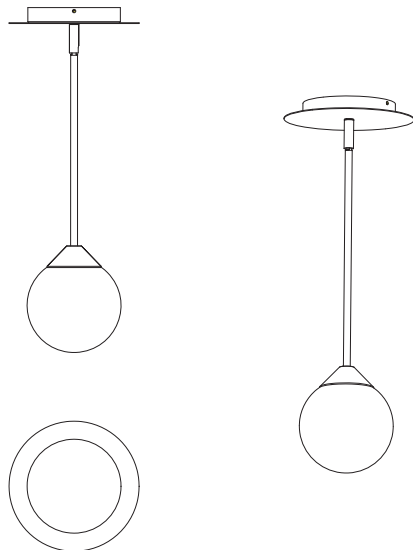

WARNING

IMPORTANT: NEVER attempt any work without shutting off the electricity.

- o Read all instructions before installing.
- o System is intended for installation in accordance with the National Electrical Code (NEC), other applicable installation code(s) and local regulations by a licensed electrician familiar with the operation of the product and the hazards involved.
- o Go to the main fuse box, or circuit breaker panel. Place the main power switch in the "OFF" position and unscrew the fuse (s) or switch "OFF" the circuit breaker switch (es) that control the power to the fixture (s) or room that you are working on.

- o Place the wall switch in the "OFF" position.
- o FAILURE TO INSTALL THIS FIXTURE IN ACCORDANCE WITH THESE INSTRUCTIONS MAY RESULT IN SERIOUS PERSONAL INJURY OR DEATH AND/OR PROPERTY DAMAGE.

CAUTION

- o All parts must be used as indicated in these instructions. Do not substitute any parts, leave parts out, or use any parts that are worn out or broken. Failure to follow this instruction could invalidate the ETL/CETL Listing of this fixture.
- o When handling the fixture, do not apply pressure to the LEDs or bulbs. Hold the fixture by the base only.
- o Do not exceed maximum wattage noted on the fixture. Use only the recommended LED or standard lamps with the fixture.

ADVERTENCIA

IMPORTANTE: NUNCA trate de hacer ningún trabajo sin desconectar la electricidad.

- o Lea todas las instrucciones antes de instalar.
- o El sistema tiene por objeto la instalación de acuerdo con el Código Eléctrico Nacional, y otros códigos de instalación y reglamentos locales aplicables, por parte de un electricista autorizado que esté familiarizado con el funcionamiento del producto y los peligros involucrados.
- o Vaya a la caja de fusibles o al panel de disyuntores principal. Ponga el interruptor principal de alimentación en la posición de "APAGADO", y desenrosque los fusibles o "DESCONECTE" los disyuntores que controlen la alimentación a los dispositivos o la habitación en los que usted esté trabajando.
- o Ponga el interruptor de pared en la posición de "APAGADO".
- o EL HECHO DE NO INSTALAR ESTE DISPOSITIVO DE ACUERDO CON ESTAS INSTRUCCIONES PODRÍA RESULTAR EN UNA LESIÓN PERSONAL GRAVE O LA MUERTE, Y/O DAÑOS A LA PROPIEDAD.

PRECAUCIÓN

- o Todas las piezas deben usarse como se indica en estas instrucciones. No sustituya ninguna pieza, no deje piezas fuera, ni utilice ninguna pieza que esté desgastada ni rota. El hecho de no seguir estas instrucciones podría invalidar la certificación ETL/CETL de este dispositivo.
- o Al manipular el dispositivo, no aplique presión a los LED ni las bombillas. Sujete el dispositivo solo por la base.
- o No exceda la potencia máxima indicada en el dispositivo. Use solo los LED o las bombillas estándar recomendados con el dispositivo.

ADVERTENCIA

IMPORTANTE: NUNCA trate de hacer ningún trabajo sin desconectar la electricidad. IMPORTANT : Ne JAMAIS entreprendre des travaux sans couper l'électricité.

- o Lire toutes les instructions avant l'installation.
- o Ce système est conçu pour être installé conformément au Code national de l'électricité ou d'autres codes d'installation et réglementations locales en vigueur par un électricien agréé connaissant le fonctionnement de ce produit et les dangers qu'il comporte.
- o Aller à la boîte à fusibles ou panneau principal de disjoncteurs. Placer l'interrupteur d'alimentation principal sur « ARRÊT » et dévisser le ou les fusibles ou mettre sur « ARRÊT » le ou les disjoncteurs qui contrôlent l'alimentation du ou des appareils électriques ou de la pièce dans laquelle vous travaillez.
- o Mettre l'interrupteur mural sur « ARRÊT ».
- o NÉGLIGER D'INSTALLER CET APPAREIL CONFORMÉMENT À CES INSTRUCTIONS RISQUE D'ENTRAÎNER DE GRAVES BLESSURES PERSONNELLES OU LA MORT AINSI QU'DES DOMMAGES MATÉRIELS.
- o MISE EN GARDE
- o Toutes les pièces doivent être utilisées comme indiqué dans ces instructions. Ne remplacer aucune pièce, ne laisser aucune pièce de côté ou n'utiliser aucune pièce usée ou cassée. Le non-respect de cette directive peut invalider l'homologation ETL/CETL de cet appareil.
- o Lors de la manipulation de cet appareil, n'appliquer aucune pression sur les DEL ou les ampoules. Maintenir l'appareil par la base uniquement.
- o Ne pas dépasser le nombre de watts maximum indiqué sur l'appareil. N'utiliser que les DEL ou ampoules standard recommandées dans cet appareil.

SCHONBEK
Beyond

Schonbek, 61 Industrial Blvd, Plattsburgh, New York 12901

Phone: 1-800-836-1892 | Fax: 518-563-4228 |

www.schonbek.com

ASSEMBLY & INSTALLATION INSTRUCTIONS

Fixture
BPD40206

SCHONBEK
Beyond

Fig. 2 Wiring

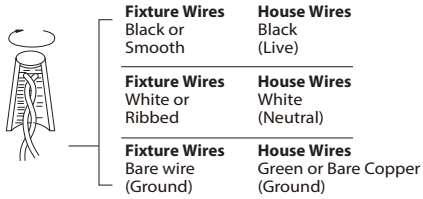
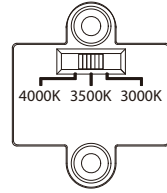

Fig. 3 Switch



CEILING PLATE

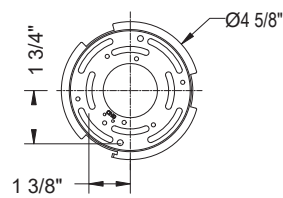

Fig. 4 Wiring

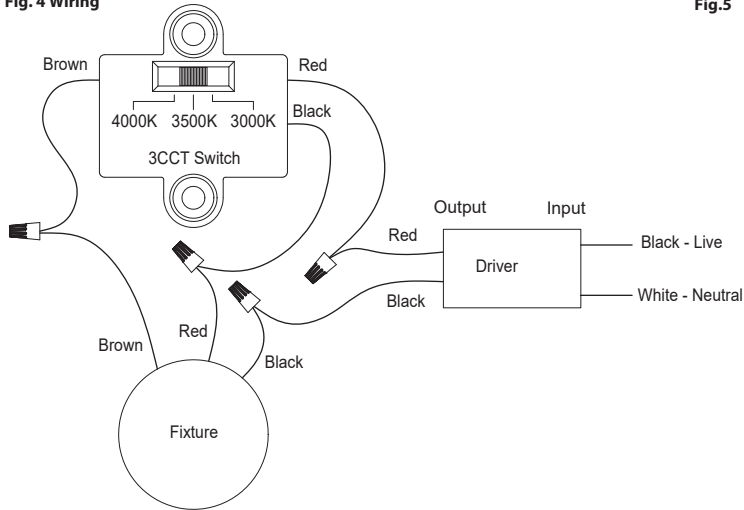
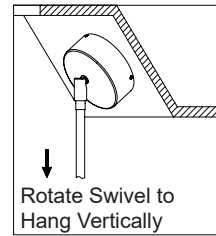

Fig. 5



HARDWARE

A



Wire Connector
Qty: 3pcs+ Extra

B



Wire Connector, Small
Qty: 4pcs+ Extra

C



Canopy Screw
Qty: 1 Extra

ASSEMBLY & INSTALLATION INSTRUCTIONS

Fixture
BPD40206

SCHONBEK
Beyond

Fig. 1

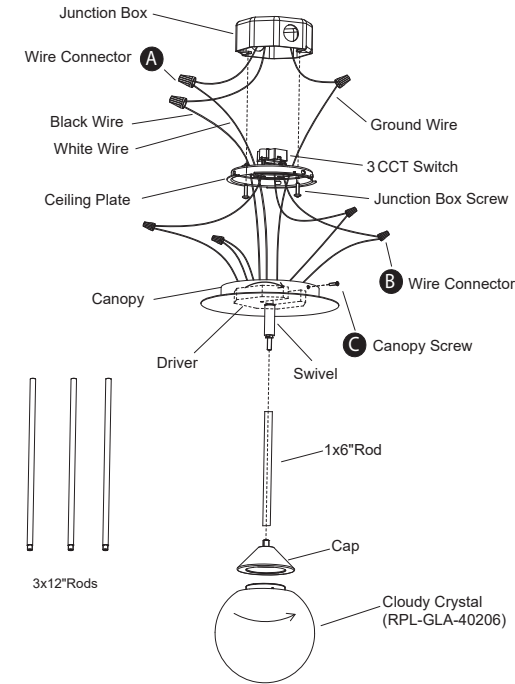

To Install Fixture (Fig. 1)

CAUTION: BE SURE POWER IS OFF AT THE MAIN BREAKER BOX PRIOR TO INSTALLATION.

PREPARATION

- Shut off the power at the circuit breaker and remove existing fixture, including the crossbar.
- Carefully unpack your new fixture and lay out all the parts on a clear area. Be careful not to lose any small parts necessary for installation.

MOUNTING THE FIXTURE (Fig. 1)

- Remove the canopy screw (C) from the mounting plate.
- The lamp can switch between three color temperatures (3000K-3500K-4000K), which can be adjusted to your preference with the switch on the ceiling plate (Fig.3).
*Requires switch to be recessed within the junction box.
- Secure the mounting plate to the junction box using the screws provided with the junction box.
Note: (i) Use only original junction box screws or junction box manufacturer's replacement screws.
(ii) The side of the mounting plate marked "GND" must face out.

- Choose the number of the rods suitable for your application. Thread the fixture wire through the rods, swivel and canopy. Connect the fixture, rods and swivel. Make sure all are tightened.

CONNECTING THE WIRES (Fig. 2)

- Connect the driver's output wires, fixture's wires and 3 CCT switch's wires together using wire connectors (B) as shown in Fig. 4.
- Connect the driver's input wires to junction box as shown in Fig. 2. Making sure that all wire connectors (A) are secured. If your outlet box has a green or bare copper ground wire, connect the fixture's ground wire to it. After wires are connected, tuck them carefully inside the junction box.

COMPLETING THE INSTALLATION

- Turn and rotate the canopy in the direction of the arrow until it stops. Fasten the canopy to the ceiling back plate using the canopy screw (C).
- Rotate the cloudy crystal into the cap.
- For slope ceiling applications, rotate swivel at the top of the stem to ensure luminaire is aiming down (Fig.5).