

TUBO LARGE

24VDC TRACK HEAD WITH INTEGRATED LED, STATIC WHITE & WARM DIM TECHNOLOGY

DESIGNED BY GREGORY KAY | ASSEMBLED IN AMERICA

REV 03.15.22



T24-TUBL-SP-30K-WH



T24-TUBL-SP-30K-BK

DESCRIPTION

The Tubo Large Track Head is a 15-watt track luminaire that delivers up to 1032 lumens making the most out of ceiling space while exhibiting a simple yet appealing modern design. Being part of an entirely Low Voltage 24VDC system, it offers unsurpassed efficiency in comparison to traditional track lighting systems. The cylindrical flat-back design houses the heat-sink, LED module, and integrated driver offering 360° horizontal rotation and 90° vertical aiming. Available in five Color Temperatures including Warm Dim (**30D**), that dims from 3000K-1800K exhibiting designer-grade color rendering as high as 98 CRI and R9-90. Choose from four different beam spreads as well as lens accessories including field-changeable, optic reflectors. With every element designed to be slender and unobtrusive, the Tubo Large provides superb illumination and functionality within a small package.

MOUNTING OPTIONS

Compatible with TruTrack Recessed Track (**TR24-1C**, **TR24-2C**) Pipeline Systems including Modular Suspension, Pipeline Track Suspension with Up Light and Pipeline Stem Mount Wall/Display (**P1SDM**, **PT**, **PSTU2CR**, **PSTU2CR**) and Surface Mount track (**TS24-1C**)

REMOTE POWER SUPPLIES (SOLD SEPARATELY)

24VDC, Class 2 wiring

- [UNI Driver: Universal Dimming \(TRIAC, ELV, 0-10V\)](#)

DIMMING

- Compatible with Lutron Diva, Skylark and Legrand 0-10 Volt dimmers
- Dimmable to 1%, Flicker less than 2%

LAMPING

BEAM ANGLE REFERENCE 45°					
COLOR TEMPERATURE	24K	27K	30K	30D	35K
TOTAL LUMENS	1032	920	891	683	1024
WATTS	14	14	14	14	14
LUMENS PER WATT (lm/w)	74	66	65	49	73
CRI	97	92	92	97	97.5
TM-30 DATA	R9: 60 Rf: 93 Rg: 98	R9: 97 Rf: 92 Rg: 100	R9: 64 Rf: 91 Rg: 98	R9: 90 Rf: 95 Rg: 102	R9: 92 Rf: 94 Rg: 101
LAMP LIFE	60,000 Hours, 70% Lumen Maintenance				

ACCESSORIES

Field changeable lenses in **NS** (10°), **SP** (20°), **NF** (35°), **FL** (45°), **VW** (75°) beam spread options

APPLICATIONS

Designed for indoor use only, dry and damp locations. Ideal applications in Commercial, Retail, Residential, Hospitality, Education, and Healthcare Institutions.

WARRANTY / LABELS

Pro-rated 5 year warranty. Assembled in America, ETL (Conforms to UL1598 and CSA 22.2 #250.0) RoHs, Title 24 JA8 with universal power supplies in 27K> CCT.

FINISHES

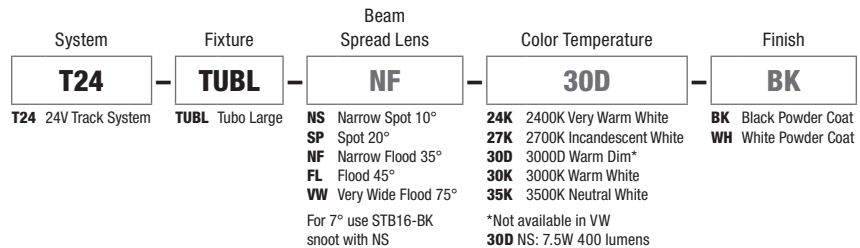
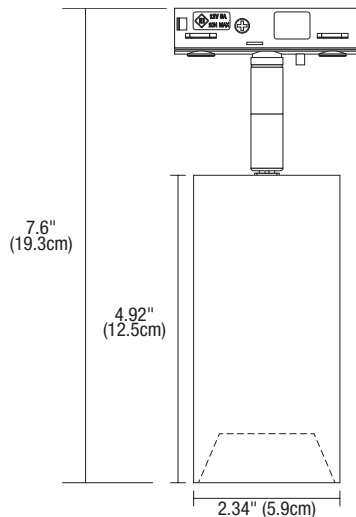
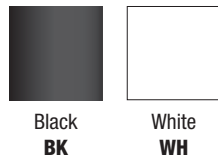





PROJECT	FIXTURE TYPE	DATE
---------	--------------	------

TUBO LARGE

24VDC TRACK HEAD WITH INTEGRATED LED, STATIC WHITE & WARM DIM TECHNOLOGY

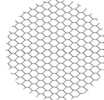
Additional Lenses and Accessories

TUBO LARGE LENS		SNOOT		LOUVER	FOCUS LENS	LINEAR SPREAD FILM	
							
ORDERING CODE	STATIC WHITE LEN-TUBL-SP-SW LEN-TUBL-NF-SW LEN-TUBL-FL-SW LEN-TUBL-VW-SW	WARM DIM LEN-TUBL-SP-WD LEN-TUBL-NF-WD LEN-TUBL-FL-WD	STB16-BK STB16-WH (WHITE SHELL)	ST16-BK ST16-WH	LO16-H	LF-TUBL-SF (SOFT FOCUS), MF (MEDIUM FOCUS), WF (WIDE FOCUS)	LF-TUBL-LS
	LENS SIZE 2" (50mm) Diameter		BEAM SPREADS SP (20°), NF (35°) FL (45°), VW (75°)	Conical snoot creates a 7° Beam spread and is designed to reduce spill and control glare. Spun aluminum.	Snoot is designed to reduce spill and control glare. Spun aluminum.	Hexcell louver eliminates glare. 0.125" Thickness.	Soft focus lens is included with every track head. Diffuses the beam, providing uniform illumination.

TUBO LARGE Photometric Data

NARROW SPOT BEAM ANGLE 10°

D'	FC	DIA.
1'	17300	2.2"
2'	4330	4.3"
3'	1930	6.5"
4'	1080	8.6"
5'	694	10.8"
6'	482	12"
7'	354	15"
8'	271	18"

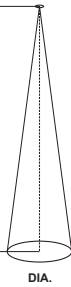

SPOT BEAM ANGLE 20°

D'	FC	DIA.
1'	2582	4.3"
2'	1860	8.6"
3'	828	13"
4'	466	17.3"
5'	298	21.6"
6'	207	25.9"
7'	152	30.2"
8'	117	34.6"

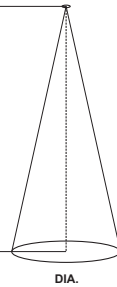

NARROW FLOOD BEAM ANGLE 35°

D'	FC	DIA.
1'	2780	7.6"
2'	695	15.1"
3'	309	22.7"
4'	174	30"
5'	111	37.2"
6'	77.2	45.4"
7'	56.7	53"
8'	43.4	62.5"

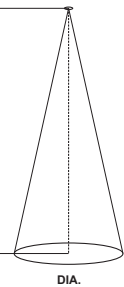

FLOOD BEAM ANGLE 45°

D'	FC	DIA.
1'	1610	9.8"
2'	403	18"
3'	179	29.2"
4'	101	40"
5'	64.5	48"
6'	44.8	58.3"
7'	32.9	68"
8'	25.2	80"

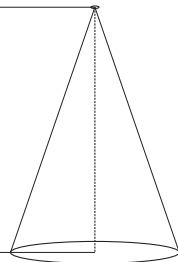

VERY WIDE FLOOD BEAM ANGLE 75°

D'	FC	DIA.
1'	561	16.2"
2'	140	32.4"
3'	62.3	48"
4'	35	64.8"
5'	22.4	81"
6'	15.6	97.2"
7'	11.4	113.4"
8'	8.8	129.6"

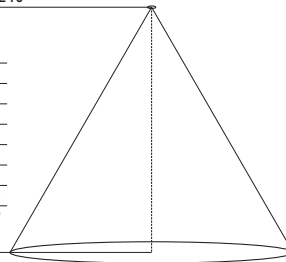

PROJECT		FIXTURE TYPE		DATE	
---------	--	--------------	--	------	--

TM30 DATA

24VDC TRACK HEAD WITH INTEGRATED LED, STATIC WHITE & WARM DIM TECHNOLOGY

TM-30-15 DATA: The data below is for Tubo. Consistent color temperatures among multiple track heads is possible through a 3 phase binning process in which each order is inspected with a color meter to ensure uniformity.

2400K | Rf: 91.2 | Rg: 96.8

Color Vector Graphic

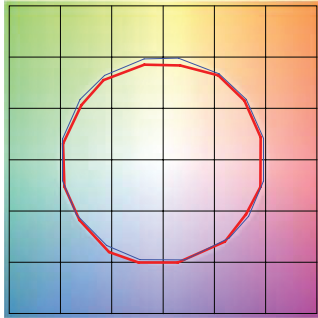

■ Test ■ Reference

GRAPHIC SHIFTS %			
HUE BIN	Rf	CHROMA	HUE
1	92.0	-2.4%	1.5%
2	94.7	-2.1%	0.0%
3	95.4	-1.9%	-0.1%
4	88.7	-6.7%	-3.1%
5	92.8	-5.6%	1.0%
6	92.7	-3.4%	3.4%
7	89.9	-4.3%	4.1%
8	92.4	-1.4%	4.4%
9	89.0	-0.6%	5.8%
10	88.9	0.4%	6.2%
11	89.7	4.0%	5.4%
12	92.6	3.0%	-0.7%
13	90.9	1.1%	-7.0%
14	89.9	0.5%	-5.8%
15	92.1	-3.2%	0.1%
16	88.9	-1.7%	-6.3%

2700K | Rf: 87.7 | Rg: 96.1

Color Vector Graphic

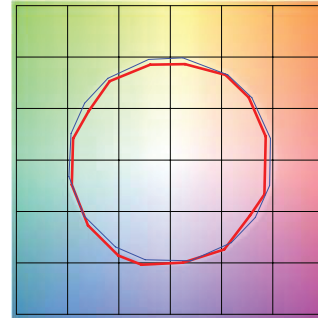

■ Test ■ Reference

GRAPHIC SHIFTS %			
HUE BIN	Rf	CHROMA	HUE
1	88.0	-4.3%	2.6%
2	91.6	-2.4%	2.0%
3	93.7	-1.4%	1.9%
4	88.9	-5.6%	-3.1%
5	92.3	-5.5%	-0.5%
6	92.9	-3.5%	0.1%
7	84.5	-7.5%	4.6%
8	90.8	-3.0%	4.4%
9	84.5	-1.3%	8.3%
10	83.9	2.0%	9.8%
11	87.2	5.3%	7.1%
12	89.2	5.4%	-2.6%
13	88.7	0.3%	-7.8%
14	86.8	1.7%	-9.3%
15	87.6	-5.4%	-1.3%
16	83.6	-3.3%	-9.5%

3000K | Rf: 88.1 | Rg: 99.7

Color Vector Graphic

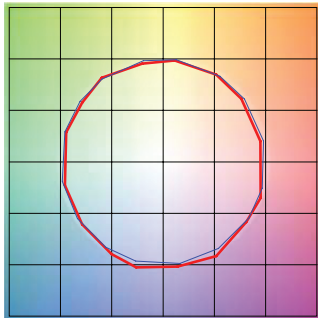

■ Test ■ Reference

GRAPHIC SHIFTS %			
HUE BIN	Rf	CHROMA	HUE
1	92.5	-3.1%	0.3%
2	93.3	-2.3%	1.9%
3	90.9	-0.8%	3.9%
4	94.3	-1.1%	1.4%
5	92.5	-2.6%	1.5%
6	96.4	1.2%	-0.3%
7	92.6	-2.5%	-0.0%
8	96.9	-1.4%	0.2%
9	92.3	-1.8%	4.3%
10	86.6	-0.7%	7.0%
11	86.5	2.4%	8.2%
12	89.8	5.9%	1.7%
13	93.9	2.6%	-2.7%
14	89.4	5.1%	-5.8%
15	90.1	-0.1%	-4.7%
16	86.5	0.3%	-9.7%

3500K | Rf: 86.1 | Rg: 95.5

Color Vector Graphic

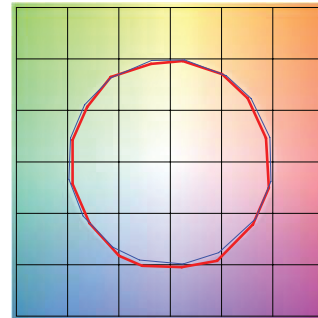

■ Test ■ Reference

GRAPHIC SHIFTS %			
HUE BIN	Rf	CHROMA	HUE
1	90.8	-3.8%	0.3%
2	92.3	-2.8%	2.1%
3	89.7	-1.0%	4.3%
4	92.6	-1.4%	1.7%
5	91.8	-3.1%	1.3%
6	96.2	0.8%	-0.4%
7	92.9	-3.2%	0.2%
8	94.3	-2.5%	1.5%
9	90.4	-2.5%	5.2%
10	84.3	-1.4%	9.5%
11	83.1	3.5%	9.8%
12	88.2	4.8%	3.4%
13	94.0	2.7%	-2.0%
14	88.7	5.9%	-5.8%
15	88.7	0.7%	-5.9%
16	86.8	-0.7%	-6.7%

3000D | Rf: 89.8 | Rg: 101.4

Color Vector Graphic

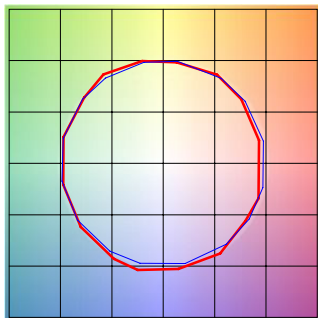

■ Test ■ Reference

GRAPHIC SHIFTS %			
HUE BIN	Rf	CHROMA	HUE
1	90.2	-4.2%	1.5%
2	90.9	-2.0%	3.7%
3	87.9	0.8%	5.5%
4	92.1	-0.9%	0.6%
5	93.0	1.5%	1.6%
6	92.2	3.9%	-0.2%
7	92.1	-0.3%	-2.0%
8	96.7	0.0%	-1.2%
9	92.5	-0.6%	3.7%
10	88.3	1.1%	7.0%
11	87.2	4.1%	7.4%
12	87.2	6.7%	-1.0%
13	88.2	3.8%	-7.2%
14	85.3	4.3%	-9.9%
15	90.9	-2.2%	-3.6%
16	83.4	-2.2%	-11.2%

PROJECT	FIXTURE TYPE	DATE
---------	--------------	------