

# TUBO SMALL TRACK DOWNLIGHT

## 24VDC INTEGRATED LED, STATIC WHITE & WARM DIM TECHNOLOGY

DESIGNED BY GREGORY KAY | ASSEMBLED IN AMERICA

REV 12.05.22



T24-TUBSD-SP-30K-WH



T24-TUBSD-SP-30K-BK

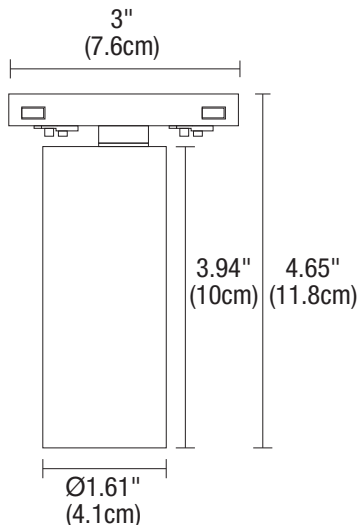

### DESCRIPTION

The Tubo Small Downlight is an 9-watt track luminaire that delivers up to 515 lumens making the most out of ceiling space while exhibiting a simple yet appealing modern design. Being part of an entirely Low Voltage 24VDC system, it offers unsurpassed efficiency in comparison to traditional track lighting systems. The cylindrical flat-back design houses the heat-sink, LED module, and integrated driver within die-cast aluminum to help dissipate heat and improve life. Available in five Color Temperatures including Warm Dim (**30D**), that dims from 3000K-1800K exhibiting designer-grade color rendering as high as 98 CRI and R9-92. Choose from four different beam spreads as well as lens accessories including field-changeable, optic reflectors. With every element designed to be slender and unobtrusive, the Tubo Small Downlight provides superb illumination and functionality within a small package.

### MOUNTING OPTIONS

Compatible with TruTrack Recessed Track (**TR24**) Pipeline Systems including Modular Suspension, Pipeline Track Suspension with Up Light and Pipeline Stem Mount Wall/Display (**P1SDM, PT, PSTU2CR, PSTU2CR**) and Surface Mount track (**TS24**)

### REMOTE POWER SUPPLIES (SOLD SEPARATELY)

24VDC, Class 2 wiring

- [Pure Smart™ WiZ Pro Power Supplies & Controls](#)
- [UNI Driver](#): Universal Dimming (**TRIAC, ELV, 0-10V**)

### DIMMING

- Compatible with Lutron Diva, Skylark and Legrand 0-10 Volt dimmers
- Dimmable to 1%, Flicker less than 2%

### LAMPING

COLOR TEMPERATURE	BEAM ANGLE REFERENCE 45°				
	24K	27K	30K	30D	35K
TOTAL LUMENS	503	420	434	287	515
WATTS	9	9	9	8	9
LUMENS PER WATT (lm/w)	59	49	51	39	61
CRI	97	92	93	94	98
TM-30 DATA	R9: 60 Rf: 93 Rg: 98	R9: 97 Rf: 92 Rg: 100	R9: 64 Rf: 91 Rg: 98	R9: 90 Rf: 95 Rg: 102	R9: 92 Rf: 94 Rg: 101
LAMP LIFE	60,000 Hours, 70% Lumen Maintenance				

### ACCESSORIES

Field adjustable single optic reflectors produce a smooth uniform beam at **NS** (15°), **SP** (25°), **NF** (35°), **FL** (45°), **VW** (75°) beam spread options

### APPLICATIONS

Designed for indoor use only, dry and damp locations. Ideal applications in Commercial, Retail, Residential, Hospitality, Education, and Healthcare Institutions.

### WARRANTY / LABELS

Pro-rated 5 year warranty. Assembled in America, ETL (Conforms to UL1598 and CSA 22.2 #250.0) RoHs , JAB listed with universal power supplies in 27K> CCT.

### FINISHES

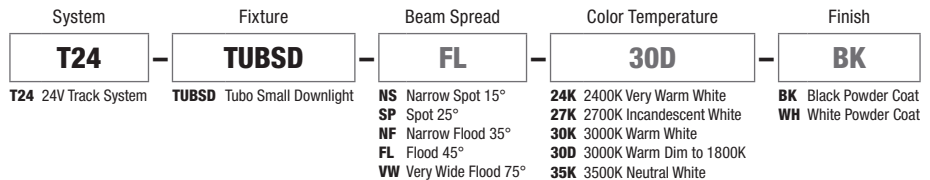
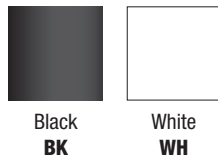





PROJECT	FIXTURE TYPE	DATE
---------	--------------	------

# TUBO SMALL TRACK DOWNLIGHT

24VDC INTEGRATED LED, STATIC WHITE & WARM DIM TECHNOLOGY

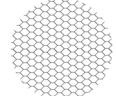
## ADDITIONAL LENSES & ACCESSORIES

	TUBO SMALL LENS	SNOOT	LOUVER	FOCUS LENS	LINEAR SPREAD FILM
					
<b>ORDERING CODE</b>	<b>STATIC WHITE</b> LEN-TUBS-NS-SW LEN-TUBS-SP-SW LEN-TUBS-NF-SW LEN-TUBS-FL-SW LEN-TUBS-VW-SW  <b>WARM DIM</b> LEN-TUBS-NS-WD LEN-TUBS-SP-WD LEN-TUBS-FL-WD LEN-TUBS-VW-WD	<b>TUBS-ST-BK</b> <b>TUBS-ST-WH (WHITE SHELL)</b>	<b>L016-H</b>	<b>LF-TUBS-SF (SOFT FOCUS),</b> <b>MF (MEDIUM FOCUS),</b> <b>WF (WHITE FOCUS)</b>	<b>LF-TUBS-LS</b>
<b>LENS SIZE</b>	1.375" (35mm) Diameter				
<b>BEAM SPREADS</b>	<b>NS (15°), SP (25°), NF (35°),</b> <b>FL (45°), VW (75°)</b>	Conical snoot creates a 7° Beam spread and is designed to reduce spill and control glare. Spun aluminum.	Hexcell louver eliminates glare. 0.125" Thickness.	Soft focus lens is included with every track head. Diffuses the beam, providing uniform illumination.	Linear spread film: directs the light into an elongated beam. Typical applications using 10°, 15°, 25° include illuminating landscape oriented art. 35°, 40°, 60° create an elongated oval typically used for wall washing.

## TUBO SMALL Photometric Data at 3000K

**D** - Distance from fixture  
**FC** - Initial foot candles at the center of beam  
**DIA** - Diameter

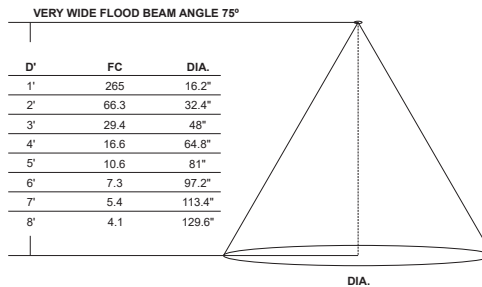
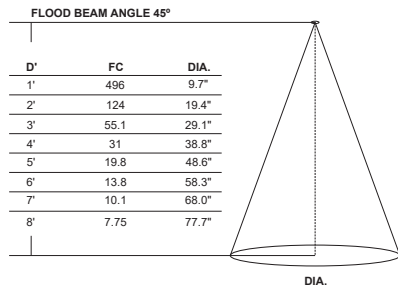
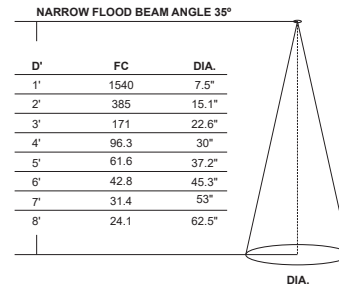
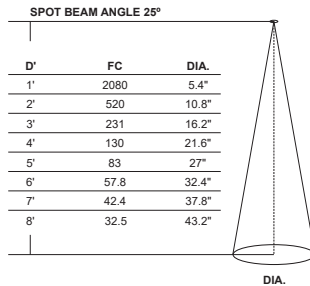
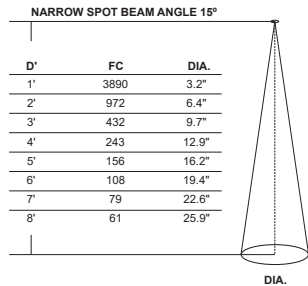

PROJECT		FIXTURE TYPE		DATE	
---------	--	--------------	--	------	--

# TM30 DATA

## 24VDC INTEGRATED LED, STATIC WHITE & WARM DIM TECHNOLOGY

**TM-30 DATA:** The data below is for Tubo Downlight. Consistent color temperatures among multiple track heads is possible through a 3 phase binning process in which each order is inspected with a color meter to ensure uniformity.

**2400K** | Rf: 91.2 | Rg: 96.8

Color Vector Graphic

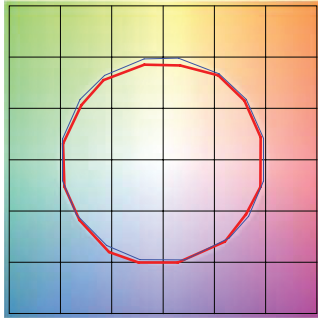

■ Test ■ Reference

HUE BIN	Rf	GRAPHIC SHIFTS %	
		CHROMA	HUE
1	92.0	-2.4%	1.5%
2	94.7	-2.1%	0.0%
3	95.4	-1.9%	-0.1%
4	88.7	-6.7%	-3.1%
5	92.8	-5.6%	1.0%
6	92.7	-3.4%	3.4%
7	89.9	-4.3%	4.1%
8	92.4	-1.4%	4.4%
9	89.0	-0.6%	5.8%
10	88.9	0.4%	6.2%
11	89.7	4.0%	5.4%
12	92.6	3.0%	-0.7%
13	90.9	1.1%	-7.0%
14	89.9	0.5%	-5.8%
15	92.1	-3.2%	0.1%
16	88.9	-1.7%	-6.3%

**2700K** | Rf: 87.7 | Rg: 96.1

Color Vector Graphic

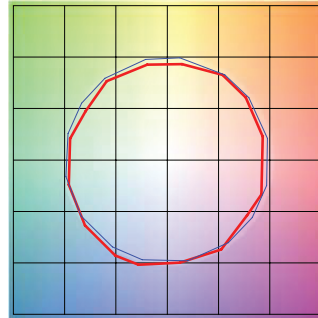

■ Test ■ Reference

HUE BIN	Rf	GRAPHIC SHIFTS %	
		CHROMA	HUE
1	88.0	-4.3%	2.6%
2	91.6	-2.4%	2.0%
3	93.7	-1.4%	1.9%
4	88.9	-5.6%	-3.1%
5	92.3	-5.5%	-0.5%
6	92.9	-3.5%	0.1%
7	84.5	-7.5%	4.6%
8	90.8	-3.0%	4.4%
9	84.5	-1.3%	8.3%
10	83.9	2.0%	9.8%
11	87.2	5.3%	7.1%
12	89.2	5.4%	-2.6%
13	88.7	0.3%	-7.8%
14	86.8	1.7%	-9.3%
15	87.6	-5.4%	-1.3%
16	83.6	-3.3%	-9.5%

**3000K** | Rf: 88.1 | Rg: 99.7

Color Vector Graphic

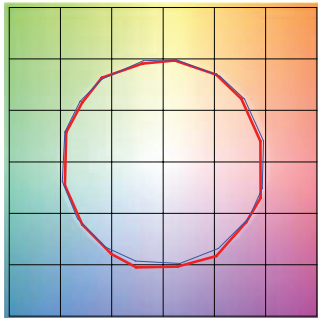

■ Test ■ Reference

HUE BIN	Rf	GRAPHIC SHIFTS %	
		CHROMA	HUE
1	92.5	-3.1%	0.3%
2	93.3	-2.3%	1.9%
3	90.9	-0.8%	3.9%
4	94.3	-1.1%	1.4%
5	92.5	-2.6%	1.5%
6	96.4	1.2%	-0.3%
7	92.6	-2.5%	-0.0%
8	96.9	-1.4%	0.2%
9	92.3	-1.8%	4.3%
10	86.6	-0.7%	7.0%
11	86.5	2.4%	8.2%
12	89.8	5.9%	1.7%
13	93.9	2.6%	-2.7%
14	89.4	5.1%	-5.8%
15	90.1	-0.1%	-4.7%
16	86.5	0.3%	-9.7%

**3500K** | Rf: 86.1 | Rg: 95.5

Color Vector Graphic

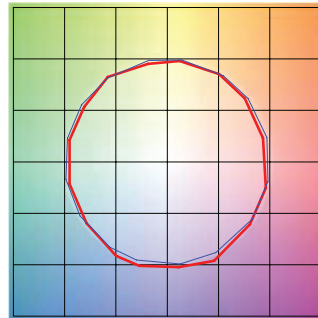

■ Test ■ Reference

HUE BIN	Rf	GRAPHIC SHIFTS %	
		CHROMA	HUE
1	90.8	-3.8%	0.3%
2	92.3	-2.8%	2.1%
3	89.7	-1.0%	4.3%
4	92.6	-1.4%	1.7%
5	91.8	-3.1%	1.3%
6	96.2	0.8%	-0.4%
7	92.9	-3.2%	0.2%
8	94.3	-2.5%	1.5%
9	90.4	-2.5%	5.2%
10	84.3	-1.4%	9.5%
11	83.1	3.5%	9.8%
12	88.2	4.8%	3.4%
13	94.0	2.7%	-2.0%
14	88.7	5.9%	-5.8%
15	88.7	0.7%	-5.9%
16	86.8	-0.7%	-6.7%

**3000D** | Rf: 89.8 | Rg: 101.4

Color Vector Graphic

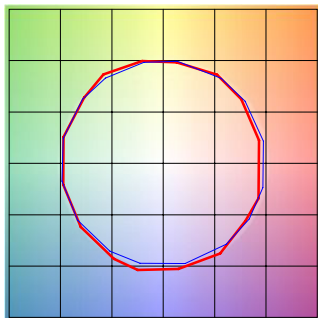

■ Test ■ Reference

HUE BIN	Rf	GRAPHIC SHIFTS %	
		CHROMA	HUE
1	90.2	-4.2%	1.5%
2	90.9	-2.0%	3.7%
3	87.9	0.8%	5.5%
4	92.1	-0.9%	0.6%
5	93.0	1.5%	1.6%
6	92.2	3.9%	-0.2%
7	92.1	-0.3%	-2.0%
8	96.7	0.0%	-1.2%
9	92.5	-0.6%	3.7%
10	88.3	1.1%	7.0%
11	87.2	4.1%	7.4%
12	87.2	6.7%	-1.0%
13	88.2	3.8%	-7.2%
14	85.3	4.3%	-9.9%
15	90.9	-2.2%	-3.6%
16	83.4	-2.2%	-11.2%

PROJECT	FIXTURE TYPE	DATE
---------	--------------	------