

TIE STIX SUSPENSION

POWER, CENTER FEED DIRECT DOWN LIGHT

DESIGNED BY GREGORY KAY | ASSEMBLED IN AMERICA

REV 08.20.21



DESCRIPTION

Tie Stix Center Feed is a linear LED suspension that creates a clean, direct beam of light using a Diffused White lens with a 100° beam spread. Offered in several sizes up to 96" and eleven versatile finishes, six metal and five wood options with corresponding metal hardware. The Tie Stix Center Feed Suspension is offered in 5 or 7-watt versions with Designer Grade Color Rendering LEDs (CRI 95+). Choose from nine standard Color Temperatures ranging between 2200K to 5700K, including two Warm Dim options of **(27D)** 2700K or **(30D)** 3000K that dim down to 2000K. Optional Fast Jack 12V Port Canopy **(C1)** for mounting Fast Jack fixtures to easily accommodate a variety of moods and tasks. Includes a 5-year pro-rated warranty. For custom lengths and quotes, email our design team design@PureEdgeLighting.com.

LAMPING

- Choose from 9 different color temperatures from 22K - 57K including Warm Dim
- Warm Dim - 2700K to 2000K **(27D)** or 3000K to 2000K **(30D)**
- 50,000 Hour Lamp Life
- Designer Grade High CRI 95+ LEDs

APPLICATIONS

Designed for indoor use only. Ideal applications include Residential, Commercial, Retail, and Hospitality environments.

ELECTRICAL

Power Supply: 120V/24V Electronic Low Voltage
 Power Consumption: 5 watts per foot, up to 420lm/ft
 7.5 watts per foot, up to 660lm/ft
 Dimming: Dimmable with ELV (Electronic Low Voltage)
 Approvals: Damp Location Suitable, ETL listed, Class 2 wiring.
 Assembled in America.

PHYSICAL ATTRIBUTES

Mounting Options: C (center feed) or C1 (Center Feed with 12V Fast Jack connection).
 Ordering Increments: Order in sizes ranging from 39" to 96". Max length for Chrome Channel is 84"
 Material: Genuine Hardwood, Cast Aluminum, Includes 12' of adjustable coaxial cables.
 Average LED Life: 50,000 hours @ normal use
 Warranty: PureEdge's 5 year pro-rated warranty, backed by over 30 years of precision manufacturing and design.

FINISHES*



*Wood finishes are authentic natural products, exact color and grain may vary. If you are trying to match an existing material, please contact us for a finish sample. We are able to accommodate some requests to pair our wood finishes with COM.

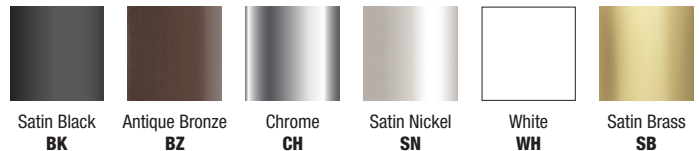

System	Wattage Per Foot	Power Feed	Nominal Size (L)	Color Temperature	Canopy & Hardware Finish	Channel Finish
TXSP	5W	C	40	27K	S	SN
TXSP Tie Stix Suspension With UNI Power in Canopy	5W 4.8 Watts 7W 7.5 Watts	C Center Feed C1 Center Feed with Fast Jack Port	39 40.5" 72 73.5" 48 49.5" 84 85.5"* 60 61.5" 96 97.5" *Due to natural nature of wood, metal finish lengths are reduced 2/5" from the nominal size. *84" Max Chrome length	22K 2200K Amber White 24K 2400K Very Warm White 27K 2700K Incandescent White 27D 2700K Warm Dim (5 Watt Only) 30K 3000K Warm White 30D 3000K Warm Dim (5 Watt Only) 35K 3500K Neutral White 40K 4000K Cool White 57K 5700K Daylight White	B Satin Black Z Antique Bronze C Chrome S Satin Nickel W White	WM Wood Maple WN Wood Walnut WC Wood Cherry WO Wood White Oak WE Wood Espresso BK Satin Black BZ Antique Bronze CH Chrome SN Satin Nickel WH White SB Satin Brass

PROJECT	FIXTURE TYPE	DATE
---------	--------------	------

LAMP DATA Lamp Data for Tie Stix Suspension

WATTS PER FOOT	TXSUP															
	5W (5 watts)								7W (7.5 watts)							
	22K	24K	27K	27D*	30K	30D*	35K	40K	57K	22K	24K	27K	30K	35K	40K	57K
COLOR TEMPERATURE	240	268	293	236	320	259	366	398	424	377	421	461	503	576	627	667
LUMENS PER FOOT (lm/ft)	55	61	67	49	73	54	83	91	96	52	58	63	69	79	86	91
LUMENS PER WATT (lm/w)	85+	90+	95+	95+	95+	95+	90+	85+	85+	85+	90+	95+	95+	90+	85+	85+
CRI	85+	90+	95+	95+	95+	95+	90+	85+	85+	85+	90+	95+	95+	90+	85+	85+

*27D, 30D - Warm Dim (4.8 Watts)

LENGTH CHART Actual Lengths for Wood & Metal finishes

ORDERING CODE (Nominal Size)	ACTUAL SIZE	
	WOOD CHANNEL OVERALL LENGTH (Inches)	METAL CHANNEL OVERALL LENGTH (Inches)
39	40.5"	40.1"
48	49.5"	49.1"
60	61.5"	61.1"
72	73.5"	73.1"
84*	85.5"	85.1"
96	97.5"	97.1"

*Maximum length for Chrome finish

WOOD FINISH OPTION EXAMPLES



SATIN NICKEL WITH CHERRY WOOD



CHROME WITH ESPRESSO WOOD



SATIN BLACK WITH MAPLE WOOD



CHROME WITH WALNUT WOOD



CHROME WITH WHITE OAK WOOD

METAL FINISH OPTION EXAMPLES



SATIN NICKEL WITH ANTIQUE BRONZE CHANNEL



SATIN BLACK WITH CHROME CHANNEL



WHITE WITH SATIN BLACK CHANNEL



CHROME WITH CHROME CHANNEL



BLACK WITH SATIN BRASS CHANNEL

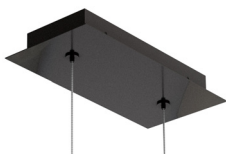

ANTIQUe BRONZE CANOPY



CHROME CANOPY



SATIN BLACK CANOPY



SATIN NICKEL CANOPY
(C1 CANOPY SHOWN WITH FJ PISTON
IN SATIN NICKEL, SOLD SEPARATELY)



WHITE CANOPY

PROJECT		FIXTURE TYPE		DATE	
---------	--	--------------	--	------	--

Drawings: Dimension drawings for the Tie Stix LED Suspension, Center Feed

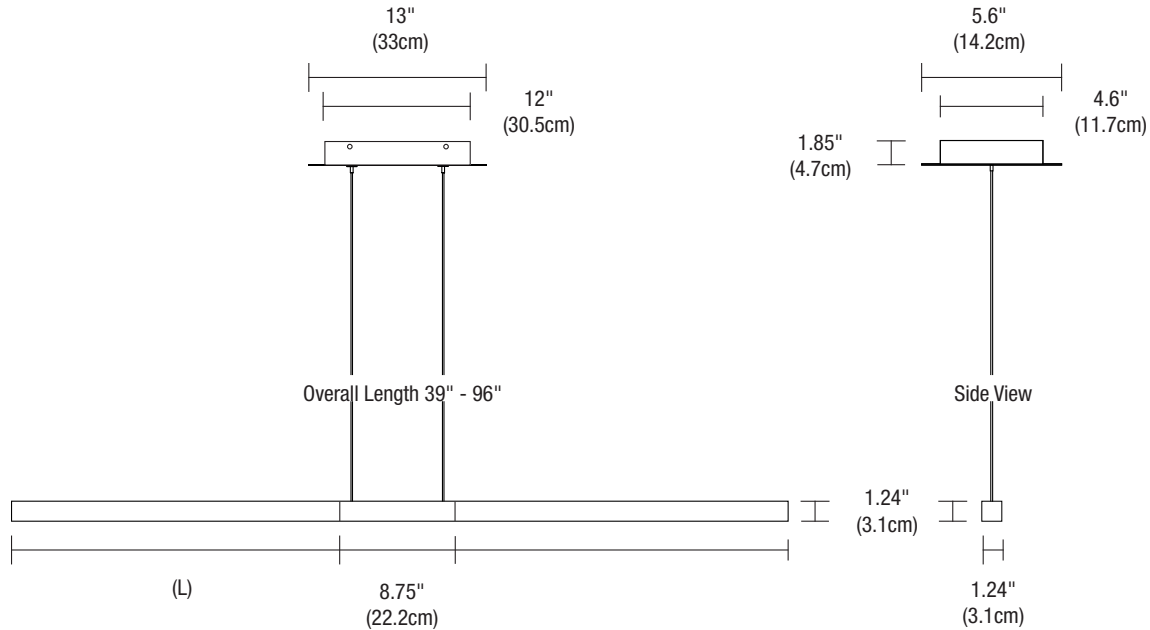

WIRING DIAGRAM

APPLICATION Dual ELV dimming for Tie Stix Suspension Center Feed Canopy with Fast Jack Port (C1)
DIMMING Dimmable with ELV dimmer: Legrand, Adorne ADTP703TU; Lutron: Diva DVELV-300P, Skylark SELV-300P, Maestro MAELV-600 and Radio Ra 2

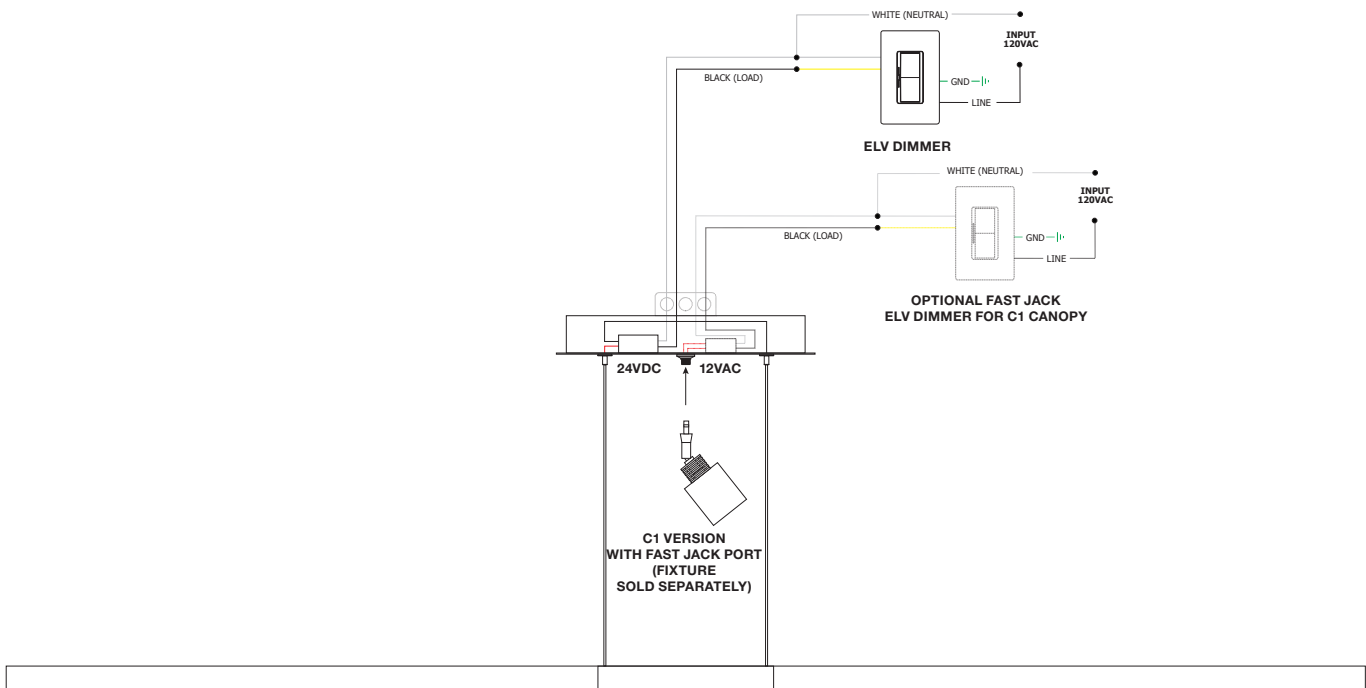

PROJECT	FIXTURE TYPE	DATE
---------	--------------	------

TM30 DATA

POWER, CENTER FEED DIRECT DOWN LIGHT

TM-30-15 DATA: The data below is for SS2C, SS5C, SS7C, and SS10C bare LED Soft Strips. Consistent color temperatures throughout a single strip and among multiple strips is possible through a 3 phase binning process in which each order is inspected with a color meter to ensure uniformity.

2200K | Rf: 83.9 | Rg: 94.9

Color Vector Graphic

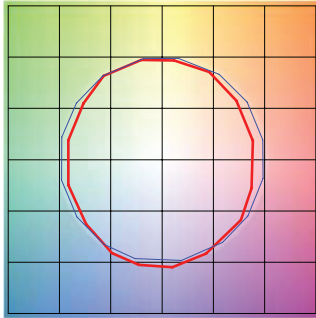

■ Test ■ Reference

HUE BIN	Rf	GRAPHIC SHIFTS %	
		CHROMA	HUE
1	78.8	-9.5%	1.3%
2	80.7	-7.8%	6.7%
3	78.2	-3.3%	9.4%
4	89.7	-2.8%	3.6%
5	93.2	-0.8%	2.6%
6	93.0	-0.6%	-0.7%
7	87.7	-5.9%	-3.5%
8	89.2	-6.8%	1.9%
9	83.4	-5.6%	6.0%
10	79.3	-3.7%	10.8%
11	81.4	2.9%	11.1%
12	84.9	5.3%	4.9%
13	88.1	4.9%	-10.1%
14	68.1	0.1%	-19.5%
15	86.0	-3.3%	-7.3%
16	76.4	-8.9%	-11.7%

2400K | Rf: 91.2 | Rg: 96.8

Color Vector Graphic

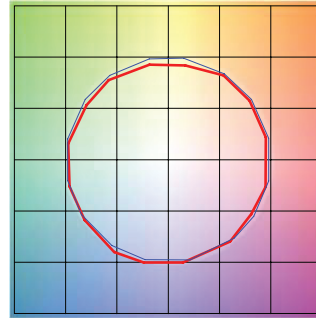

■ Test ■ Reference

HUE BIN	Rf	GRAPHIC SHIFTS %	
		CHROMA	HUE
1	92.0	-2.4%	1.5%
2	94.7	-2.1%	0.0%
3	95.4	-1.9%	-0.1%
4	88.7	-6.7%	-3.1%
5	92.8	-5.6%	1.0%
6	92.7	-3.4%	3.4%
7	89.9	-4.3%	4.1%
8	92.4	-1.4%	4.4%
9	89.0	-0.6%	5.8%
10	88.9	0.4%	6.2%
11	89.7	4.0%	5.4%
12	92.6	3.0%	-0.7%
13	90.9	1.1%	-7.0%
14	89.9	0.5%	-5.8%
15	92.1	-3.2%	0.1%
16	88.9	-1.7%	-6.3%

2700K | Rf: 87.7 | Rg: 96.1

Color Vector Graphic

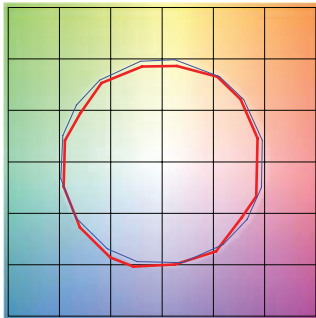

■ Test ■ Reference

HUE BIN	Rf	GRAPHIC SHIFTS %	
		CHROMA	HUE
1	88.0	-4.3%	2.6%
2	91.6	-2.4%	2.0%
3	93.7	-1.4%	1.9%
4	88.9	-5.6%	-3.1%
5	92.3	-5.5%	-0.5%
6	92.9	-3.5%	0.1%
7	84.5	-7.5%	4.6%
8	90.8	-3.0%	4.4%
9	84.5	-1.3%	8.3%
10	83.9	2.0%	9.8%
11	87.2	5.3%	7.1%
12	89.2	5.4%	-2.6%
13	88.7	0.3%	-7.8%
14	86.8	1.7%	-9.3%
15	87.6	-5.4%	-1.3%
16	83.6	-3.3%	-9.5%

3000K | Rf: 88.1 | Rg: 99.7

Color Vector Graphic

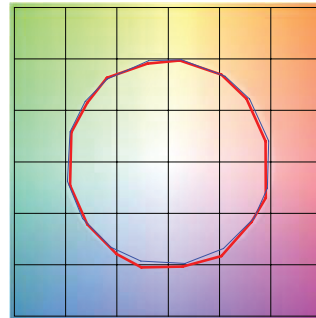

■ Test ■ Reference

HUE BIN	Rf	GRAPHIC SHIFTS %	
		CHROMA	HUE
1	92.5	-3.1%	0.3%
2	93.3	-2.3%	1.9%
3	90.9	-0.8%	3.9%
4	94.3	-1.1%	1.4%
5	92.5	-2.6%	1.5%
6	96.4	1.2%	-0.3%
7	92.6	-2.5%	-0.0%
8	96.9	-1.4%	0.2%
9	92.3	-1.8%	4.3%
10	86.6	-0.7%	7.0%
11	86.5	2.4%	8.2%
12	89.8	5.9%	1.7%
13	93.9	2.6%	-2.7%
14	89.4	5.1%	-5.8%
15	90.1	-0.1%	-4.7%
16	86.5	0.3%	-9.7%

3500K | Rf: 86.1 | Rg: 95.5

Color Vector Graphic

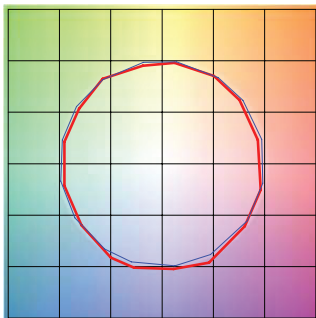

■ Test ■ Reference

HUE BIN	Rf	GRAPHIC SHIFTS %	
		CHROMA	HUE
1	90.8	-3.8%	0.3%
2	92.3	-2.8%	2.1%
3	89.7	-1.0%	4.3%
4	92.6	-1.4%	1.7%
5	91.8	-3.1%	1.3%
6	96.2	0.8%	-0.4%
7	92.9	-3.2%	0.2%
8	94.3	-2.5%	1.5%
9	90.4	-2.5%	5.2%
10	84.3	-1.4%	9.5%
11	83.1	3.5%	9.8%
12	88.2	4.8%	3.4%
13	94.0	2.7%	-2.0%
14	88.7	5.9%	-5.8%
15	88.7	0.7%	-5.9%
16	86.8	-0.7%	-6.7%

4000K | Rf: 87.6 | Rg: 96.8

Color Vector Graphic

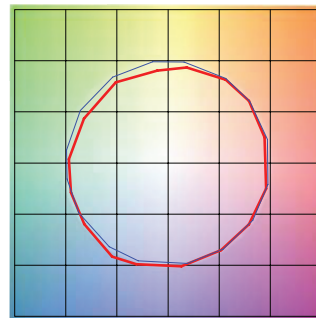

■ Test ■ Reference

HUE BIN	Rf	GRAPHIC SHIFTS %	
		CHROMA	HUE
1	88.9	-2.4%	2.5%
2	93.3	-0.4%	0.8%
3	94.8	-1.0%	-0.6%
4	87.9	-4.9%	-3.6%
5	85.3	-9.4%	-2.6%
6	90.2	-6.0%	0.2%
7	85.3	-7.6%	4.6%
8	83.7	-4.1%	8.2%
9	79.5	-1.1%	13.8%
10	78.6	1.5%	12.1%
11	83.5	6.4%	7.8%
12	90.9	3.6%	-1.1%
13	88.3	1.7%	-6.3%
14	91.9	-0.4%	-2.2%
15	84.5	-0.9%	-5.5%
16	84.7	-1.1%	-4.4%

PROJECT	FIXTURE TYPE	DATE
---------	--------------	------

TM30 DATA

POWER, CENTER FEED DIRECT DOWN LIGHT

TM-30-15 DATA: The data below is for SS5C and SS7C bare LED Soft Strips. Consistent color temperatures throughout a single strip and among multiple strips is possible through a 3 phase binning process in which each order is inspected with a color meter to ensure uniformity.

5700K | Rf: 80.3 | Rg: 91.5

Color Vector Graphic

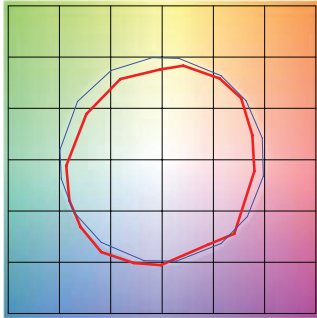

■ Test ■ Reference

GRAPHIC SHIFTS %			
HUE BIN	Rf	CHROMA	HUE
1	75.4	-8.9%	4.7%
2	87.5	-2.6%	4.6%
3	90.7	-3.0%	-0.5%
4	83.2	-6.0%	-5.7%
5	76.2	-12.9%	-5.3%
6	81.4	-11.9%	-2.6%
7	74.8	-14.0%	5.1%
8	69.0	-9.0%	14.1%
9	72.6	-3.6%	22.2%
10	71.4	2.7%	16.1%
11	81.3	7.9%	5.3%
12	83.6	4.1%	-9.4%
13	78.4	0.7%	-15.3%
14	77.7	-6.2%	-11.0%
15	68.8	-1.3%	-21.2%
16	80.8	-9.6%	3.3%

2700D | Rf: 89.5 | Rg: 100.8

Color Vector Graphic

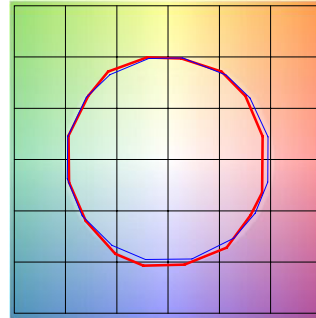

■ Test ■ Reference

GRAPHIC SHIFTS %			
HUE BIN	Rf	CHROMA	HUE
1	88.8	-5.1%	1.4%
2	89.8	-2.7%	4.1%
3	87.2	0.3%	5.9%
4	92.3	-0.9%	1.0%
5	93.3	1.5%	1.7%
6	92.4	3.6%	-0.2%
7	92.2	-0.9%	-2.4%
8	96.7	-0.4%	-1.1%
9	92.3	-1.2%	3.7%
10	88.9	-0.0%	6.1%
11	86.4	5.1%	7.4%
12	88.2	6.3%	-0.9%
13	87.2	3.8%	-8.1%
14	84.2	3.8%	-11.0%
15	89.8	-2.6%	-4.3%
16	82.7	-3.4%	-11.1%

3000D | Rf: 89.8 | Rg: 101.4

Color Vector Graphic

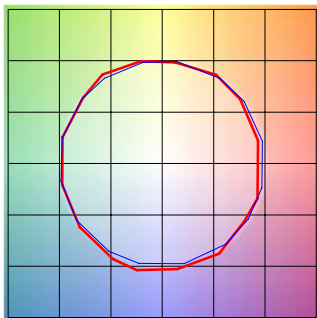

■ Test ■ Reference

GRAPHIC SHIFTS %			
HUE BIN	Rf	CHROMA	HUE
1	90.2	-4.2%	1.5%
2	90.9	-2.0%	3.7%
3	87.9	0.8%	5.5%
4	92.1	-0.9%	0.6%
5	93.0	1.5%	1.6%
6	92.2	3.9%	-0.2%
7	92.1	-0.3%	-2.0%
8	96.7	0.0%	-1.2%
9	92.5	-0.6%	3.7%
10	88.3	1.1%	7.0%
11	87.2	4.1%	7.4%
12	87.2	6.7%	-1.0%
13	88.2	3.8%	-7.2%
14	85.3	4.3%	-9.9%
15	90.9	-2.2%	-3.6%
16	83.4	-2.2%	-11.2%

PROJECT	FIXTURE TYPE	DATE
---------	--------------	------

TIE STIX SUSPENSION

POWER, CENTER FEED DIRECT DOWN LIGHT



FJ-SCO-1-PN
Fast Jack Scope LED
9W, 315 lumens 3000K
(adjustable beam spread
from 20°-50°)
Fixture Finishes: SN, PN, BZ, WH



FJ-PST-SP-1-30K-SN
Fast Jack Piston
9W, 650 lumens
SP 15°, NF 25°, FL 35°
& WF 45° Beam Spreads
Fixture Finishes: SN, WH



FJ-FOR-SQ-3-PN
FJ-FOR-RD-3-PN
Fast Jack Form Round or Square
Fixture Finishes: SN, PN



FJ-FOR-2RD-3-SN
FJ-FOR-2SQ-3-SN
Fast Jack Form
Round or Square 2-Head
Fixture Finishes: SN, PN



FJ-REB-1-PN
Fast Jack Rebel
Fixture Finishes: SN, PN, BZ, WH

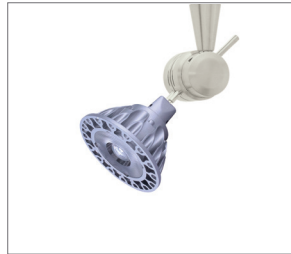

FJ-CHO-1-SN
Fast Jack Chopper with LED
Fixture Finishes: SN, PN, BZ



FJ-SPI-3-PN with S1-PN
Fast Jack Spirit, S1 Shade
Fixture Finishes: SN, PN, BZ
S1 Shade Finishes: SN, PN, BZ, BK



FJ-LOW-1-SN with S1-SN
Fast Jack Low Rider, S1 Shade
Fixture Finishes: SN, PN, BZ
S1 Shade Finishes: SN, PN, BZ, BK

FAST JACK FIXTURE & SHADE FINISHES

SN	Satin Nickel	PN	Polished Nickel	BZ	Antique Bronze	WH	White	BK	Black
-----------	--------------	-----------	-----------------	-----------	----------------	-----------	-------	-----------	-------

PROJECT		FIXTURE TYPE		DATE	
---------	--	--------------	--	------	--

12VAC LED MR16

REV 08.20.21

SOL LIGHT WARM DIM

Brand	Ordering Code	Watts	CRI	R9	Beam Angle (Degrees)	Lamp Life (Hours)	CCT Warm Dim	Total Lumens	Lumens Per Watt	Voltage	Certification	Halogen Equivalent
	MR16-12V-8W-FL-27KWDH-SL	8	97+	85	36	30,000	2700K dims to 1800K	390	50	12V	Low flicker <1% CE, UL, NOM	50
	MR16-12V-8W-FL-30KWDH-SL	8	97+	85	36	30,000	3000K dims to 1800K	427	55	12V	Low flicker <1% CE, UL, NOM	50
	MR16-12V-8W-NF-27KWDH-SL	8	97+	85	24	30,000	2700K dims to 1800K	410	53	12V	Low flicker <1% CE, UL, NOM	50
	MR16-12V-8W-NF-30KWDH-SL	8	97+	85	24	30,000	3000K dims to 1800K	450	58	12V	Low flicker <1% CE, UL, NOM	50

SORAA BRILLIANT HIGH LUMEN 2700K COLOR TEMPERATURE

Brand	Ordering Code	Watts	CRI	R9	Beam Angle (Degrees)	Lamp Life (Hours)	CBCP	Total Lumens	Lumens Per Watt	Voltage	Certification	Halogen Equivalent
	SM16-07-10D-827-H1*	8	90	80	10	35,000	8,000	575	77	12V +/- 1.2V	Title 20 certification pending, UL/CUL Class 2 and non-Class 2, FCC Title 47 Part 15B, RoHS, CE	75
	SM16-07-25D-827-H1	8	90	80	25	35,000	3,710	600	80	12V +/- 1.2V	Title 20 certification pending, UL/CUL Class 2 and non-Class 2, FCC Title 47 Part 15B, RoHS, CE	75
	SM16-07-36D-827-H1	8	90	80	36	35,000	1,550	600	80	12V +/- 1.2V	Title 20 certification pending, UL/CUL Class 2 and non-Class 2, FCC Title 47 Part 15B, RoHS, CE	75

*Use with Snap Lens

SORAA VIVID 2700K COLOR TEMPERATURE INDOOR/OUTDOOR

Brand	Ordering Code	Watts	CRI	R9	Beam Angle (Degrees)	Lamp Life (Hours)	CCT Warm Dim	Total Lumens	Lumens Per Watt	Voltage	Certification	Halogen Equivalent
	SM16-07-10d-927-03*	8	95	95	10	35,000	5,710	390	52	12V +/- 1.2V	UL/CUL Class 2 and non-Class 2, FCC Title 47 Part 15B, RoHS, CE	50
	SM16-07-25D-927-03	8	95	95	25	35,000	2,260	410	55	12V +/- 1.2V	UL/CUL Class 2 and non-Class 2, FCC Title 47 Part 15B, RoHS, CE	50
	SM16-07-36D-927-03	8	95	95	36	35,000	1,070	410	55	12V +/- 1.2V	UL/CUL Class 2 and non-Class 2, FCC Title 47 Part 15B, RoHS, CE	50

*Use with Snap Lens

SORAA HEALTHY

Brand	Ordering Code	Watts	CRI	R9	Beam Angle (Degrees)	Lamp Life (Hours)	CCT Warm Dim	Total Lumens	Lumens Per Watt	Voltage	Certification	Halogen Equivalent
	SH-MR16-07-36D-27-01-X2	8	80	90	36	25,000	1,020	400	53	12V +/- 1.2V	UL/CUL, FCC Title 47 Part 15B, RoHS	50

SORAA BRILLIANT HIGH LUMEN 3000K COLOR TEMPERATURE

Brand	Ordering Code	Watts	CRI	R9	Beam Angle (Degrees)	Lamp Life (Hours)	CBCP	Total Lumens	Lumens Per Watt	Voltage	Certification	Halogen Equivalent
	SM16-07-10D-830-H1*	8	90	80	10	35,000	8,400	600	80	12V +/- 1.2V	Title 20 certification pending, UL/CUL Class 2 and non-Class 2, FCC Title 47 Part 15B, RoHS, CE	75
	SM16-07-25D-830-H1	8	90	80	25	35,000	3,300	630	84	12V +/- 1.2V	Title 20 certification pending, UL/CUL Class 2 and non-Class 2, FCC Title 47 Part 15B, RoHS, CE	75
	SM16-07-36D-830-H1	8	90	80	36	35,000	1,650	630	84	12V +/- 1.2V	Title 20 certification pending, UL/CUL Class 2 and non-Class 2, FCC Title 47 Part 15B, RoHS, CE	75

*Use with Snap Lens

PROJECT		FIXTURE TYPE		DATE	
---------	--	--------------	--	------	--

12VAC LED MR16

REV 08.20.21

SORAA VIVID 3000K COLOR TEMPERATURE MR16 INDOOR/OUTDOOR

Brand	Ordering Code	Watts	CRI	R9	Beam Angle (Degrees)	Lamp Life (Hours)	CCT Warm Dim	Total Lumens	Lumens Per Watt	Voltage	Certification	Halogen Equivalent
	SM16-07-10D-930-03*	8	95	95	10	35,000	6,000	410	55	12V +/- 1.2V	UL/CUL Class 2 and non-Class 2, FCC Title 47 Part 15B, RoHS, CE	50
	SM16-07-25D-930-03	8	95	95	25	35,000	2,400	435	58	12V +/- 1.2V	UL/CUL Class 2 and non-Class 2, FCC Title 47 Part 15B, RoHS, CE	50
	SM16-07-36D-930-03	8	95	95	36	35,000	1,130	435	58	12V +/- 1.2V	UL/CUL Class 2 and non-Class 2, FCC Title 47 Part 15B, RoHS, CE	50

*Use with Snap Lens

SORAA VIVID 4000K COLOR TEMPERATURE MR16 INDOOR/OUTDOOR

Brand	Ordering Code	Watts	CRI	R9	Beam Angle (Degrees)	Lamp Life (Hours)	CBCP	Total Lumens	Lumens Per Watt	Voltage	Certification	Halogen Equivalent
	SM16-07-10D-940-03*	8	95	95	10	35,000	6,290	430	57	12V +/- 1.2V	UL/CUL Class 2 and non-Class 2, FCC Title 47 Part 15B, RoHS, CE	50
	SM16-07-25D-940-03	8	95	95	25	35,000	2,510	455	61	12V +/- 1.2V	UL/CUL Class 2 and non-Class 2, FCC Title 47 Part 15B, RoHS, CE	50
	SM16-07-36D-940-03	8	95	95	36	35,000	1,190	455	61	12V +/- 1.2V	UL/CUL Class 2 and non-Class 2, FCC Title 47 Part 15B, RoHS, CE	50

*Use with Snap Lens

SATCO 3500K COLOR TEMPERATURE MR16 INDOOR/OUTDOOR

Brand	Ordering Code	Watts	CRI	R9	Beam Angle (Degrees)	Lamp Life (Hours)	CBCP	Total Lumens	Lumens Per Watt	Voltage	Certification	Halogen Equivalent
	S8637	8	90+	N/A	15	25,000	6,290	430	61	12	UL/CUL, FCC Title 47 Part 15B, RoHS, Lawful for sale in California	75
	S8642	8	90+	N/A	40	25,000	2,510	455	61	12	UL/CUL, FCC Title 47 Part 15B, RoHS, Lawful for sale in California	75

8MR16/LED/40/35K/90CRI/12V 8 watt; LED MR16; 3500K; 40° beam spread; GU5.3 base; 12 volts. Features: Silver back MR16 reflector. Direct replacements for 75 watt Halogen lamps - uses only 8 watts. Dimmable. No UV or IR radiation. Approved for enclosed fixtures.

PROJECT		FIXTURE TYPE		DATE	
---------	--	--------------	--	------	--

SORAA VIVID MR16 36° FL
3000K | Rf: 90.4 | Rg: 99.5
 Color Vector Graphic

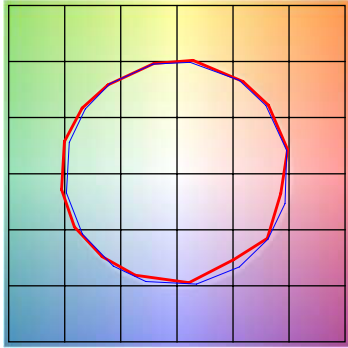

■ Test ■ Reference

HUE BIN	Rf	GRAPHIC SHIFTS %	
		CHROMA	HUE
1	94.4	1.0%	0.8%
2	94.6	2.1%	-1.1%
3	91.9	1.1%	-3.3%
4	91.9	2.1%	-2.1%
5	93.9	0.4%	-0.9%
6	95.2	0%	1.9%
7	93.4	2.7%	-0.7%
8	92.7	4.2%	0.1%
9	90.5	3.6%	-3.9%
10	84.3	2.3%	-9.2%
11	81.3	2.3%	-12.7%
12	81.3	-3.6%	-10.3%
13	90.5	-2.5%	-6.2%
14	88.5	-8.2%	-0.4%
15	96.2	-1.0%	0.3%
16	86.6	-5.4%	8.2%

SOL-LIGHT WARM DIM MR16 36° FL
3000K | Rf: 94.2 | Rg: 101.2
 Color Vector Graphic

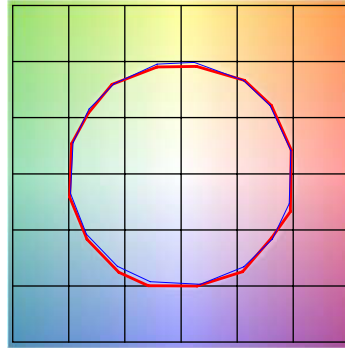

■ Test ■ Reference

HUE BIN	Rf	GRAPHIC SHIFTS %	
		CHROMA	HUE
1	96.0	0.3%	0.7%
2	96.8	0.9%	-0.8%
3	95.6	0.5%	-0.8%
4	93.1	-3.2%	-2.7%
5	95.7	-2.4%	0.4%
6	96.8	0.4%	1.6%
7	92.4	-1.4%	3.5%
8	96.8	1.2%	1.2%
9	94.0	1.4%	3.1%
10	92.6	2.1%	3.9%
11	92.2	3.7%	3.9%
12	92.4	3.9%	-0.9%
13	94.7	0.9%	-3.3%
14	93.4	3.0%	-3.2%
15	93.6	-1.1%	0.9%
16	90.2	2.4%	-6.7%

SORAA VIVID MR16 25° NFL
3000K | Rf: 94.0 | Rg: 101.0
 Color Vector Graphic

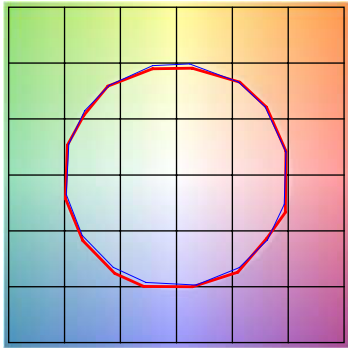

■ Test ■ Reference

HUE BIN	Rf	GRAPHIC SHIFTS %	
		CHROMA	HUE
1	95.9	0.3%	0.8%
2	96.8	0.8%	-0.9%
3	95.5	0.4%	-0.9%
4	92.7	-3.4%	-2.9%
5	95.6	-2.7%	0.4%
6	96.8	0.1%	1.6%
7	92.2	-1.6%	3.7%
8	96.6	1.1%	1.5%
9	93.7	1.4%	3.3%
10	92.4	2.2%	4.1%
11	92.2	3.8%	3.8%
12	92.4	3.9%	-1.1%
13	94.4	0.8%	-3.6%
14	93.3	2.8%	-3.4%
15	93.4	-1.4%	0.9%
16	90.3	2.2%	-6.7%

SOL-LIGHT WARM DIM MR16 24° NFL
3000K | Rf: 94.2 | Rg: 101.2
 Color Vector Graphic

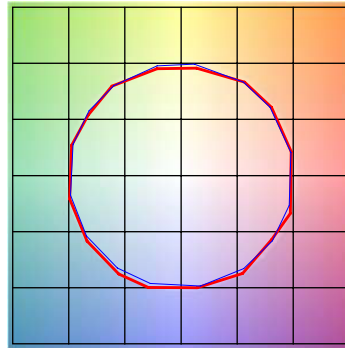

■ Test ■ Reference

HUE BIN	Rf	GRAPHIC SHIFTS %	
		CHROMA	HUE
1	95.9	0.3%	0.8%
2	96.8	0.8%	-0.9%
3	95.5	0.4%	-0.9%
4	92.7	-3.4%	-2.9%
5	95.6	-2.7%	0.4%
6	96.8	0.1%	1.6%
7	92.2	-1.6%	3.7%
8	96.6	1.1%	1.5%
9	93.7	1.4%	3.3%
10	92.4	2.2%	4.1%
11	92.2	3.8%	3.8%
12	92.4	3.9%	-1.1%
13	94.4	0.8%	-3.6%
14	93.3	2.8%	-3.4%
15	93.4	-1.4%	0.9%
16	90.3	2.2%	-6.7%

PROJECT	FIXTURE TYPE	DATE
---------	--------------	------