

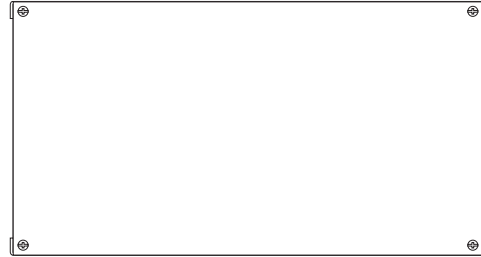

1718 W. Fullerton Chicago, IL 60614  
 Ph: 773.770.1195 • Fax: 773.935.5613  
 www.PureEdgeLighting.com • info@PureEdgeLighting.com  
 © 2016 PureEdge Lighting. All Rights Reserved.

## Installation Instructions for **100 Watt 24 Volt DC RGB DMX LED Power Supply**



**SAVE THESE INSTRUCTIONS!**



### GENERAL INFORMATION

- **RISK OF FIRE:** This product must be installed by a qualified electrician. Turn the power to the electrical box off during installation. Read the "Important Safety Instructions " before installation.
- **NOTE:** To avoid overheating the power supply, install it in a ventilated remote location where air flows. Maintain proper spacing among power supplies when multiple power supplies are installed in the same remote location.
- This product is not suitable for wet locations. It is approved for the use at any height above the finished floor.
- A typical installation is shown. Specific installation must be in accordance with the local electrical codes.
- **TO REDUCE RISK OF FIRE,** it is important to wire the power supply for the system as described in this installation instruction.
- Load the power supply to **MAXIMUM 100** Watts.
- Use CDP color dial, CTP color touch screen controller, or CDMX RGB/RGBW Touch Controller with RGB LED soft strip.

### IMPORTANT SAFETY INSTRUCTIONS

- Do not install this power supply in a wet location.
- To reduce the risk of the system overheating and possibly causing a fire, make sure all the connections are tight.
- Do not install \*LED fixture closer than three inches or as specified in the \*LED fixture installation instructions to curtains or similarly combustible materials. Keep insulation at least 3" away from the enclosure.
- Turn the electrical power off before modifying the lighting system in any way.
- The system is "ETL" listed for USA and Canada only when all the products used are supplied by Edge Lighting.
- \* See LED fixture installation instructions for proper placement.

**100W, 24VAC LOW VOLTAGE WIRE SIZE CHART**

3% VOLTAGE DROP	WIRE LENGTH IN FT	UP TO 31FT	32FT-49FT	50FT-81FT	82FT-124FT
	WIRE SIZE	14 AWG	12 AWG	10 AWG	8 AWG
	VOLTAGE AT END OF THE WIRE	23.28 VAC	23.29 VAC	23.28 VAC	23.28 VAC

# Section One: Using LED Power Supply with RGB Soft Strip & CDP, CTP, or CDMX RGB/RGBW Controller

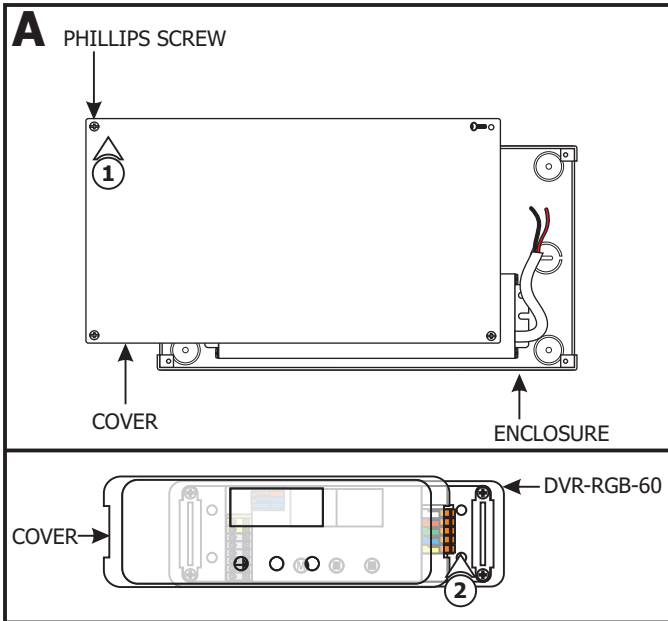

**NOTE: Refer to Section Two if using alternative driver with LED power supply.**

**1:** Loosen the four Phillips screws on front of the power supply to remove the cover.

**2:** Carefully pull off the cover from the DVR-RGB-60 driver.

**NOTE:** Use a deep double gang boxes to fit the controller and controller power supply.

**NOTE:** Refer to the "Configuring and Operating Dim Wheel" on pages 5 and 6 to properly operate the controller.

**3:** Connect one end of a red wire to the "VDC+" terminal of the controller and the other end to the "+24VDC" terminal of the controller power supply.

**4:** Connect one end of a black wire to the "Ground" terminal of the controller and the other end to the "-24VDC" terminal of the controller power supply.

**5:** Connect the white wire to "N" terminal of the controller power supply.

**6:** Connect the black wire to "L" terminal of the controller power supply.

**7:** Install conduits from the controller, main panel (line voltage), and soft strip to the power supply enclosure.

**8:** Run the black and white line voltage wires coming from the controller power supply to the power supply enclosure.

**9:** Run the proper size DMX cable (**Belden #9841 recommended**) with three data wires from controller to the power supply enclosure.

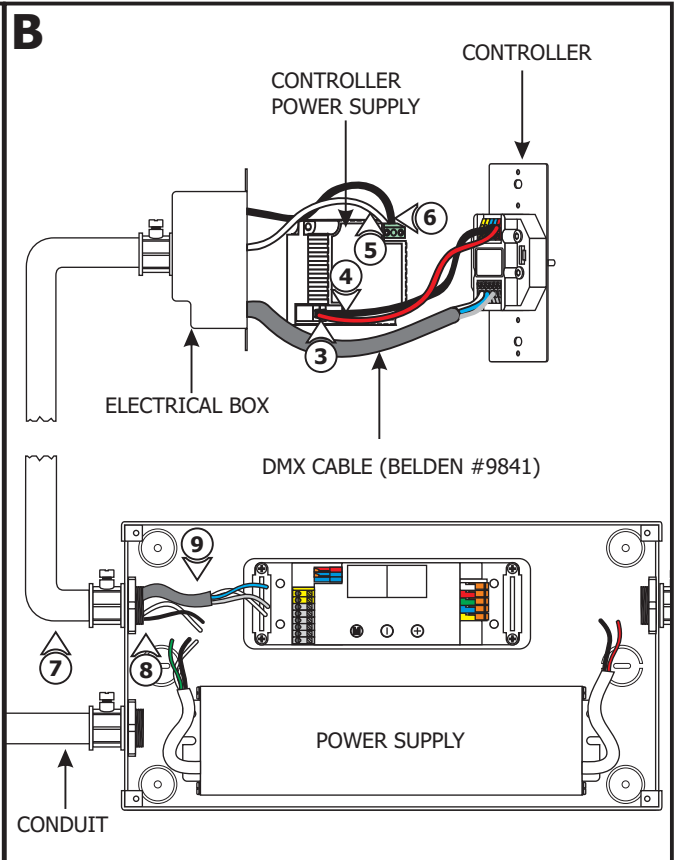

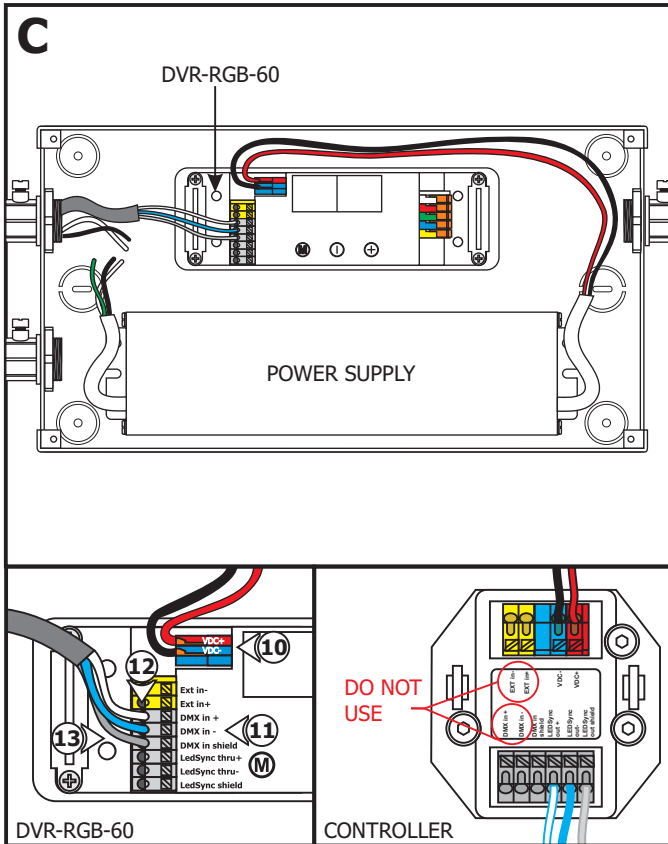

- 10:** Connect the red wire from the power supply to the "VDC+" DVR-RGB-60 red terminal. Connect the black wire from the power supply to the "VDC-" DVR-RGB-60 blue terminal.
- 11:** Connect one end of a data wire (blue with white stripes wire) to the "LEDSYNC OUT-" controller terminal. Connect the other end into the "DMX in -" DVR-RGB-60 terminal.
- 12:** Connect one end of a data wire (white with blue stripes wire) to the "LEDSYNC OUT+" controller terminal. Connect the other end into the "DMX in +" DVR-RGB-60 terminal.
- 13:** Connect one end of a data wire (bare shield wire) to the "LEDSYNC SHIELD" controller terminal. Connect the other end into the "DMX in shield" DVR-RGB-60 terminal.

**NOTE:** "DMX in+", "DMX in-", "EXT in+" & "EXT in-", controller terminals are not used on controller.

- 14:** Run the line voltage power wires to the power supply enclosure.
- 15:** Connect the hot power wire to the black power supply wire and black controller power supply wire using a wire nut.
- 16:** Connect the neutral power wire to the white power supply wire and white controller power supply wire using a wire nut.
- 17:** Make sure the green power supply wire is grounded in accordance with local electrical codes.

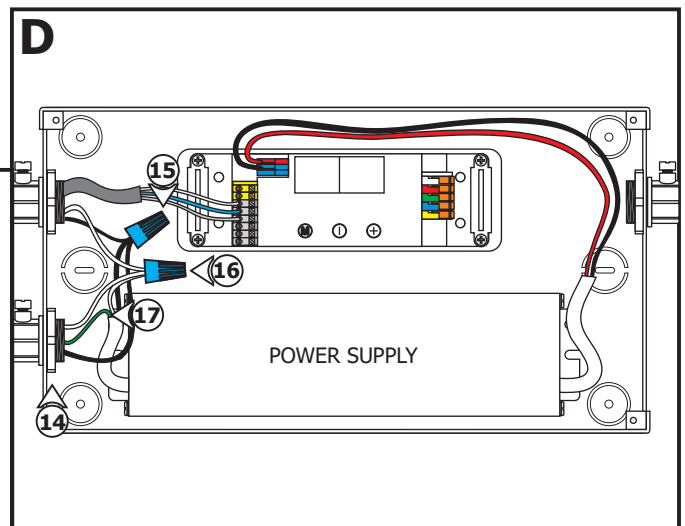

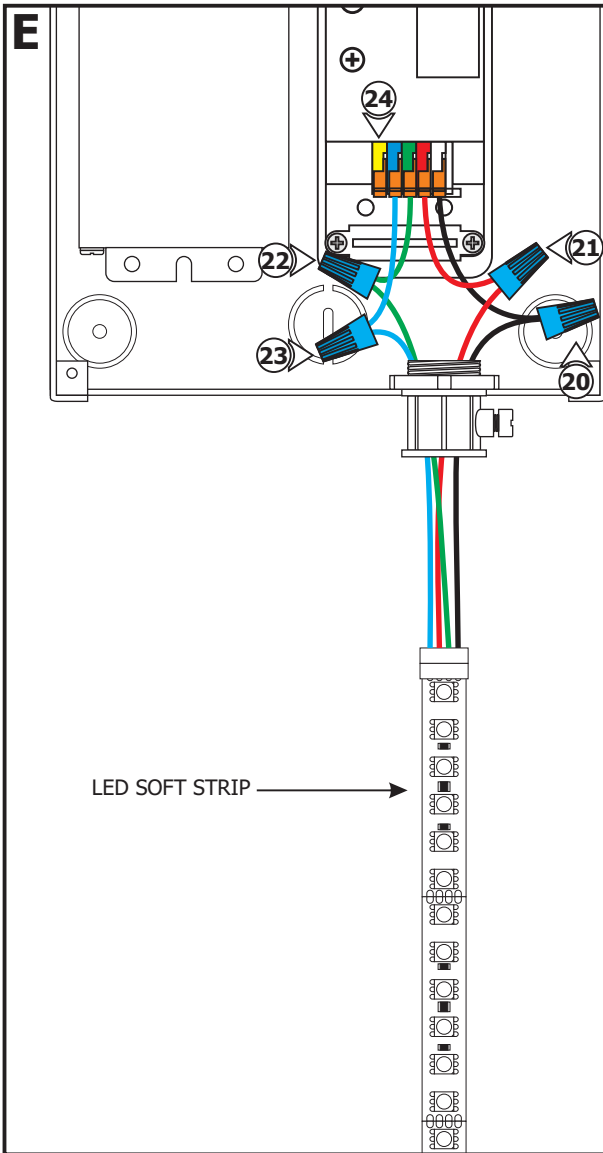

**NOTE:** The DVR-RGB-60 terminals adapt maximum 18 AWG size. To avoid voltage drop, use 6" of 18 AWG size in RGB terminals connected inline to proper size gauge wire attached to the RGB LED wires with wire nuts. See the "Low Voltage Wire Size Chart" on page 1.

**NOTE:** Do not exceed the maximum wattage of the power supply.

**NOTE:** Use only 24 volt LED RGB soft strip with this power supply.

**18:** Use the "Low Voltage Wire Size Chart" on page 1 to determine proper wire size connecting to the DVR-RGB-60 terminals.

**19:** Run the proper size black, red, green, blue, and white wires from the RGB LED soft strip to the power supply enclosure.

**20:** Connect the black wire into the DVR-RGB-60 "LED SUPPLY +" white terminal. Connect the other end to the black wire of the RGB soft strip.

**21:** Connect the red wire into the DVR-RGB-60 "Group 1-" red terminal. Connect the other end to the red wire of the RGB soft strip.

**22:** Connect the green wire into the DVR-RGB-60 "Group 2-" green terminal. Connect the other end to the green wire of the RGB soft strip.

**23:** Connect the blue wire into the DVR-RGB-60 "Group 3-" blue terminal. Connect the other end to the blue wire of the RGB soft strip.

**24: Optional:** For RGB+W, connect the white wire into the DVR-RGB-60 "Group 4-" yellow terminal. Connect the other end to the white wire of the RGB+W soft strip.

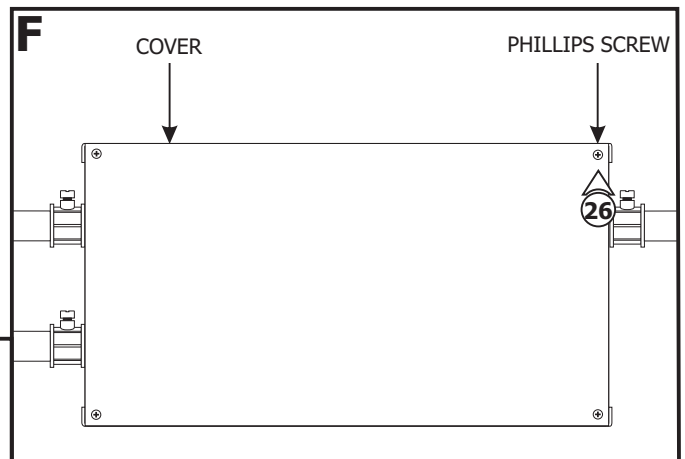

**25:** Replace the DVR-RGB-60 cover.

**26:** Replace the power supply cover and secure it by tightening the four Phillips screws.

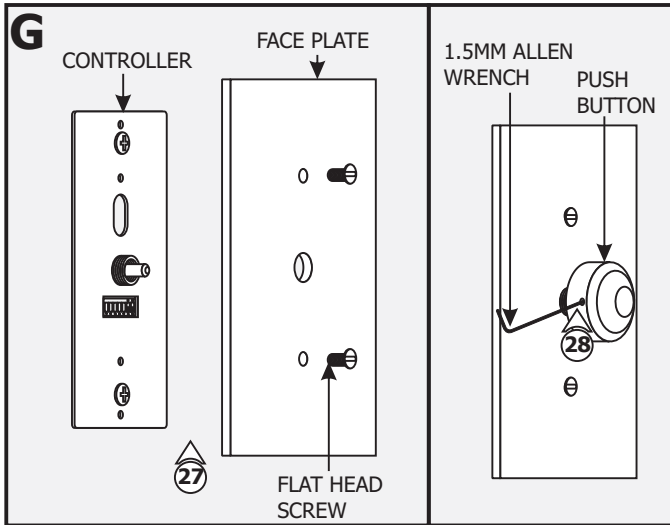

**27:** Align the face plate to the controller and secure using the two flat head screws.

**28:** Attach the push button onto the controller center rod and secure by tightening the M3 set screw with the 1.5mm Allen wrench provided.

## Configuring and Operating Dim Wheel

### Selecting Modes

Configure your CDP by setting the DIP switches on the front:



COLOR MODE



CHASE MODE

**NOTE:** The DIP switches must remain accessible after installation. When making changes in the DIP switch settings, disconnect and reconnect the power supply to activate new settings.

### Operating CDP

1- Turn the light on



2- Change brightness

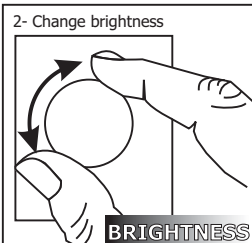

3- Turn the light off



### Advanced Operation for Color Mode

1- Turn the light on

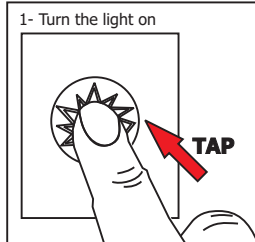

2- Activate configuration mode

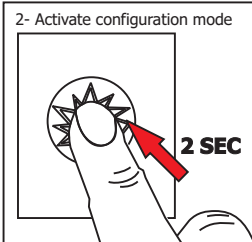

3- Set Color

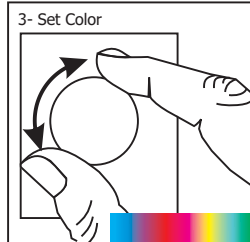

4- Save color saving



### Advanced Operation for Chase Mode

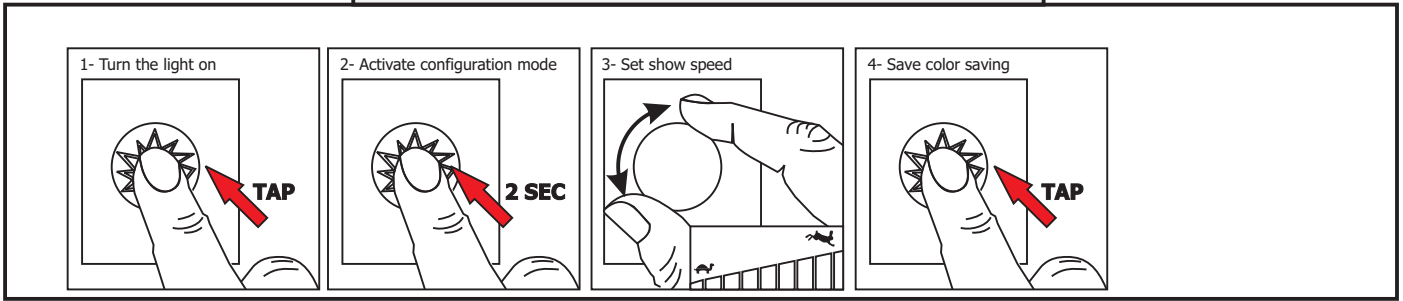

### Advanced Operation for RGBW

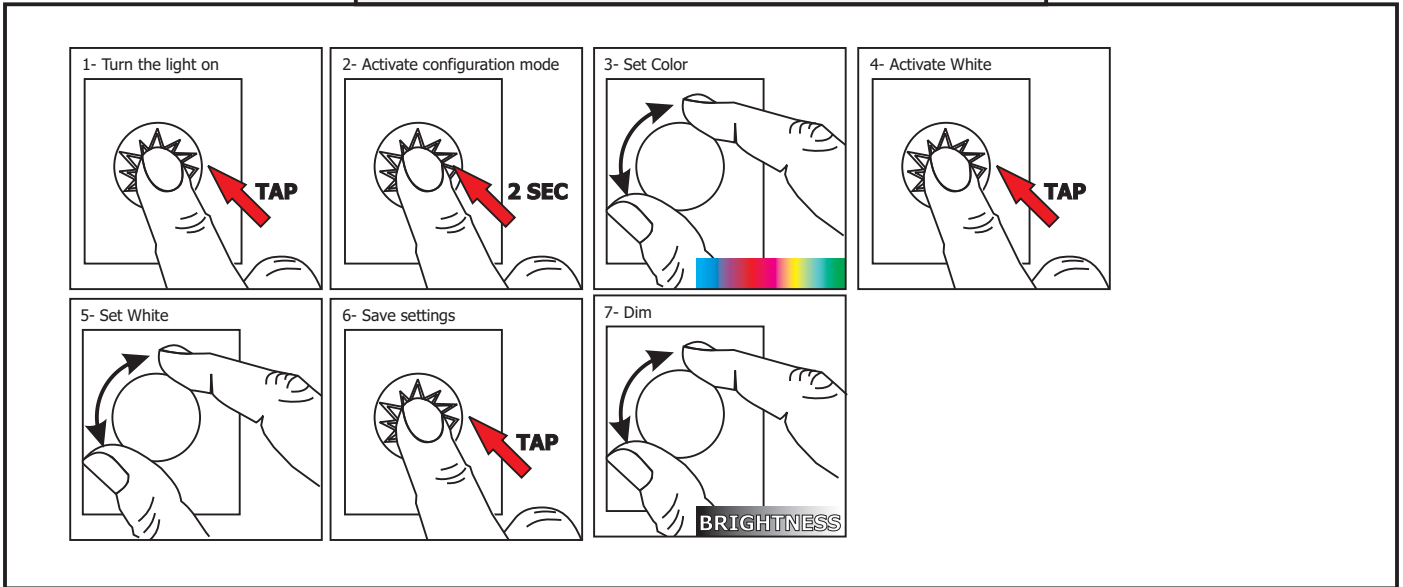

# RGB Configuration

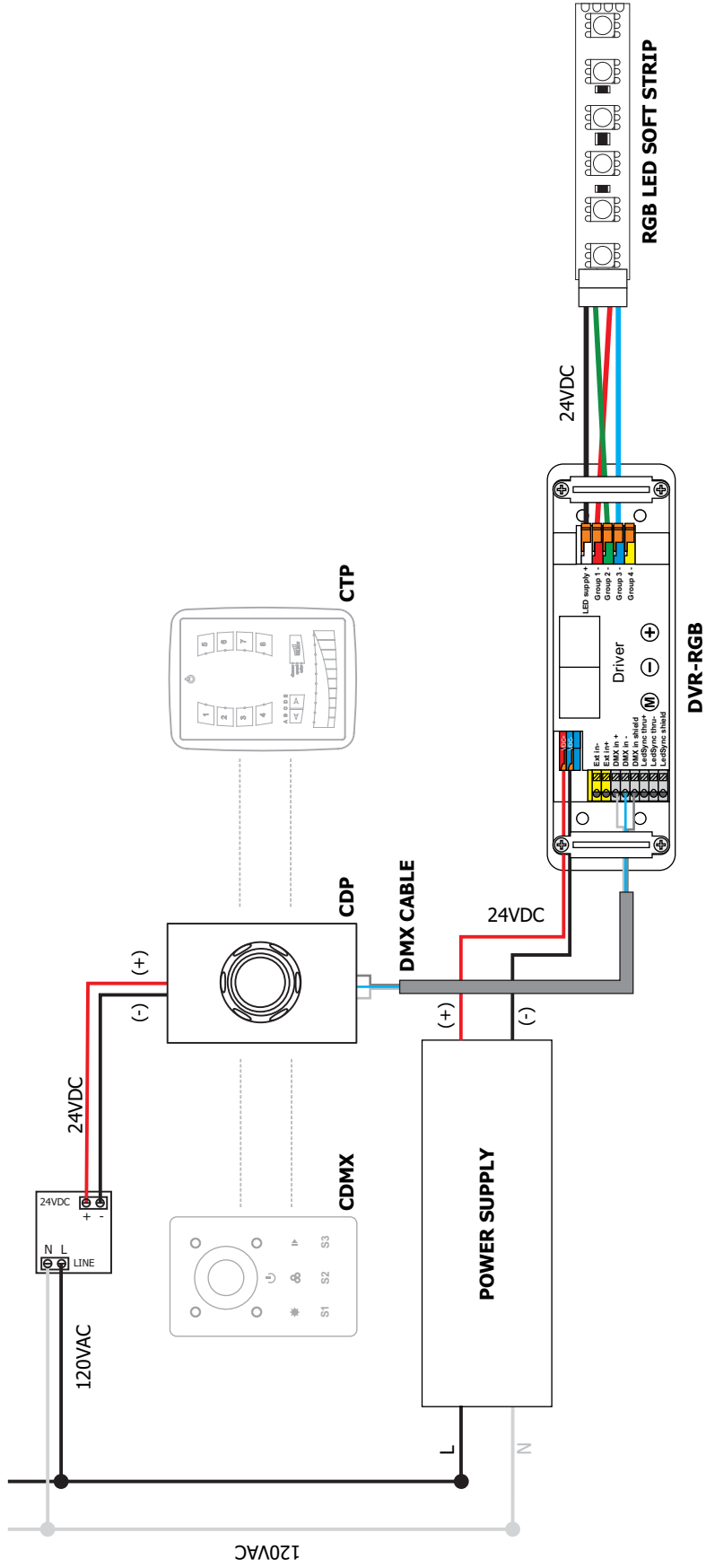

# RGB+W Configuration

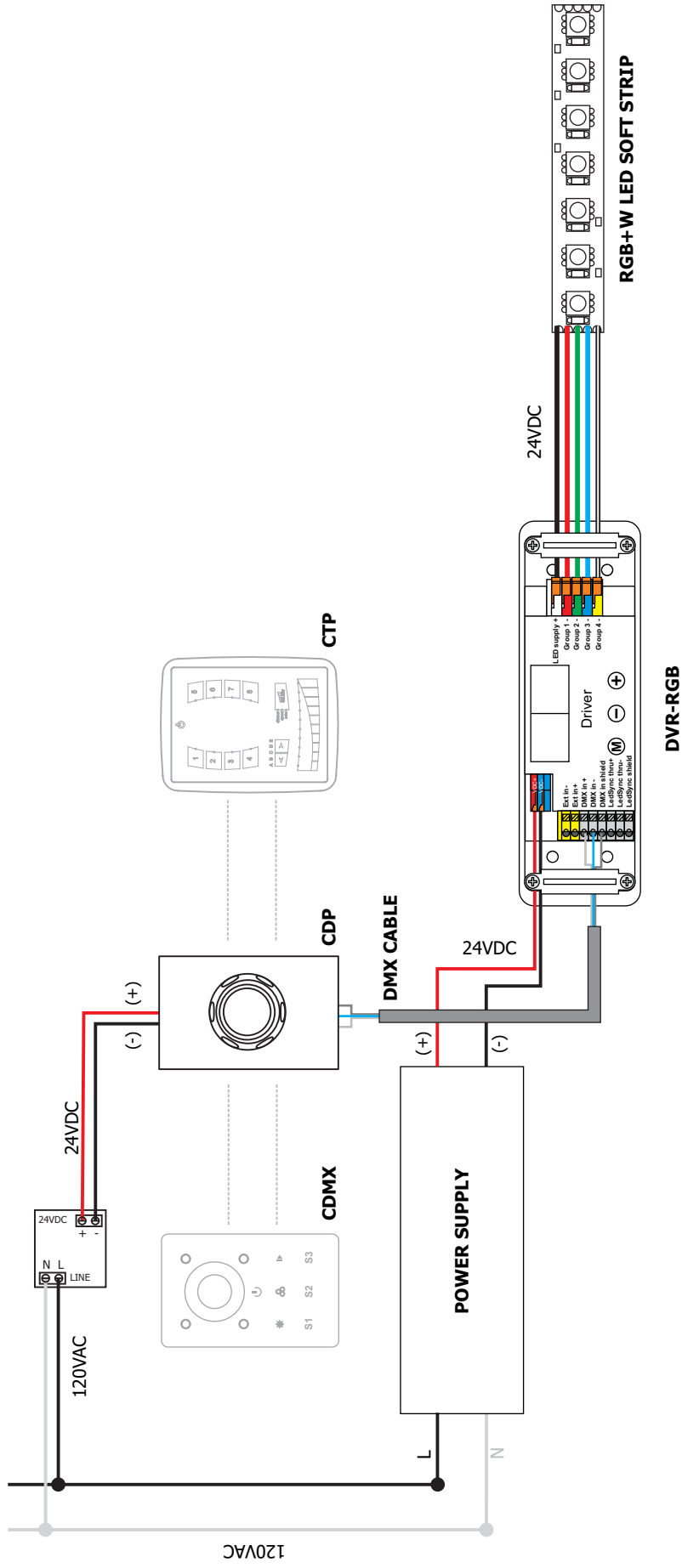



## Section Two: Alternative Driver with LED Power Supply with RGB Soft Strip

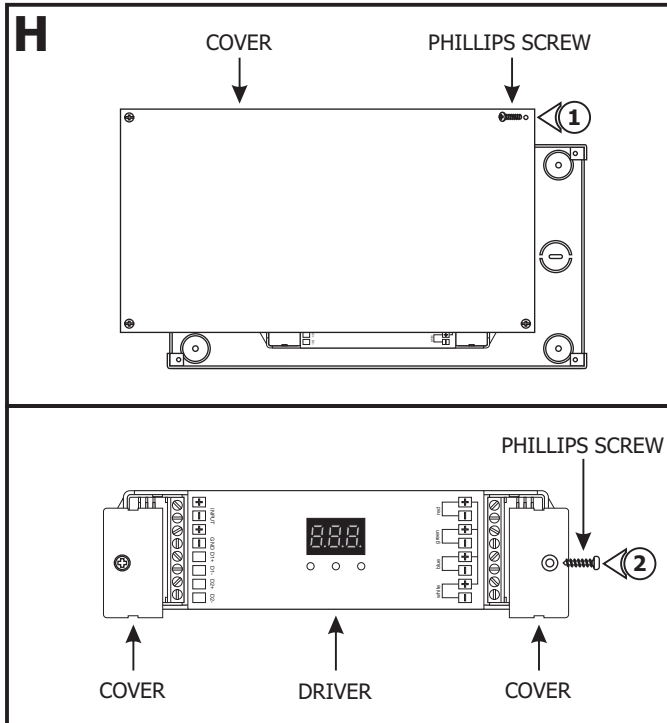

**1:** Loosen the four Phillips screws on front of the power supply to remove the cover.

**2:** Loosen the two Phillips screws on the driver to remove the cover.

**3:** Refer to steps 3 through 9 on Page 2 to connect the controller to the controller power supply, install conduits, and run the proper size line voltage wires and DMX cable wires to the power supply enclosure.

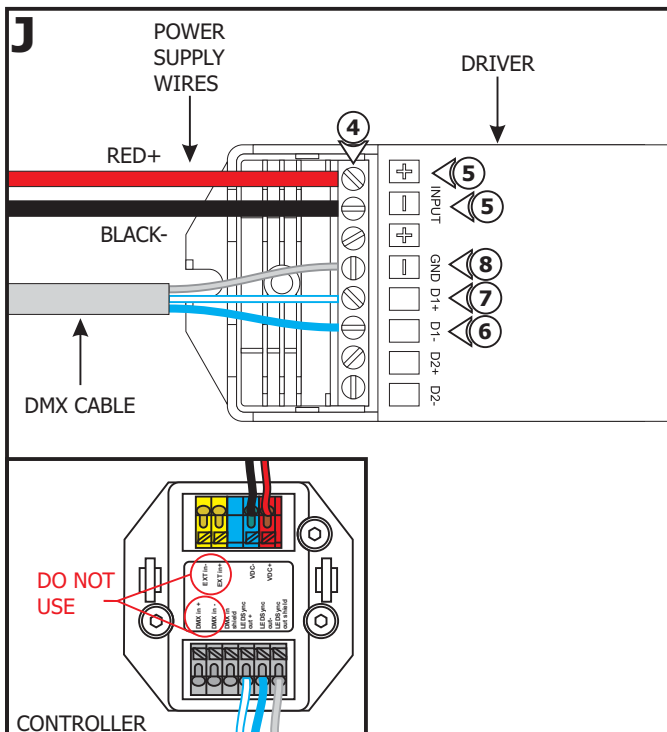
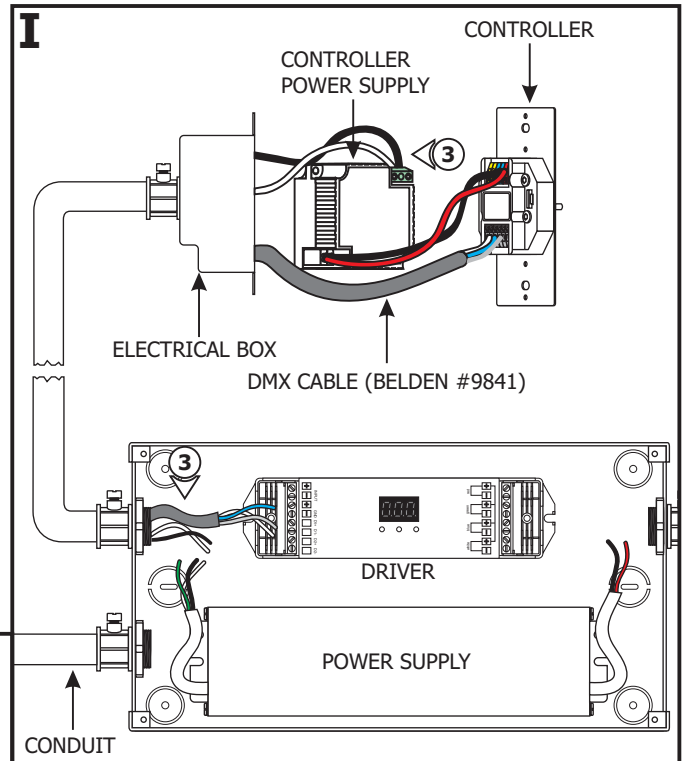

**4:** Loosen the screws on the "+ INPUT," "-INPUT," "GND," "D1+" and "D1-" terminals of the DMX driver with a flat head screw driver.

**5:** Insert the red wire from the power supply into the "+ INPUT" DMX terminal and tighten the screw. Insert the black wire from the power supply to the "- INPUT" DMX terminal and tighten the screws.

**6:** Connect one end of a data wire (blue with white stripes wire) to the "LEDSYNC OUT-" controller terminal. Insert the other end into the "D1-" DMX terminal and tighten the screw.

**7:** Connect one end of a data wire (white with blue stripes wire) to the "LEDSYNC OUT+" controller terminal. Insert the other end into the "D1+" DMX terminal and tighten the screw.

**8:** Connect one end of a data wire (bare shield wire) to the "LEDSYNC SHIELD" controller terminal. Insert the other end into the "GND" DMX terminal and tighten the screw.

**NOTE:** "DMX in+," "DMX in-," "EXT in+" & "EXT in-," controller terminals are not used on controller.

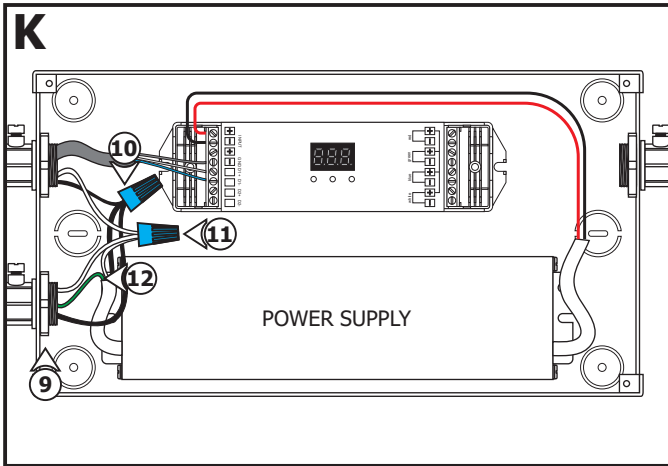

- 9:** Run the line voltage power wires to the power supply enclosure.
- 10:** Connect the hot power wire to the black power supply wire and black controller power supply wire using a wire nut.
- 11:** Connect the neutral power wire to the white power supply wire and white controller power supply wire using a wire nut.
- 12:** Make sure the green power supply wire is grounded in accordance with local electrical codes.

- NOTE:** Do not exceed the maximum wattage of the power supply.
- 13:** Use the "Low Voltage Wire Size Chart" on page 1 to determine proper wire size connecting to the DMX terminals.
  - 14:** Run the proper size black, red, green, blue, and white wires from the LED strip/fixture to the power supply enclosure.
  - 15:** Connect the black wire of the LED strip/fixture to the red "+" DMX terminal and tighten the screw.
  - 16:** Connect the red wire of the LED strip/fixture to the red "-" DMX terminal and tighten the screw.
  - 17:** Connect the green wire of the LED strip/fixture to the green "-" DMX terminal and tighten the screw.
  - 18:** Connect the blue wire of the LED strip/fixture to the blue "-" DMX terminal and tighten the screw.
  - 19: Optional:** For RGB+W, connect the white wire of the LED strip/fixture to the white "-" DMX terminal and tighten the screw.

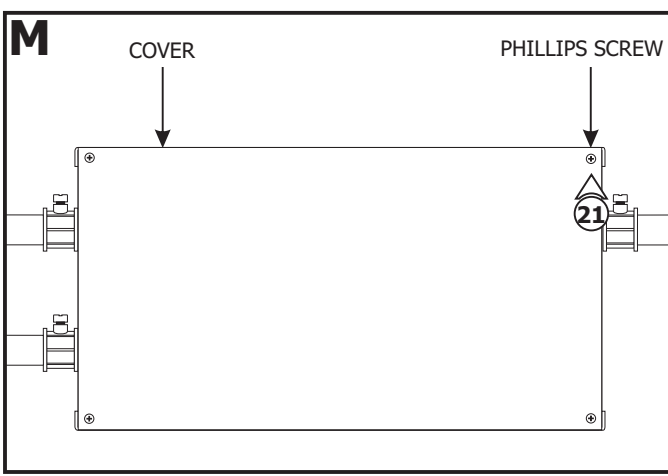
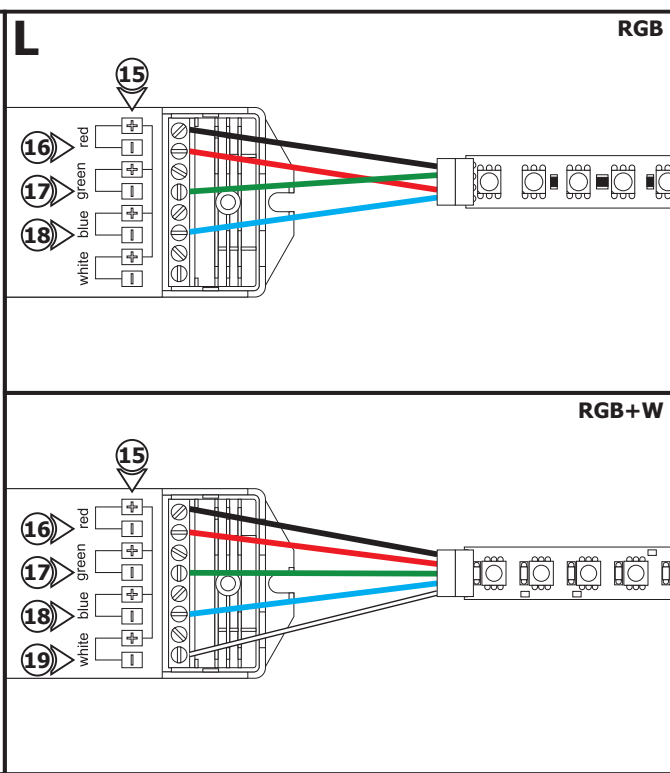

- 20:** Replace the driver covers.
- 21:** Replace the power supply cover and secure it by tightening the four Phillips screws.

# Programming Guide

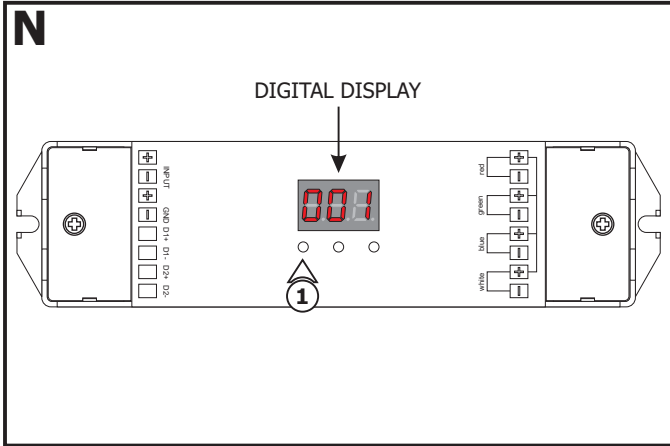

- 1:** Press and hold the first button for two seconds until the digital display flashes to choose a DMX address.
- 2:** Use the three buttons to set the DMX address.
- 3:** Press and hold any button for two seconds to confirm.

- 4:** Press and hold the second and third buttons at the same time for two seconds until the digital display flashes to choose a channel.
- 5:** Press the first button to toggle the channel to 4.
- 6:** Press and hold any button for two seconds to confirm.

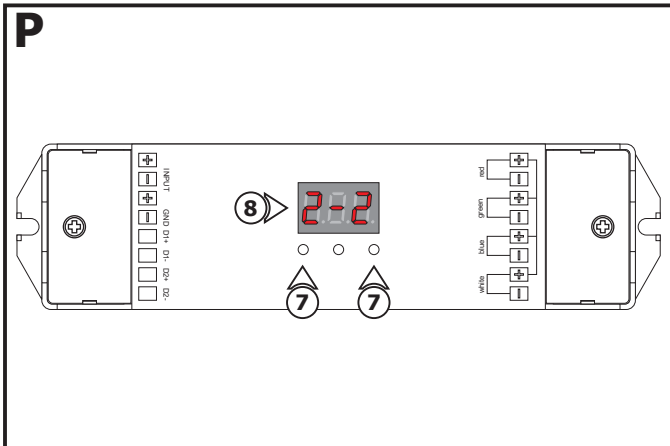
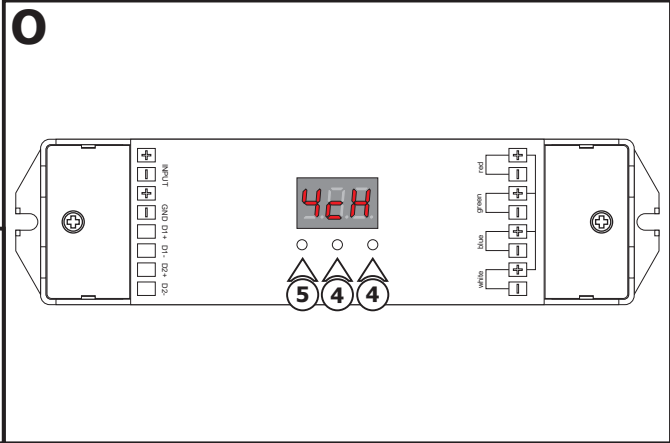

- 7:** Press and hold the first and third buttons at the same time for two seconds until the digital display flashes to enter the PWM frequency settings.
- 8:** Press the first button and toggle to 2, meaning 200Hz. Press the third button and toggle to 2, meaning linear dimming.
- 9:** Press and hold any button for two seconds to confirm.

# RGB Configuration

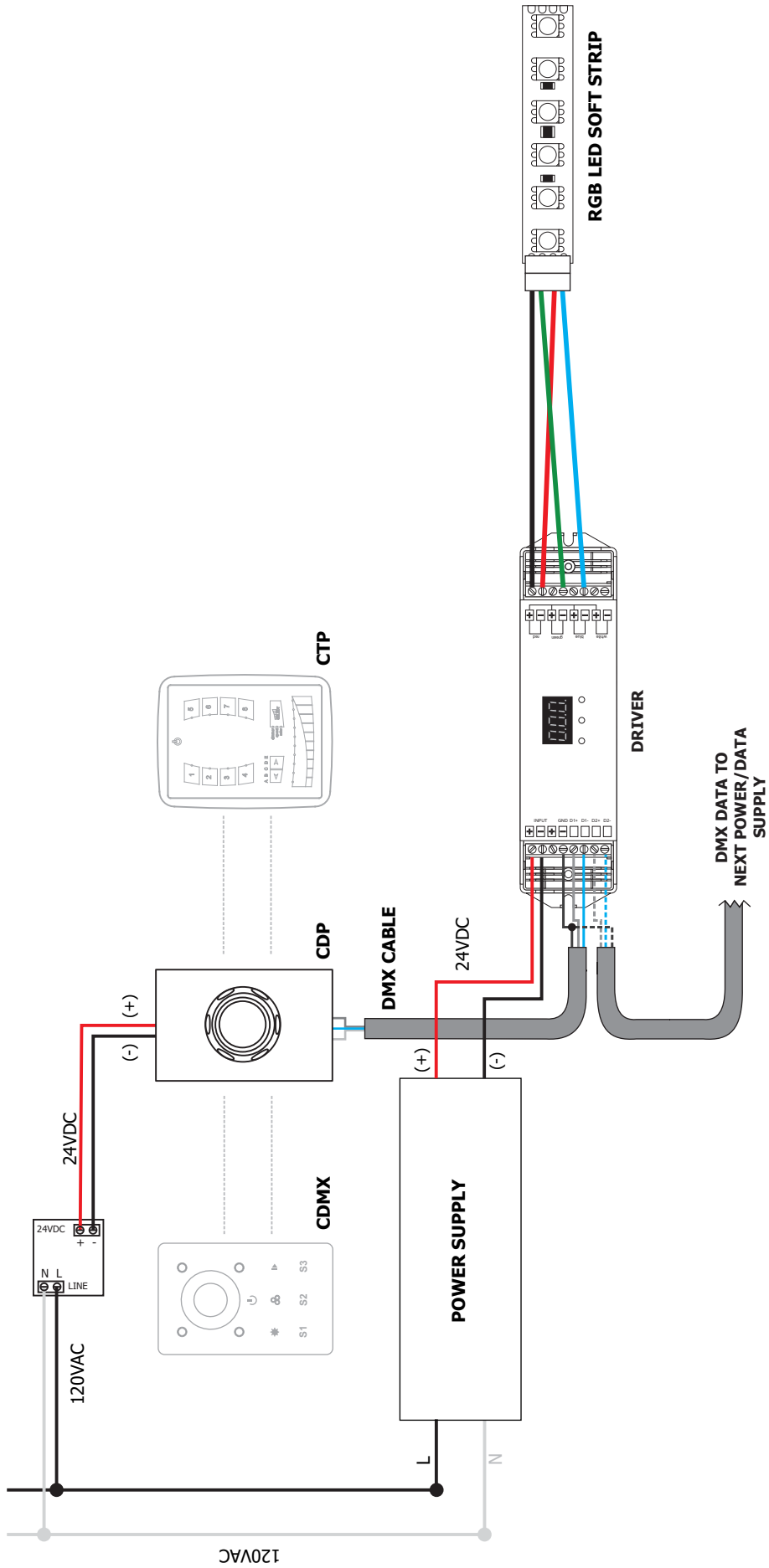

# RGB+W Configuration

