

# RADIANT LARGE TRACK HEAD

24VDC, WITH INTEGRATED LED, STATIC WHITE & WARM DIM TECHNOLOGY

DESIGNED BY GREGORY KAY | ASSEMBLED IN AMERICA

REV 06.23.22



T24-RADL-SP-30K-WH



T24-RADL-SP-30K-BK

## DESCRIPTION

The Radiant Large track head forms the perfect marriage of technology and stealth design. This 14-watt, Low Voltage 24VDC fixture is offered with your choice of beam spreads, optional field-changeable lenses available. The flat-back cylinder with a radiant heat sink swivels 90° vertically and 360° horizontally. Available in 5 color temperatures, including Warm Dim (30D), that dims from 3000K-1800K exhibiting designer-grade color rendering as high as 98 CRI and R9-92. Made from Billet Aluminum, producing a high degree of precision and maximum light output within a small package. Radiant Large is ideal for upscale residential, commercial, and retail environments. 5-year pro-rated warranty.

## MOUNTING OPTIONS

Compatible with TruTrack Recessed Track (TR24-1C, TR24-2C) Pipeline Systems including Modular Suspension, Pipeline Track Suspension with Up Light and Pipeline Stem Mount Wall/Display (P1SDM, PT, PSTU2CR, PSTU2CR) and Surface Mount track (TS24-1C)

## REMOTE POWER SUPPLIES (SOLD SEPARATELY)

24VDC, Class 2 wiring

- [Pure Smart™ WiZ Pro Power Supplies & Controls](#)
- [UNI Driver: Universal Dimming \(TRIAC, ELV, 0-10V\)](#)

In-Wall Mounting Kits available for select power supplies

## LAMPING

BEAM ANGLE REFERENCE 45°					
COLOR TEMPERATURE	24K	27K	30K	30D	35K
TOTAL LUMENS	1389	1161	1199	838	1422
WATTS	14	14	14	14	14
LUMENS PER WATT (lm/w)	99	83	86	58	102
CRI	97	92	93	97	98
TM-30 DATA	R9: 60 Rf: 93 Rg: 98	R9: 97 Rf: 92 Rg: 100	R9: 64 Rf: 91 Rg: 98	R9: 90 Rf: 95 Rg: 102	R9: 92 Rf: 94 Rg: 101
LAMP LIFE	60,000 Hours, 70% Lumen Maintenance				

## ACCESSORIES

Additional lenses can be ordered and changed in the field offered in **NS** (10°), **SP** (20°), **NF** (35°), **FL** (45°), **WF** (60°) beam spread options.

## APPLICATIONS

Designed for indoor use only, dry and damp locations. Ideal applications in Commercial, Retail, Residential, Hospitality, Education, and Healthcare Institutions.

## WARRANTY / LABELS

Pro-rated 5 year warranty. Assembled in America, ETL (Conforms to UL1598 and CSA 22.2 #250.0) RoHs, Title 24 JA8 with universal power supplies 27K> CCT.

## FINISHES



Black  
BK

White  
WH

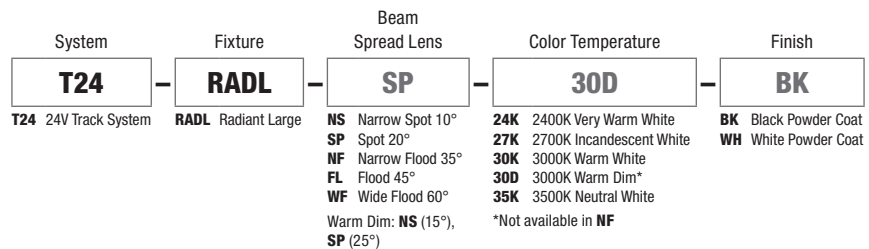
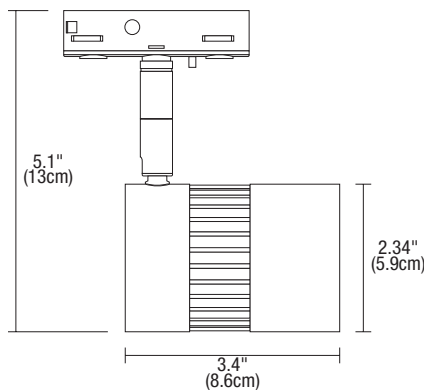





PROJECT	FIXTURE TYPE	DATE
---------	--------------	------

# RADIANT LARGE TRACK HEAD

24VDC, WITH INTEGRATED LED, STATIC WHITE & WARM DIM TECHNOLOGY

REV 06.23.22

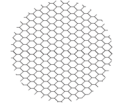
## Additional Lenses and Accessories

	RADIANT LARGE LENS		SNOOT	LOUVER	FOCUS LENS	LINEAR SPREAD FILM
						
<b>ORDERING CODE</b>	<b>STATIC WHITE</b> LEN-RADL-NS-SW LEN-RADL-SP-SW LEN-RADL-NF-SW LEN-RADL-FL-SW LEN-RADL-WF-SW	<b>WARM DIM</b> LEN-RADL-NS-WD LEN-RADL-SP-WD LEN-RADL-FL-WD LEN-RADL-WF-WD	<b>STB16-BK</b> <b>STB16-WH (WHITE SHELL)</b>	<b>LO16-H</b>	<b>LF-RADL-SF (SOFT FOCUS),</b> <b>MF (MEDIUM FOCUS),</b> <b>WF (WIDE FOCUS)</b>	<b>LF-RADL-LS</b>
<b>LENS SIZE</b>	2" (50mm) Diameter					
<b>BEAM SPREADS</b>	<b>NS (10°), SP (20°),</b> <b>NF (35°), FL (45°),</b> <b>WF (60°)</b>	<b>NS (15°), SP (25°),</b> <b>FL (45°), WF (60°)</b>	Conical snoot creates a 7° Beam spread and is designed to reduce spill and control glare. Spun aluminum.	Hexcell louver eliminates glare. 0.125" Thickness.	Soft focus lens is included with every track head. Diffuses the beam, providing uniform illumination.	Linear spread film: directs the light into an elongated beam. Typical applications using 10°, 15°, 25° include illuminating landscape oriented art. 35°, 40°, 60° create an elongated oval typically used for wall washing.

## RADIANT LARGE Photometric Data using 3000K CCT

D' - Distance from RADIANT LARGE fixture  
 FC - Initial foot candles at the center of beam  
 DIA - Diameter

### NARROW SPOT BEAM ANGLE 10°

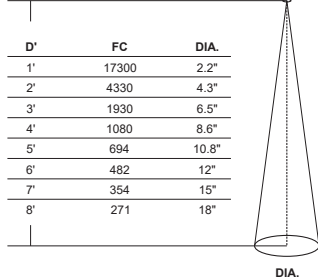

### SPOT BEAM ANGLE 20°

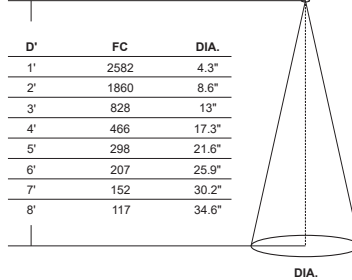

### NARROW FLOOD BEAM ANGLE 35°

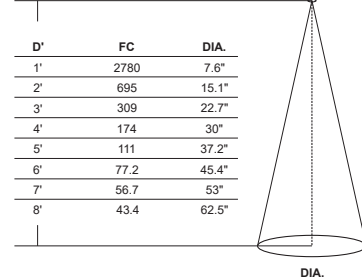

### FLOOD BEAM ANGLE 45°

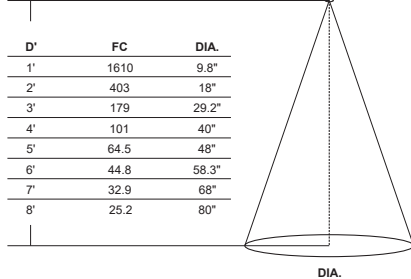

### WIDE FLOOD BEAM ANGLE 60°

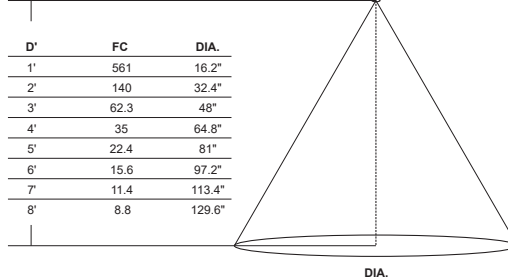

PROJECT		FIXTURE TYPE		DATE	
---------	--	--------------	--	------	--

# CEILING TM30 DATA

24VDC, WITH INTEGRATED LED, STATIC WHITE & WARM DIM TECHNOLOGY

**TM-30-15 DATA:** The data below is for Radiant Large. Consistent color temperatures among multiple track heads is possible through a 3 phase binning process in which each order is inspected with a color meter to ensure uniformity.

**2400K** | Rf: 91.0 | Rg: 99.6

Color Vector Graphic

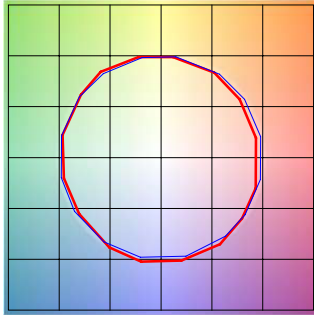

■ Test ■ Reference

		GRAPHIC SHIFTS %	
HUE BIN	Rf	CHROMA	HUE
1	90.1	-4.6%	-0.3%
2	90.6	-4.0%	2.7%
3	88.6	-1.6%	5.1%
4	93.1	-0.9%	2.7%
5	94.6	1.1%	3.3%
6	94.6	2.9%	1.0%
7	94.1	-0.2%	-2.7%
8	97.1	-0.9%	-1.2%
9	94.5	-2.4%	1.0%
10	90.3	-2.5%	4.5%
11	88.6	1.5%	7.1%
12	89.2	4.1%	1.5%
13	90.6	3.4%	-5.3%
14	84.5	3.5%	-8.9%
15	92.3	-0.5%	-4.7%
16	85.4	-2.9%	-9.4%

**2700K** | Rf: 93.3 | Rg: 98.8

Color Vector Graphic

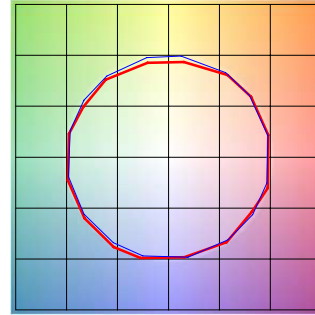

■ Test ■ Reference

		GRAPHIC SHIFTS %	
HUE BIN	Rf	CHROMA	HUE
1	95.9	0.3%	0.7%
2	95.5	0.6%	-2.0%
3	93.7	-0.8%	-2.8%
4	89.8	-5.2%	-4.0%
5	93.1	-5.2%	0.2%
6	93.9	-2.4%	2.9%
7	89.0	-3.1%	5.5%
8	93.6	0.5%	3.7%
9	92.9	1.2%	3.8%
10	92.7	2.0%	3.9%
11	93.7	3.2%	2.9%
12	93.7	2.7%	-1.8%
13	94.9	-0.7%	-3.4%
14	94.7	1.3%	-2.4%
15	92.9	-2.1%	2.0%
16	92.2	1.7%	-5.0%

**3000K** | Rf: 90.5 | Rg: 98.0

Color Vector Graphic

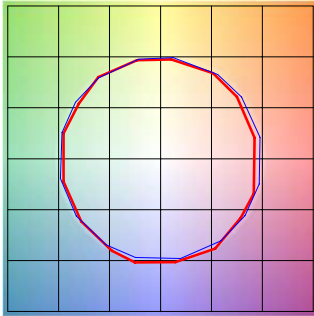

■ Test ■ Reference

		GRAPHIC SHIFTS %	
HUE BIN	Rf	CHROMA	HUE
1	88.7	-5.3%	0.5%
2	90.7	-3.6%	2.8%
3	89.4	-1.7%	4.6%
4	93.3	-2.1%	1.4%
5	94.6	-0.8%	2.2%
6	96.2	0.6%	-0.2%
7	92.5	-3.4%	-0.9%
8	96.4	-1.7%	0.5%
9	92.0	-2.4%	3.7%
10	87.3	-1.1%	7.1%
11	87.6	1.7%	8.2%
12	89.2	4.8%	0.4%
13	90.6	2.5%	-5.7%
14	86.7	3.3%	-9.0%
15	90.9	-2.4%	-3.9%
16	84.1	-3.5%	-10.3%

**3500K** | Rf: 93.9 | Rg: 100.9

Color Vector Graphic

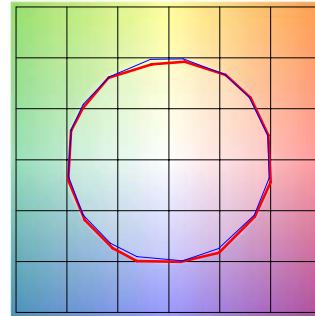

■ Test ■ Reference

		GRAPHIC SHIFTS %	
HUE BIN	Rf	CHROMA	HUE
1	95.7	0.6%	0.3%
2	96.7	0.8%	-1.2%
3	96.0	0.2%	-1.0%
4	94.3	-2.5%	-1.9%
5	93.2	-4.8%	-0.2%
6	97.1	-0.3%	1.4%
7	93.8	-1.7%	3.2%
8	97.3	0.2%	1.3%
9	93.3	0.8%	4.2%
10	91.4	1.4%	5.2%
11	90.6	2.8%	4.5%
12	92.6	4.4%	0.5%
13	96.3	0.7%	-1.9%
14	93.9	3.6%	-1.8%
15	92.4	1.2%	-0.9%
16	91.5	2.3%	-3.3%

**3000D** | Rf: 90.5 | Rg: 98.0

Color Vector Graphic

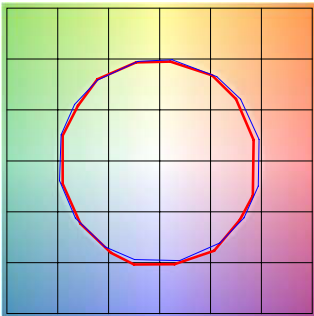

■ Test ■ Reference

		GRAPHIC SHIFTS %	
HUE BIN	Rf	CHROMA	HUE
1	88.7	-5.3%	0.5%
2	90.7	-3.6%	2.8%
3	89.4	-1.7%	4.6%
4	93.3	-2.1%	1.4%
5	94.6	-0.8%	2.2%
6	96.2	0.6%	-0.2%
7	92.5	-3.4%	-0.9%
8	96.4	-1.7%	0.5%
9	92.0	-2.4%	3.7%
10	87.3	-1.1%	7.1%
11	87.6	1.7%	8.2%
12	89.2	4.8%	0.4%
13	90.6	2.5%	-5.7%
14	86.7	3.3%	-9.0%
15	90.9	-2.4%	-3.9%
16	84.1	-3.5%	-10.3%

PROJECT	FIXTURE TYPE	DATE
---------	--------------	------