

PIX STICKS CIRRUS WITH REMOTE POWER

STATIC WHITE AND WARM DIM TECHNOLOGY

DESIGNED BY GREGORY KAY | ASSEMBLED IN AMERICA

REV 03.11.20

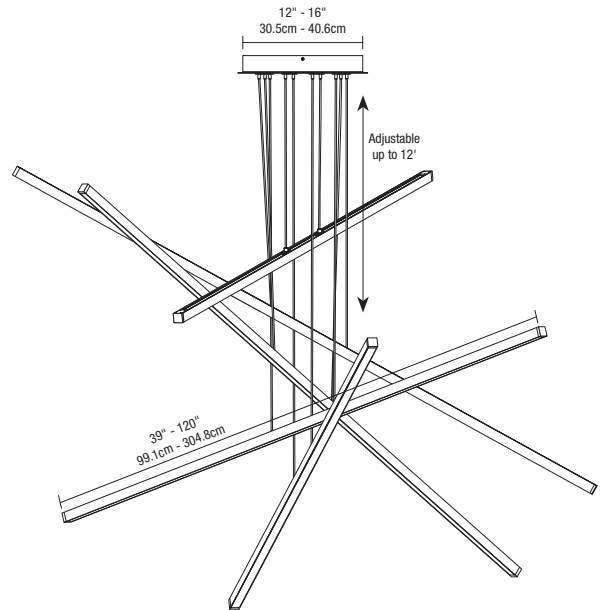

DESCRIPTION

With sleek, intersecting lines of light and a variety of high-tech options, the Pix Sticks Cirrus Suspension is a customizable mobile for the modern home, office, restaurant, or commercial area. Choose from 2 - 9 sticks from 39" to 96" in length and 3 different lens shapes. Next, select from 8 color temperatures, all downlit through Diffused White lenses, choose between Direct flat (D1), Tubular (T1), or Rectangular (R1). Optional Warm Dim technology comes in both 2700K (27D) and 3000K (30D), allowing you to dial in the familiar glow of a dim incandescent or halogen light down to 2000K. 6 channel finish options of Satin Nickel, Chrome, Antique Bronze, Satin Black, Satin Brass (with Black canopy and wires), and White to complete the look. Each fixture comes with 12 feet of adjustable cable. Contains high 85+ or 92+ CRI LEDs. Comes with metal canopy (12" for 2 - 5 stick fixtures or 16" for 6 - 9 stick fixtures). Remote power allows for easier replacement in hard-to-reach spaces such as atriums. For custom designs and quotes, send drawings to design@PureEdgeLighting.com

ELECTRICAL:

Power Supply:	Remote 24VDC Universal Power Supply, Lutron Hi-Lume® Class 2 (Not Included)* see wattage Chart Pg 3 and pgs 4-10 power supply (order separately)
Power Consumption:	5 or 7 Watts
LEDs per Foot:	Static White 35, Warm Dim 35+35 70 total LED's
Dimming:	ELV, 0-10V, TRIAC, Hi-Lume® (Ordered Separately)
Average LED life:	60,000 hrs
Approvals:	Class 2 Wiring, Damp Location Suitable, ETL listed. Made in America.
Warranty:	PureEdge's 5-Year pro-rated warranty is backed by over 30 years of precision lighting manufacturing and design

*In-Wall Mounting Kits available for select power supplies

FINISHES



System	Lens	Wattage Per Foot	Nominal Size In Inches (Per Channel)	Color Temperature	Finish
PX2	D1	5W	39	20K	SN
PX2 Pix Sticks Cirrus 2-Light, with Remote Power PX3 Pix Sticks Cirrus 3-Light, with Remote Power PX4 Pix Sticks Cirrus 4-Light, with Remote Power PX5 Pix Sticks Cirrus 5-Light, with Remote Power PX6 Pix Sticks Cirrus 6-Light, with Remote Power PX7 Pix Sticks Cirrus 7-Light, with Remote Power PX9 Pix Sticks Cirrus 9-Light, with Remote Power	D1 Direct 0.9" Lens T1 Tubular 1.13" Lens R1 Rectangle 0.9" Lens	5W 4.4 Watt 7W 7.3 Watt	39, 41, 44, 46, 48, 51, 53, 56, 58, 60, 63, 65, 68, 70, 72, 75, 77, 80, 82, 84*, 87, 89, 92, 94, 96 *Chrome, maximum length 84"	20K 2000K Sunset 22K 2200K Amber Static White 24K 2400K Very Warm Static White 27K 2700K Incandescent Static White 27D 2700K Warm Dim to 2000K (5W Only) 30K 3000K Warm Static White 30D 3000K Warm Dim to 2000K (5W Only) 35K 3500K Neutral Static White 40K 4000K Cool Static White 57K 5700K Daylight Static White	SN Satin Nickel CH Chrome BZ Antique Bronze BK Satin Black WH White SB Satin Brass

PROJECT	FIXTURE TYPE	DATE
---------	--------------	------

LAMP DATA Lamp Data for each Channel Type

PX5-D1																
PIX STICK CIRRUS WITH D1 LENS																
DESCRIPTION	5W (4.4 watts)									7W (7.3 watts)						
WATTS PER FOOT	5W (4.4 watts)									7W (7.3 watts)						
COLOR TEMPERATURE	22K	24K	27K	27D*	30K	27D*	35K	40K	57K	22K	24K	27K	30K	35K	40K	57K
LUMENS PER FOOT (lm/ft)	195	126.5	238	236	260	259	298	324	345	307	340.5	374	409	469	509	542
LUMENS PER WATT (lm/w)	44	49	54	49	59	54	68	74	78	42	93	51	56	64	70	74
CRI	85+	90+	95+	95+	95+	95+	85+	84	84	85+	90+	95+	95+	85+	84	84

*27D, 30D - Warm Dim (4.8 Watts)

PX5-T1																
PIX STICK CIRRUS WITH T1 LENS																
DESCRIPTION	5W (4.4 watts)									7W (7.3 watts)						
WATTS PER FOOT	5W (4.4 watts)									7W (7.3 watts)						
COLOR TEMPERATURE	22K	24K	27K	27D*	30K	27D*	35K	40K	57K	22K	24K	27K	30K	35K	40K	57K
LUMENS PER FOOT (lm/ft)	229	254.5	280	316	306	345	350	380	405	364	404	444	485	556	604	643
LUMENS PER WATT (lm/w)	52	58	64	72	69	78	80	86	92	50	55.5	61	66	76	83	88
CRI	85+	90+	95+	95+	95+	95+	85+	84	84	85+	90+	95+	95+	85+	84	84

*27D, 30D - Warm Dim (4.8 Watts)

PX5-R1																
PIX STICK CIRRUS WITH R1 LENS																
DESCRIPTION	5W (5 watts)									7W (7.5 watts)						
WATTS PER FOOT	5W (5 watts)									7W (7.5 watts)						
COLOR TEMPERATURE	22K	24K	27K	27D*	30K	27D*	35K	40K	57K	22K	24K	27K	30K	35K	40K	57K
LUMENS PER FOOT (lm/ft)	239	265	291	329	318	359	364	396	422	379	420.5	462	505	579	629	670
LUMENS PER WATT (lm/w)	54	60	66	75	72	82	83	90	96	52	57.5	63	69	79	86	92
CRI	85+	90+	95+	95+	95+	95+	85+	84	84	85+	90+	95+	95+	85+	84	84

*27D, 30D - Warm Dim (4.8 Watts)

ACTUAL LENGTHS: Actual Channel Lengths for Pix Sticks Cirrus with Remote Power

PIX STICK CIRRUS SUSPENSION WITH REMOTE POWER - ACTUAL SIZES		
Ordering code (Nominal Size)	Wood channel Overall Length (Inches)	Metal channel Overall Length (Inches)
39	39.9	39.5
48	49.5	49.1
60	61.5	61.1
72	73.5	73.1
84	85.5	85.1
96	97.5	97.1
108	107.5	107
120	119.5	119

LENS OPTIONS: D1, T1, and R1 Lens Options for Pix Stick Cirrus

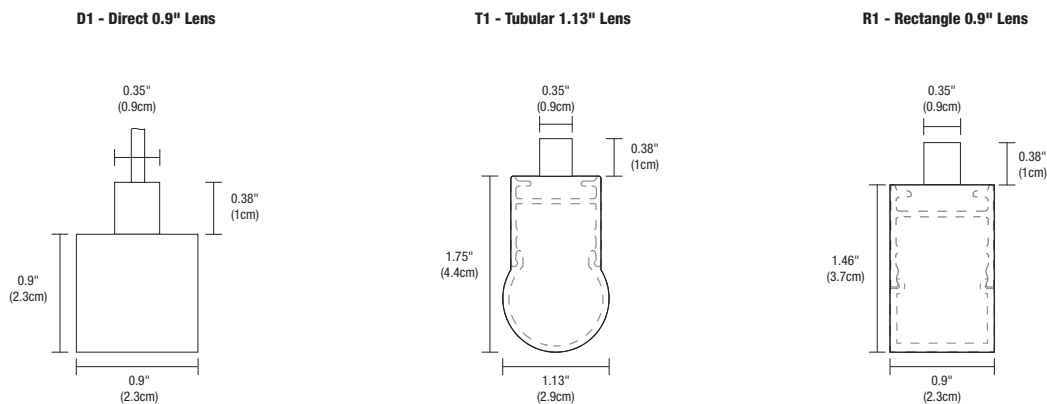

PROJECT	FIXTURE TYPE	DATE
---------	--------------	------

PIX STICKS CIRRUS WITH REMOTE POWER

STATIC WHITE AND WARM DIM TECHNOLOGY

ACTUAL LENGTHS: Actual Channel Wattage per Channel

CHANNELS	5 WATTS	LENGTH	TOTAL WATTAGE
2	5	39"	32.5
2	5	48"	40
2	5	60"	50
2	5	72"	60
2	5	84"	70
2	5	96"	80

CHANNELS	5 WATTS	LENGTH	TOTAL WATTAGE
2	7	39"	45.5
2	7	48"	56
2	7	60"	70
2	7	72"	84
2	7	84"	98
2	7	96"	112

3	5	39"	48.75
3	5	48"	60
3	5	60"	75
3	5	72"	90
3	5	84"	105
3	5	96"	120

3	7	39"	68.25
3	7	48"	84
3	7	60"	105
3	7	72"	126
3	7	84"	147
3	7	96"	168

4	5	39"	65
4	5	48"	80
4	5	60"	100
4	5	72"	120
4	5	84"	140
4	5	96"	160

4	7	39"	91
4	7	48"	112
4	7	60"	140
4	7	72"	168
4	7	84"	196
4	7	96"	224

5	5	39"	81.25
5	5	48"	100
5	5	60"	125
5	5	72"	150
5	5	84"	175
5	5	96"	200

5	7	39"	113.75
5	7	48"	140
5	7	60"	175
5	7	72"	210
5	7	84"	245
5	7	96"	280

6	5	39"	97.5
6	5	48"	120
6	5	60"	150
6	5	72"	180
6	5	84"	210
6	5	96"	240

6	7	39"	136.5
6	7	48"	168
6	7	60"	210
6	7	72"	252
6	7	84"	294
6	7	96"	336

7	5	39"	113.75
7	5	48"	140
7	5	60"	175
7	5	72"	210
7	5	84"	245
7	5	96"	280

7	7	39"	159.25
7	7	48"	196
7	7	60"	245
7	7	72"	294
7	7	84"	343
7	7	96"	392

9	5	39"	146.25
9	5	48"	180
9	5	60"	225
9	5	72"	270
9	5	84"	315
9	5	96"	360

9	7	39"	204.75
9	7	48"	252
9	7	60"	315
9	7	72"	378
9	7	84"	441
9	7	96"	504

PROJECT		FIXTURE TYPE		DATE	
---------	--	--------------	--	------	--

IN WALL MOUNTING OPTIONS

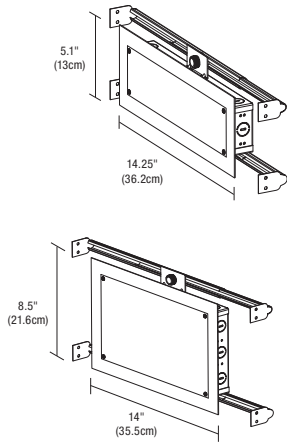

In-Wall Mounting Kit: Includes power supply, box cover and stud hangers for installing Junction Box in wall. Select "IW" in the options section of compatible power supply ordering codes if an In-Wall Mounting Kit is needed.

Ordering Codes 5.1 x 14.25 inch: PSB-40W-UNI-24VDC-IW
PSB-60W-UNI-24VDC-IW
PSB-96W-UNI-24VDC-IW

Ordering Codes 8.5 x 14.25 inch: PSB-2X40W-UNI-24VDC-IW
PSB-2X60W-UNI-24VDC-IW
PSB-2X96W-UNI-24VDC-IW

WIRING DIAGRAMS UNIVERSAL POWER SUPPLY

Application: Triac dimming for two power supplies, use for Static White, Dynamic/Tunable White 2000K-4000K

Dimming: Dimmable with Triac dimmer: Lutron: Skylark S2-L

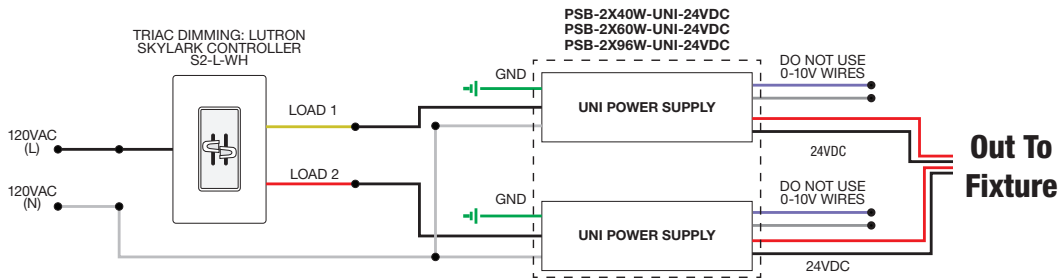

Application: ELV dimming for Static White and Warm Dim

Dimming: Dimmable with ELV dimmer: Legrand, Adorne ADTP703TU; Lutron: Diva DVELV-300P, Skylark SELV-300P, Maestro MAELV-600 and Radio Ra 2

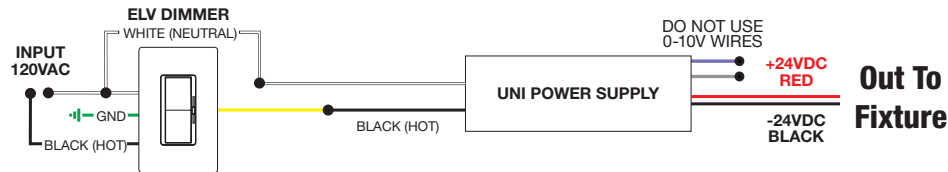

Application: 0-10V dimming for Static White

Dimming: Dimmable with 0-10V dimmer: Philips Sunrise: SR1200ZTUNV; Lutron Diva: DVTV-WH, DVSTV-WH; Lutron Nova T: NTSTV-DV-XX; Lutron Grafix EYE QS: QSGRJ-XP; Lutron Radio Ra2: RRD-10ND; Leviton: LEV40050; Leviton IP710-LFZ; Legrand: ADPD4FBL3P2W4

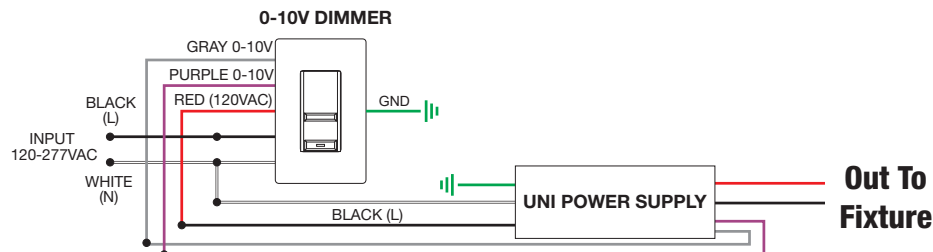

PROJECT		FIXTURE TYPE		DATE	
---------	--	--------------	--	------	--

ELECTRONIC LOW-VOLTAGE (ELV) POWER SUPPLIES & RECOMMENDED DIMMERS ^{†‡}				
ORDERING CODES	PS-60L-ELV-24VDC 	PSB-60W-ELV-24VDC 	PSB-2X60W-ELV-24VDC 	PSB-100W-ELV-24VDC
SPECIFICATIONS				
MAXIMUM LOAD	60W NON-IC, 50W-IC (FITS IN JBOX)	60W	2X60W	96W
INPUT VOLTAGE	120VAC	120VAC	120VAC	120VAC
OUTPUT VOLTAGE	24VDC	24VDC	24VDC	24VDC
DIMENSIONS	2.25" X 1.25" X 0.83"	8.125" X 2" X 1.75"	12.15" X 6.48" X 2.18"	9.25" X 3.5" X 2"
CLASSIFICATION	CLASS 2	CLASS 2	CLASS 2	CLASS 2
IN WALL MOUNTING	N/A	PSB-60W-ELV-24VDC-IW	PSB-2X60W-ELV-24VDC-IW	PSB-100W-ELV-24VDC-IW
ELECTRONIC LOW-VOLTAGE (ELV) POWER SUPPLIES & RECOMMENDED DIMMERS ^{†‡}				
ORDERING CODES	PSB-2X100W-ELV-24VDC 	PSB-3X100W-ELV-24VDC 	PSB-4X100W-ELV-24VDC 	
SPECIFICATIONS				
MAXIMUM LOAD	2X96W	3X96W	4X96W	
INPUT VOLTAGE	120VAC	120VAC	120VAC	
OUTPUT VOLTAGE	24VDC	24VDC	24VDC	
DIMENSIONS	12.15" X 6.48" X 2.18"	14" X 10" X 3"	17" X 13" X 3"	
CLASSIFICATION	CLASS 2	CLASS 2	CLASS 2	
IN WALL MOUNTING	PSB-2X100W-ELV-24VDC-IW	N/A	N/A	
DIMMING AND CONTROLS				
LUTRON DIVA: DVELV-300P	•	•	•	
LUTRON SKYLARK: SELV-300P	•	•	•	
LUTRON RADIO RA2: RRD-6NA	•	•	•	
LUTRON MAESTRO: MAELV-600	•	•	•	
LEGRAND ADORNE: ADTP-703TUM4	•	•	•	

[†]22K - 57K color temperatures are compatible with 0-10V, ELV, and Lutron Hi-lume® Power Supplies. Warm Dim (27D, 30D) color temperatures are only compatible with ELV power supplies. Tunable White (2K4K) color temperature is compatible with 0-10V, ELV, DMX, and Lutron Hi-lume® Power Supplies. Dynamic Color (RGB, RGB+W) and Static Color (Amber, Blue, Green, or Red) are compatible with DMX Power Supplies.

[‡]Electrical Panels using Siemens/Murray AFCI breakers are not compatible with this ELV transformer. Use 0-10 Volt power supplies with this breaker

With N-Lite Dimming Do not use ELV power supplies, use only 0-10 volt or Uni drivers power supplies

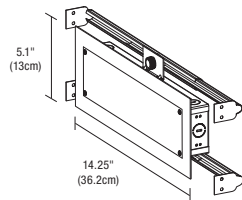

5.1 x 14.25 inch In-Wall Mounting Kit: Includes power supply, box cover and stud hangers for installing Junction Box in wall. Select "IW" in the options section of compatible power supply ordering codes if an In-Wall Mounting Kit is needed.

Ordering Codes: PSB-60W-ELV-24VDC-IW
PSB-100W-ELV-24VDC-IW

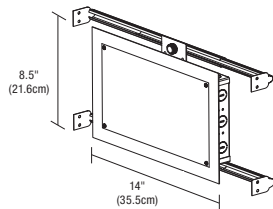

8.5 x 14 inch In-Wall Mounting Kit: Includes power supply, box cover and stud hangers for installing Junction Box in wall. Select "IW" in the options section of compatible power supply ordering codes if an In-Wall Mounting Kit is needed.

Ordering Codes: PSB-2X60W-ELV-24VDC-IW
PSB-2X100W-ELV-24VDC-IW

PROJECT		FIXTURE TYPE		DATE	
---------	--	--------------	--	------	--

SAMPLE WIRING DIAGRAMS 24VDC ELV

Application: ELV dimming for Static White

Dimming: Dimmable with ELV dimmer: Legrand, Adorne ADTP703TU; Lutron: Diva DVELV-300P, Skylark SELV-300P, Maestro MAELV-600 and Radio Ra 2

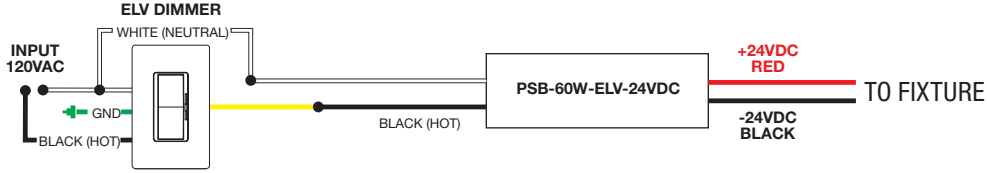

Application: ELV dimming for Static White

Dimming: Dimmable with ELV dimmer: Legrand, Adorne ADTP703TU; Lutron: Diva DVELV-300P, Skylark SELV-300P, Maestro MAELV-600 and Radio Ra 2

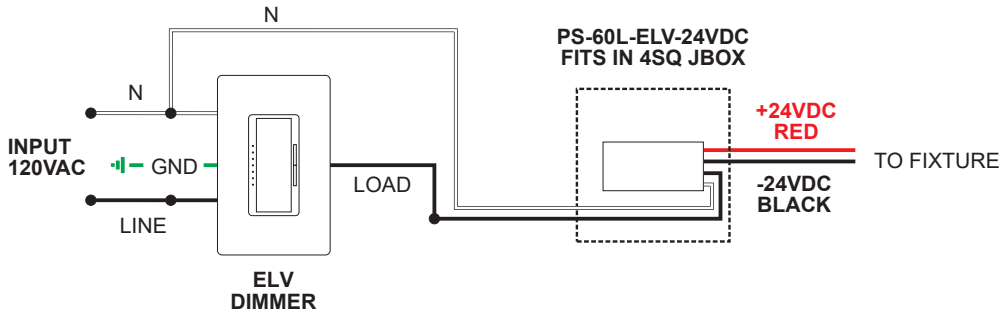





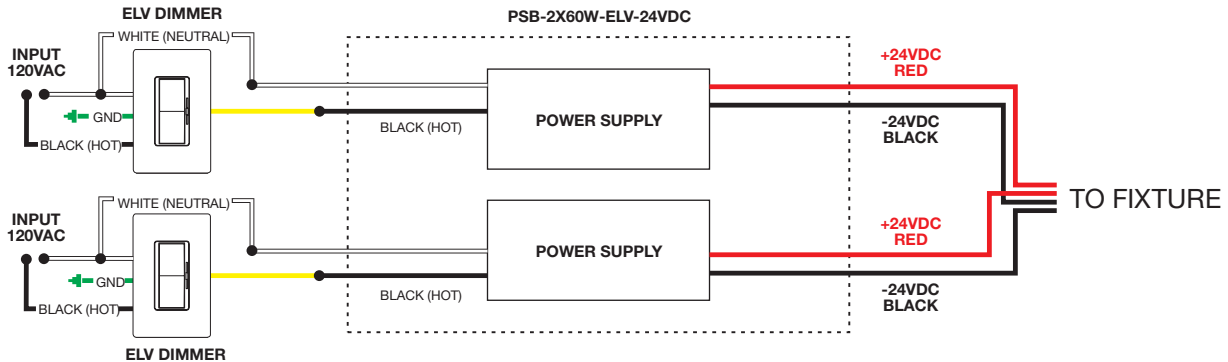

Application: Dual ELV dimming for Dynamic/Tunable White 2000K-4000K

Dimming: Dimmable with ELV dimmer: Legrand, Adorne ADTP703TU; Lutron: Diva DVELV-300P, Skylark SELV-300P, Maestro MAELV-600 and Radio Ra 2



PROJECT		FIXTURE TYPE		DATE	
---------	--	--------------	--	------	--

0-10 VOLT (010) POWER SUPPLIES & RECOMMENDED DIMMERS†				
ORDERING CODE	PSB-25W-010-24VDC 	PSB-60W-010-24VDC 	PSB-96W-010-24VDC 	PSB-2X96W-010-24VDC 
SPECIFICATIONS				
MAXIMUM LOAD	25W	60W	96W	2X96W
INPUT VOLTAGE	120VAC	120-277VAC	120-277VAC	120-277VAC
OUTPUT VOLTAGE	24VDC	24VDC	24VDC	24VDC
DIMENSIONS	12.4" X 3.12" X 2.18"	12.4" X 3.12" X 2.18"	12.4" X 3.12" X 2.18"	12.15" X 6.48" X 2.18"
CLASSIFICATION	CLASS 2	CLASS 2	CLASS 2	CLASS 2
IN-WALL MOUNTING	PSB-25W-010-24VDC-IW	PSB-60W-010-24VDC-IW	PSB-96W-010-24VDC-IW	PSB-2X96W-010-24VDC-IW
0-10 VOLT (010) POWER SUPPLIES & RECOMMENDED DIMMERS†				
ORDERING CODE	PSB-3X96W-010-24VDC 		PSB-4X96W-010-24VDC 	
SPECIFICATIONS				
MAXIMUM LOAD	3X96W		4X96W	
INPUT VOLTAGE	120-277VAC		120-277VAC	
OUTPUT VOLTAGE	24VDC		24VDC	
DIMENSIONS	14" X 10" X 3"		17" X 13" X 3"	
CLASSIFICATION	CLASS 2		CLASS 2	
IN-WALL MOUNTING	N/A		N/A	
DIMMING & CONTROLS				
PHILIPS SUNRISE: SR1200ZTUNV	•		•	
LUTRON DIVA: DVTV-WH, DVSTV-WH	•		•	
LUTRON NOVA T: NTSTV-DV-XX	•		•	
LUTRON GRAFIX EYE QS: QSGRJ-XP	•		•	
LUTRON RADIO RA2: RRD-10ND	•		•	
LEVITON: LEV40050	•		•	
LEVITON IP710-LFZ	•		•	
LEGRAND: ADPD4FBL3P2W4	•		•	

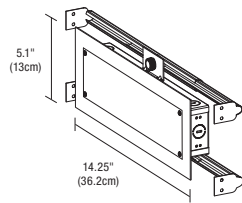

5.1 x 14.25 inch In-Wall Mounting Kit: Includes power supply, box cover and stud hangers for installing Junction Box in wall. Select "IW" in the options section of compatible power supply ordering codes if an In-Wall Mounting Kit is needed.

Ordering Codes: PSB-25W-010-24VDC-IW, PSB-60W-010-24VDC-IW, PSB-96W-010-24VDC-IW

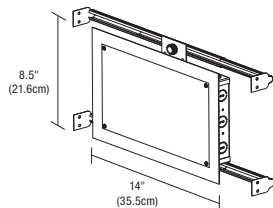

8.5 x 14 inch In-Wall Mounting Kit: Includes power supply, box cover and stud hangers for installing Junction Box in wall. Select "IW" in the options section of compatible power supply ordering codes if an In-Wall Mounting Kit is needed.

Ordering Codes: PSB-2X96W-010-24VDC-IW

PROJECT		FIXTURE TYPE		DATE	
---------	--	--------------	--	------	--

SAMPLE WIRING DIAGRAMS 24VDC 010

Application: 0-10V Dimming Applications For Static White and Dynamic Tunable White 0-10V Dual Dimming.

Dimming: Dimmable with 0-10V dimmers: Signify (Phillips) Sunrise: SR1200ZTUNV, Leviton Dimmers: LEV40050, IP710-LFZ, *IP710-DLZ *(Built in LED locator light) Legrand Dimmer: ADPD4FBL3P2W4 Lutron Systems: Lutron GRAFIX Eye QS Main Unit (with DRX-TVI) Radio Ra2 (with GRX-TVI)

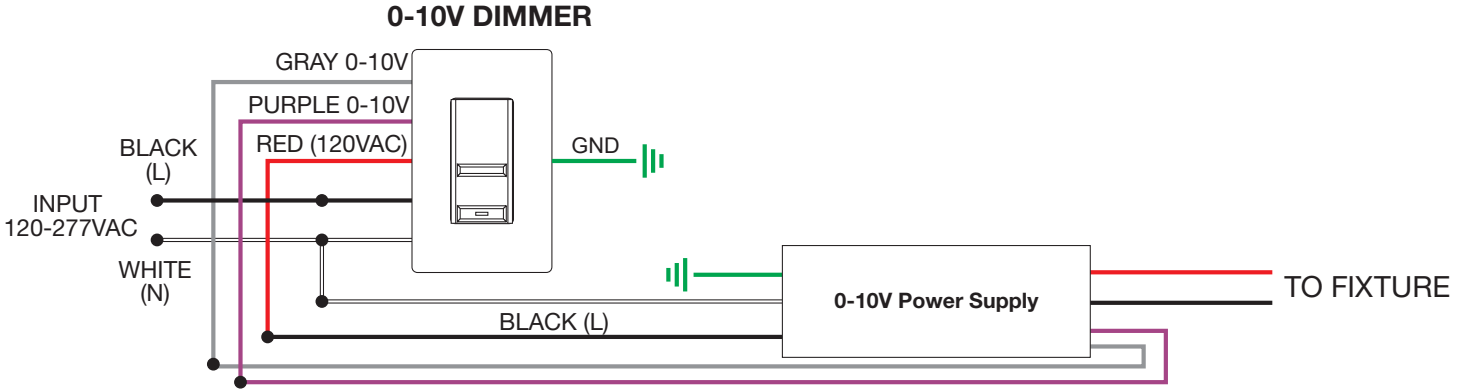

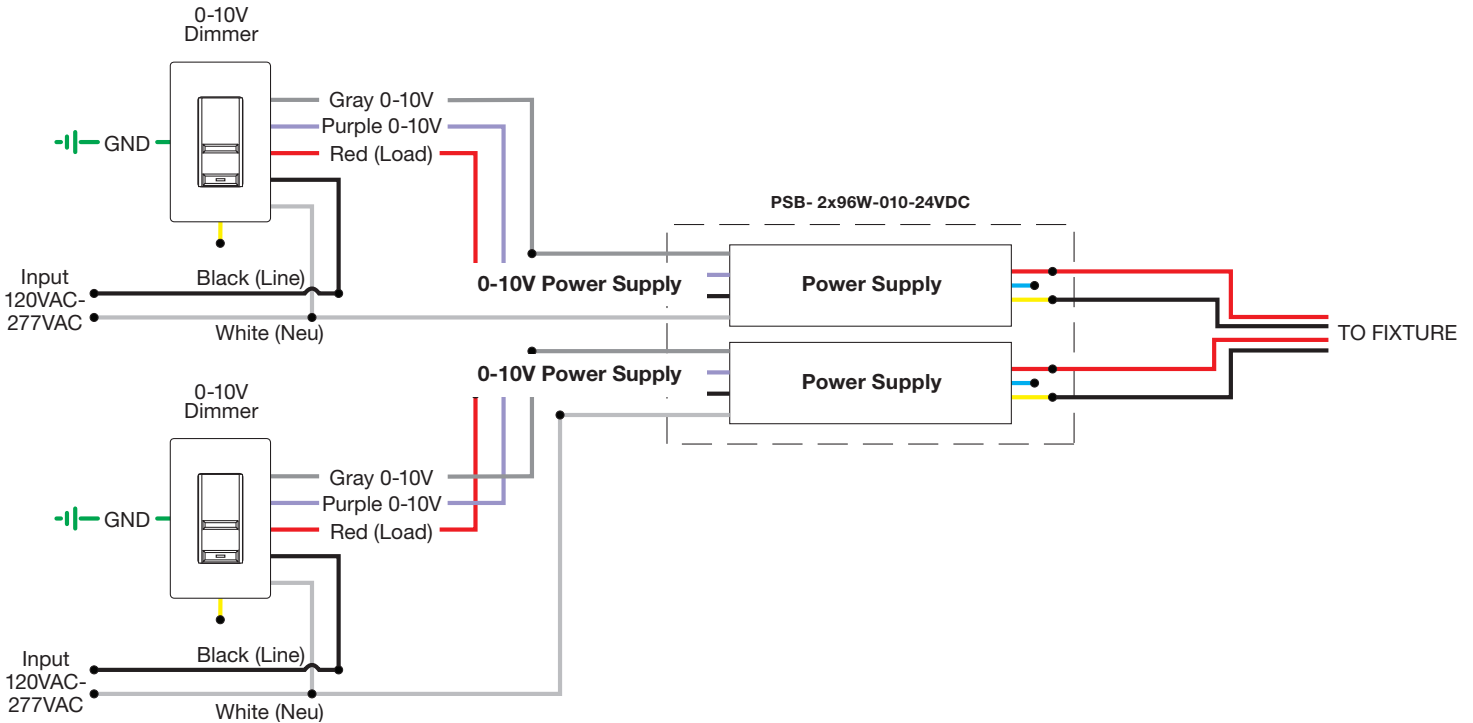

Application: Dual 0-10V dimming for Dynamic/Tunable White 2000K-4000K

Dimming: Dimmable with Dual 0-10V dimmers: Signify (Phillips) Sunrise: SR1200ZTUNV, Leviton Dimmers: LEV40050, IP710-LFZ, *IP710-DLZ *(Built in LED locator light), Legrand Dimmer: ADPD4FBL3P2W4, Lutron Systems: Lutron GRAFIX Eye QS Main Unit (with DRX-TVI) Radio Ra2 (with GRX-TVI)



PROJECT	FIXTURE TYPE	DATE
---------	--------------	------

LUTRON HI-LUME® PREMIER .1% ECOSYSTEM®†			
ORDERING CODES	L3D0-96W24V-U	2-WIRE ECOSYSTEM LTEA4U1UKL-CV240	3-WIRE ECOSYSTEM L3DA4U1UKL-CV240
			
SPECIFICATIONS			
MAXIMUM LOAD	96W	5W-40W	5W-40W
INPUT VOLTAGE	120-277VAC	120-277VAC	120-277VAC
OUTPUT VOLTAGE	24VDC	24VDC	24VDC
DIMENSIONS	10.5" X 5.5" X 2"	4" X 4.89" X 2.62"	4" X 4.89" X 2.62"
CLASSIFICATION	CLASS 2	CLASS 2	CLASS 2
DIMMING AND CONTROLS			
RADIO RA2	•	•	•
HOMEWORKS QS	•	•	•
PHPM-3F-120	•	•	•
PHPM-3F-DV	•	•	•
BCI-0-10	•	•	•

†24K - 57K color temperatures are compatible with 0-10V, ELV, and Lutron Hi-lume® Power Supplies. Warm Dim (27D, 30D) color temperatures are only compatible with ELV power supplies.

2-Wire EcoSystem Wiring Diagram

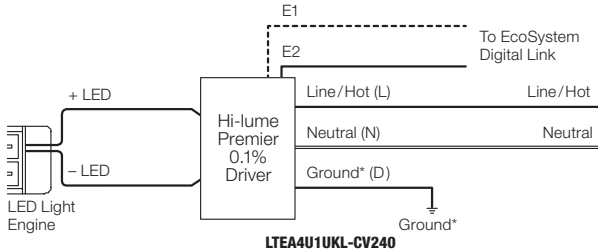

3-Wire Wiring Diagram

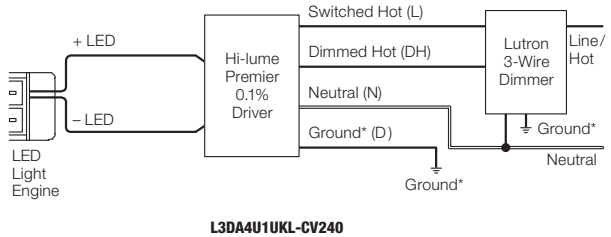

24VDC, DALI

REQUIRED COMPONENTS 24VDC DMX RGB Compatible Power Supplies

DALI DYNAMIC COLOR CHANGING (DMX) POWER SUPPLIES & RECOMMENDED CONTROLLERS†	
ORDERING CODE	PSB-100W-24VDC-DALI
	
SPECIFICATIONS	
MAXIMUM LOAD	100W
INPUT VOLTAGE	120-277VAC
OUTPUT VOLTAGE	24VDC
DIMENSIONS	12.14" X 6.48" X 2.18"
CLASSIFICATION	CLASS 2
IN-WALL MOUNTING	PSB-100W-24VDC-DALI-IW
DIMMING & CONTROLS	
TOUCH SCREEN CONTROLLER (CTP)	•
DMX 1 ZONE RGBW TOUCH CONTROLLER (CDMX1-RGBW)	•
DALI COMPATIBLE	•

†2400K-5700K Color Temperatures are compatible with 0-10V, ELV, and Lutron Hi-lume® Power Supplies. Warm Dim (27D, 30D) Color Temperatures are only compatible with ELV Power Supplies. Tunable White (2K4K) Color Temperature is compatible with 0-10V, ELV, DMX, and Lutron Hi-lume® Power Supplies. Dynamic Color (RGB, RGB+W) and Static Color (Amber, Blue, Green, or Red) are compatible with DMX Power Supplies.

Classification: UL2108 - * 24VDC over 100 Watts, wires must be in conduit from Remote Power Supply to J-box.

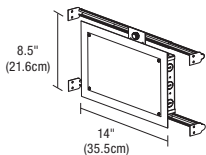

8.5" X 14" IN-WALL MOUNTING KIT

Includes Power Supply, Box Cover, and Stud Hangers for installing Junction Box in wall. Select "IW" in the options section of compatible Power Supply ordering codes if an In-Wall Mounting Kit is needed.

ORDERING CODES: PSB-100W-24VDC-DALI-IW, PSB-100W-24VDC-RGB-IW

PROJECT	FIXTURE TYPE	DATE
---------	--------------	------

SUSPENSION TM30 DATA

STATIC WHITE AND WARM DIM TECHNOLOGY

TM-30-15 DATA: The data below is for SS5C bare LED Soft Strips. Consistent color temperatures throughout a single strip and among multiple strips is possible through a 3 phase binning process in which each order is inspected with a color meter to ensure uniformity.

2200K | Rf: 83.9 | Rg: 94.9

Color Vector Graphic

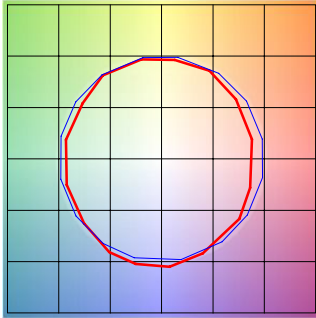

■ Test ■ Reference

GRAPHIC SHIFTS %			
HUE BIN	Rf	CHROMA	HUE
1	77.6	-10.0%	1.8%
2	80.7	-7.5%	7.0%
3	79.5	-2.9%	8.9%
4	90.5	-3.1%	2.4%
5	93.9	-1.3%	1.9%
6	91.9	-0.9%	-0.2%
7	87.6	-6.3%	-2.7%
8	90.5	-5.4%	2.7%
9	83.8	-4.7%	6.5%
10	81.2	-2.5%	10.0%
11	83.3	3.9%	9.4%
12	86.4	5.6%	2.6%
13	86.2	4.5%	-12.4%
14	64.3	-1.0%	-21.9%
15	85.1	-4.4%	-7.5%
16	75.0	-9.9%	-12.0%

2700K | Rf: 87.7 | Rg: 96.1

Color Vector Graphic

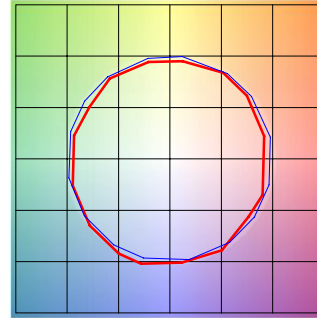

■ Test ■ Reference

GRAPHIC SHIFTS %			
HUE BIN	Rf	CHROMA	HUE
1	86.4	-5.6%	2.3%
2	89.7	-3.3%	3.1%
3	90.5	-1.5%	3.8%
4	90.0	-4.3%	1.1%
5	92.9	-3.7%	0.2%
6	93.5	-2.5%	-0.8%
7	86.3	-7.2%	2.5%
8	90.7	-4.0%	3.2%
9	85.2	-2.4%	8.1%
10	81.7	0.9%	10.8%
11	85.4	4.5%	8.9%
12	88.7	5.7%	-1.4%
13	88.3	1.3%	-7.9%
14	85.1	2.4%	-10.4%
15	88.1	-4.8%	-2.7%
16	81.7	-4.3%	-10.9%

3000K | Rf: 88.1 | Rg: 99.7

Color Vector Graphic

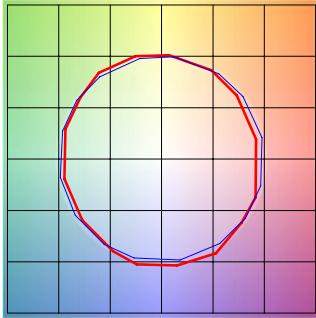

■ Test ■ Reference

GRAPHIC SHIFTS %			
HUE BIN	Rf	CHROMA	HUE
1	87.7	-5.9%	-0.3%
2	87.9	-4.4%	4.3%
3	82.9	-1.2%	7.9%
4	89.9	0.6%	4.7%
5	92.7	3.0%	3.5%
6	92.7	3.6%	-1.7%
7	90.8	-1.3%	-4.4%
8	93.7	-2.5%	-2.2%
9	91.7	-3.7%	2.3%
10	85.5	-2.8%	7.8%
11	83.3	0.7%	11.0%
12	86.4	5.5%	3.8%
13	90.6	4.6%	-3.6%
14	85.6	5.9%	-8.4%
15	89.5	-0.6%	-5.7%
16	82.6	-2.7%	-12.0%

3500K | Rf: 86.1 | Rg: 95.5

Color Vector Graphic

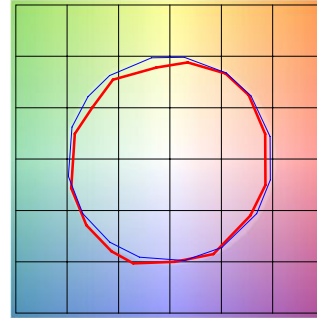

■ Test ■ Reference

GRAPHIC SHIFTS %			
HUE BIN	Rf	CHROMA	HUE
1	91.7	-1.4%	1.8%
2	94.9	-0.7%	0.4%
3	87.9	-4.5%	-4.1%
4	85.9	-10.3%	-2.7%
5	89.8	-5.2%	-0.4%
6	79.6	-9.5%	6.5%
7	87.6	-4.0%	5.7%
8	81.4	-0.5%	11.8%
9	78.3	3.3%	11.4%
10	85.7	6.3%	6.1%
11	86.3	7.1%	-4.6%
12	86.1	-0.7%	-9.6%
13	85.1	0.8%	-10.4%
14	83.4	-4.1%	-5.3%
15	82.5	-3.6%	-5.7%
16	82.5	-3.6%	-5.7%

4000K | Rf: 87.6 | Rg: 96.8

Color Vector Graphic

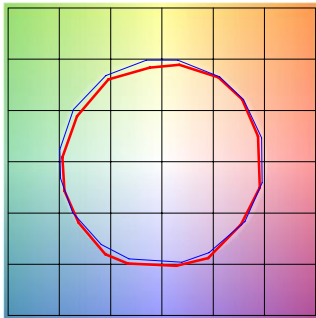

■ Test ■ Reference

GRAPHIC SHIFTS %			
HUE BIN	Rf	CHROMA	HUE
1	89.0	-3.1%	2.1%
2	93.2	-0.9%	1.3%
3	94.3	-1.1%	0.7%
4	89.5	-4.0%	-2.3%
5	87.6	-7.8%	-1.8%
6	92.2	-4.6%	0.1%
7	87.4	-6.6%	3.6%
8	85.7	-3.8%	7.0%
9	81.5	-1.3%	12.4%
10	80.0	0.9%	11.4%
11	83.3	5.9%	8.7%
12	89.7	4.8%	-0.3%
13	88.5	2.4%	-6.3%
14	92.7	4.0%	-3.8%
15	86.1	-1.6%	-4.5%
16	85.0	-1.4%	-5.0%

5700K | Rf: 80.3 | Rg: 91.5

Color Vector Graphic

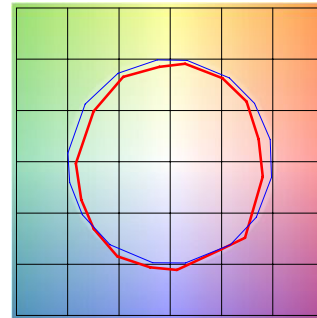

■ Test ■ Reference

GRAPHIC SHIFTS %			
HUE BIN	Rf	CHROMA	HUE
1	73.8	-11.2%	2.6%
2	83.7	-5.5%	5.8%
3	84.2	-4.0%	5.5%
4	85.8	-3.5%	1.3%
5	85.3	-7.1%	0.6%
6	89.2	-5.8%	-2.2%
7	81.5	-10.7%	1.2%
8	75.7	-9.7%	8.5%
9	74.9	-7.8%	18.8%
10	67.8	-1.6%	18.0%
11	76.1	5.5%	12.0%
12	90.8	4.9%	-1.6%
13	83.6	5.0%	-9.5%
14	81.7	-1.2%	-10.0%
15	69.0	2.0%	-22.8%
16	83.2	-8.5%	-1.0%

PROJECT	FIXTURE TYPE	DATE
---------	--------------	------

SUSPENSION TM30 DATA

STATIC WHITE AND WARM DIM TECHNOLOGY

TM-30-15 DATA: The data below is for SS5C bare LED Soft Strips. Consistent color temperatures throughout a single strip and among multiple strips is possible through a 3 phase binning process in which each order is inspected with a color meter to ensure uniformity.

2700D | Rf: 89.5 | Rg: 100.8

Color Vector Graphic

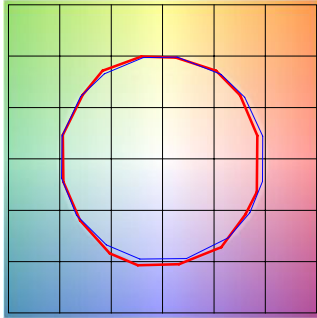

■ Test ■ Reference

GRAPHIC SHIFTS %			
HUE BIN	Rf	CHROMA	HUE
1	88.8	-5.1%	1.4%
2	89.8	-2.7%	4.1%
3	87.2	0.3%	5.9%
4	92.3	-0.9%	1.0%
5	93.3	1.5%	1.7%
6	92.4	3.6%	-0.2%
7	92.2	-0.9%	-2.4%
8	96.7	-0.4%	-1.1%
9	92.3	-1.2%	3.7%
10	88.9	-0.0%	6.1%
11	86.4	5.1%	7.4%
12	88.2	6.3%	-0.9%
13	87.2	3.8%	-8.1%
14	84.2	3.8%	-11.0%
15	89.8	-2.6%	-4.3%
16	82.7	-3.4%	-11.1%

3000D | Rf: 89.8 | Rg: 101.4

Color Vector Graphic

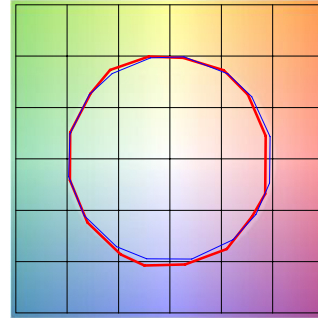

■ Test ■ Reference

GRAPHIC SHIFTS %			
HUE BIN	Rf	CHROMA	HUE
1	90.2	-4.2%	1.5%
2	90.9	-2.0%	3.7%
3	87.9	0.8%	5.5%
4	92.1	-0.9%	0.6%
5	93.0	1.5%	1.6%
6	92.2	3.9%	-0.2%
7	92.1	-0.3%	-2.0%
8	96.7	0.0%	-1.2%
9	92.5	-0.6%	3.7%
10	88.3	1.1%	7.0%
11	87.2	4.1%	7.4%
12	87.2	6.7%	-1.0%
13	88.2	3.8%	-7.2%
14	85.3	4.3%	-9.9%
15	90.9	-2.2%	-3.6%
16	83.4	-2.2%	-11.2%

PROJECT	FIXTURE TYPE	DATE
---------	--------------	------