



# MONORAIL

## 12VAC, SYSTEM & COMPONENTS



DESIGNED BY GREGORY KAY

REV 02.14.22

### STRAIGHT RAIL

#### DESCRIPTION

Straight Rail, Monorail System Conductor, in 24" (61cm), 48" (122cm) or 96" (243.8cm) lengths is field cuttable and hand-bendable. Rated for maximum of 25 amps (300 watts at 12 volts, 600 watts at 24 volts). Monorail has a max run length of 30' in any direction. Pair of Conductive Connectors included with each section to connect to other Rail sections. Clear Insulator.



SATIN NICKEL

#### LABELS

Assembled in America



#### STANDOFFS

- 12: 2
- 24: 2
- 36: 2
- 48: 3
- 60: 3

#### WEIGHT

- 24": 0.3 lbs. (0.13 kg)
- 48": 0.6 lbs. (0.27 kg)
- 96": 1.2 lbs. (0.54 kg)

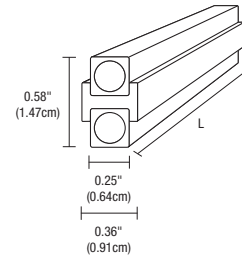

#### FINISHES



Antique Bronze  
**BZ**



Satin Nickel  
**SN**

| System            | Length   | Finish   |
|-------------------|--|--|
| <b>M</b>          | <b>24</b>  | <b>BZ</b>  |
| <b>M</b> Monorail | <b>24</b> 24" (61cm)<br><b>48</b> 48" (122cm)<br><b>96</b> 96" (243.8cm) | <b>BZ</b> Antique Bronze<br><b>SN</b> Satin Nickel |

#### 90° CURVE

Pre-Bent 90° Curve in 12" (30.5cm), 24" (61cm), 36" (91.4cm), 48" (122cm) or 60" (152.4cm) radius options offer versatility for numerous applications. Rated for maximum of 25 amps (300 watts at 12 volts, 600 watts at 24 volts). A pair of Conductive Connectors is included with each piece to connect other Monorail sections. Clear Insulator.

| System            | Radius (R)   | Finish                 |
|-------------------|--|------------------------|
| <b>M</b>          | <b>12R</b>   | <b>SN</b>              |
| <b>M</b> Monorail | <b>12R</b> 12" (30.5cm) Radius<br><b>24R</b> 24" (61cm) Radius<br><b>36R</b> 36" (91.4cm) Radius<br><b>48R</b> 48" (122cm) Radius<br><b>60R</b> 60" (152.4cm) Radius | <b>SN</b> Satin Nickel |

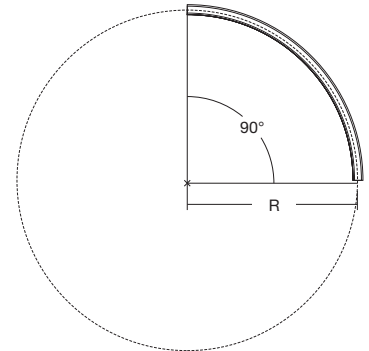

### PRE-BENT MONORAIL

#### CIRCLE

Pre-Bent Circle features clean simple shapes for versatile applications. Rated for maximum of 25 amps (300 watts at 12 volts, 600 watts at 24 volts). Pair of Conductive and Isolating Connectors included. Clear Insulator.

| System            | Diameter (D)  | Finish                 |
|-------------------|---|------------------------|
| <b>M</b>          | <b>12R</b>  | <b>SN</b>              |
| <b>M</b> Monorail | <b>24C</b> 24" (61cm) Circle<br><b>36C</b> 36" (91.4cm) Circle<br><b>48C</b> 48" (122cm) Circle<br><b>60C</b> 60" (152.4cm) Circle<br><b>72C</b> 72" (182.9cm) Circle<br><b>84C</b> 84" (213.4cm) Circle<br><b>96C</b> 96" (243.8cm) Circle<br><b>108C</b> 108" (274.3cm) Circle<br><b>120C</b> 120" (304.8cm) Circle | <b>SN</b> Satin Nickel |

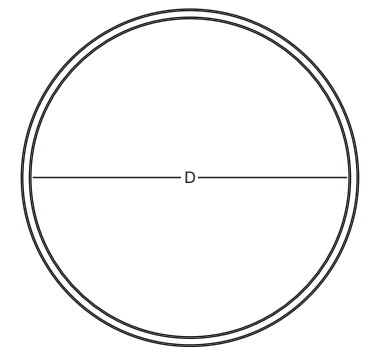

#### S-CURVE

Pre-Bent S-Curve with 60° radius and 92" (234cm) linear length features a distinct design ideal for numerous applications. Rated for maximum of 25 amps (300 watts at 12 volts, 600 watts at 24 volts). Includes a pair of Conductive Connectors and two pairs of End Caps. Clear Insulator.

| System            | Length                         | Finish                 |
|-------------------|--------------------------------|------------------------|
| <b>M</b>          | <b>92S</b>                     | <b>SN</b>              |
| <b>M</b> Monorail | <b>92S</b> 92" (234cm) S-Curve | <b>SN</b> Satin Nickel |

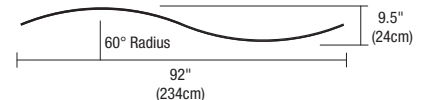

|         |              |      |
|---------|--------------|------|
| PROJECT | FIXTURE TYPE | DATE |
|---------|--------------|------|

# STANDOFFS

REV 02.14.22

## MONORAIL FAST JACK FIXTURE CONNECTOR

The Monorail Fast Jack Fixture Connector attaches any Fast Jack head or pendant to Monorail.

**WEIGHT**  
.10 lb (.045 kg)

| System                       | Type                | Finish   |
|------------------------------|---------------------|--|
| <b>MC</b>                    | <b>FJ</b>           | <b>BZ</b>  |
| <b>MC</b> Monorail Connector | <b>FJ</b> Fast Jack | <b>BZ</b> Antique Bronze<br><b>SN</b> Satin Nickel |

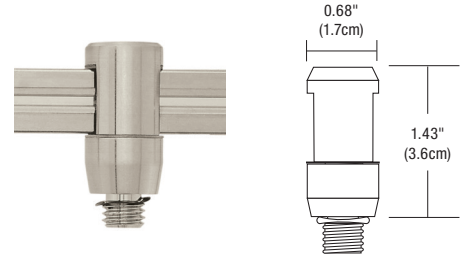

## 1" RIGID STANDOFF

The 1" (2.5cm) Rigid Standoff is compatible with all standard power feed canopies and surface mount transformers. Use standoffs approximately every 3' (91cm) of Monorail run. For the best appearance, place standoffs near the rail end and at the point where two rails connect. Use rigid standoffs for curved runs or runs with heavier fixtures.

**WEIGHT**  
.20 lb (.09 kg)

| System                      | Height              | Finish   |
|-----------------------------|---------------------|--|
| <b>MS</b>                   | <b>1</b>            | <b>BZ</b>  |
| <b>MS</b> Monorail Standoff | <b>1</b> 1" (2.5cm) | <b>BZ</b> Antique Bronze<br><b>SN</b> Satin Nickel |



## RIGID STANDOFF

Rigid standoffs are available in heights of 4" (10.2cm), 6" (15.2cm), 12" (31cm), 24" (61cm), 36" (91cm), 48" (122cm). Standoffs are field-cuttable and best suited for curved runs or runs with heavier fixtures. For the best appearance, place standoffs near the rail end and at the point where two rails connect.

**WEIGHT**  
.20 - 1 lb (.09 - .45 kg)

| System                      | Height                 | Finish                 |  |
|-----------------------------|------------------------|------------------------|--|
| <b>MS</b>                   | <b>12</b>              | <b>BZ</b>              |  |
| <b>MS</b> Monorail Standoff | <b>4</b> 4" (10.2cm)   | <b>24</b> 24" (61cm)   | <b>BZ</b> Antique Bronze<br><b>SN</b> Satin Nickel |
|                             | <b>6</b> 6" (15.2cm)   | <b>36</b> 36" (91.4cm) |  |
|                             | <b>12</b> 12" (30.5cm) | <b>48</b> 48" (122cm)  |  |

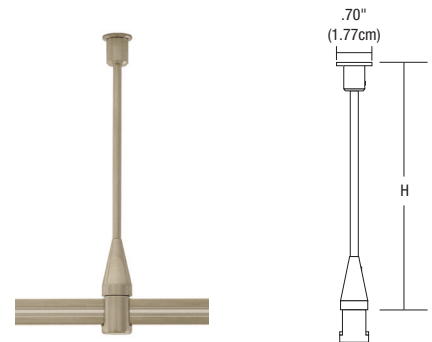

## ADJUSTABLE STANDOFF

The Adjustable Standoff provides a clean and minimal look. An integral wire grip adjusts and locks the 12' (3.65m) field-cuttable aircraft cable in place. Best suited for straighter runs. Use a standoff every 3' (91.4cm) of rail. For best appearance, place a standoff at every point where two pieces of Monorail connect.

**WEIGHT**  
.35 lb (.16 kg)

| System                      | Height              | Finish                 |
|-----------------------------|---------------------|------------------------|
| <b>MS</b>                   | <b>A</b>            | <b>SN</b>              |
| <b>MS</b> Monorail Standoff | <b>A</b> Adjustable | <b>SN</b> Satin Nickel |

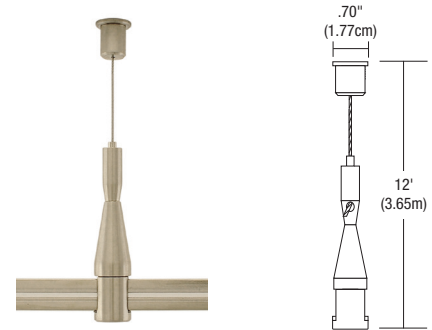

## SLOPED CEILING ADJUSTABLE STANDOFF

The Sloped Ceiling Adjustable Standoff provides a clean and minimal look. An integral wire grip adjusts and locks the 12' field-cuttable aircraft cable in place. Use one standoff approximately every 3' of the rail, at corners and joints. Use with sloped ceiling power feed canopies and surface mounted transformers.

**WEIGHT**  
.25 lb (.11 kg)

| System                      | Height                             | Finish   |
|-----------------------------|------------------------------------|--|
| <b>MS</b>                   | <b>SLA</b>                         | <b>BZ</b>  |
| <b>MS</b> Monorail Standoff | <b>SLA</b> 12' (365.8m) Adjustable | <b>BZ</b> Antique Bronze<br><b>SN</b> Satin Nickel |

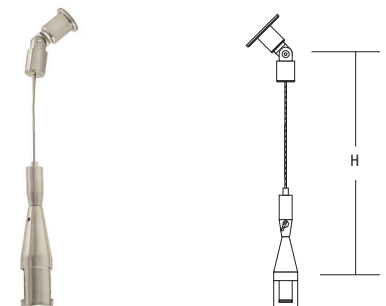

|         |  |              |  |      |  |
|---------|--|--------------|--|------|--|
| PROJECT |  | FIXTURE TYPE |  | DATE |  |
|---------|--|--------------|--|------|--|



# POWER FEED CANOPIES

## MONORAIL

### MONORAIL 4" ROUND SINGLE FEED POWER CANOPY

Monorail 4" Round Single Feed Power Canopy powers the rail 1" (2.5cm) from the ceiling and mounts to a standard 4" electrical box with plaster ring or an octagon box. Use with 1" Rigid Standoff and remote transformer: 12 volt - 60, 150, 175 or 300 watt; 24 volt - 300 or 600 watt. Satin Nickel finish.

**WEIGHT:**

.95 lb (.43 kg)

| System                 | Canopy                  | Height       | Finish          |
|------------------------|-------------------------|--------------|-----------------|
| <b>MP</b>              | <b>4RD</b>              | <b>1</b>     | <b>SN</b>       |
| MP Monorail Power Feed | 4RD 4.3" (10.9cm) Round | 1 1" (2.5cm) | SN Satin Nickel |

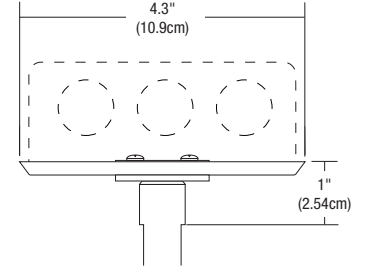

### 4" ROUND ADJUSTABLE CENTER FEED CANOPIES

The Adjustable Center Feed Canopy mounts to a standard 4" electrical box with a plaster ring or an octagon box. Available in single or dual feed, the adjustable 12' (3.65m) cable powers any where of the rail where an electrical box cannot be located directly above the system. Use in conjunction with corresponding remote transformers. Satin Nickel finish.

**WEIGHT**

Single Feed 2lb (.9 kg)  
Dual Feed 4lb (1.8 kg)

| System  | Canopy                  | Height                   | Finish          |
|---|-------------------------|--------------------------|-----------------|
| <b>MP</b>   | <b>4RD</b>              | <b>A</b>                 | <b>SN</b>       |
| MP Monorail Power Feed<br>MPD Monorail Power Dual Feed* | 4RD 4.3" (10.9cm) Round | A Adjustable Center Feed | SN Satin Nickel |

\*Limited Quantities, please call for availability.

MP-4RD-A-SN

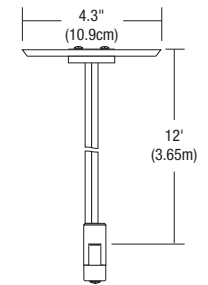

MPD-4RD-A-SN

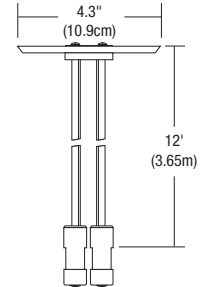

### DROP CEILING T-BAR CLIP

The T-Bar clip is used for mounting rigid or adjustable Monorail/Monorail 2 Circuit standoffs to T-Bar grid ceilings. Clips fit on both 9/16" and 15/16" drop ceiling grids. Use one for each standoff. White finish.

**WEIGHT**

.05 lb (.022 kg)

| System               | Type                 | Finish   |
|----------------------|----------------------|----------|
| <b>MS</b>            | <b>TBAR</b>          | <b>W</b> |
| MS Monorail Standoff | TBAR 9/16" or 15/16" | W White  |

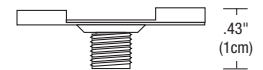
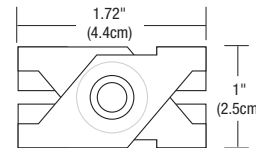

|         |  |              |  |      |  |
|---------|--|--------------|--|------|--|
| PROJECT |  | FIXTURE TYPE |  | DATE |  |
|---------|--|--------------|--|------|--|



**STRAIGHT ISOLATING CONNECTORS**

A pair of translucent straight isolating connectors physically joins and electrically isolates two Monorail sections. All dual power feed canopies include a pair of isolating connectors.

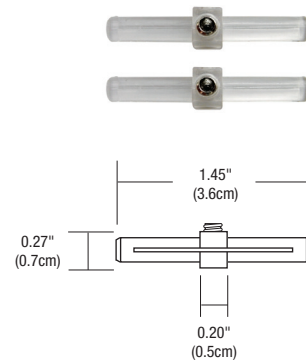
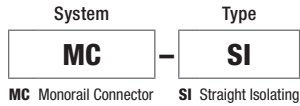

**STRAIGHT CONDUCTIVE CONNECTORS**

A pair of straight conductive connectors physically and electrically joins two Monorail sections. Each piece of Monorail includes one pair. Additional pairs are required when rail is cut and rejoined.

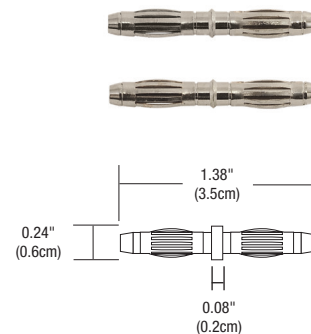
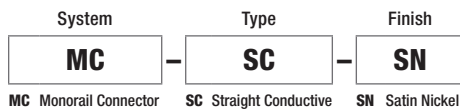

**END CAPS**

A pair of End Caps pushes into the ends of Monorail runs for a clean finished look. One pair is required for each end.

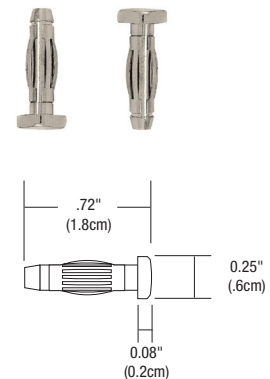
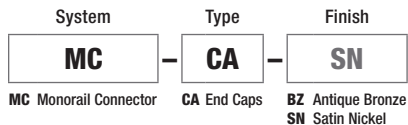

**ADJUSTABLE END CONNECTOR**

The Adjustable End Connector electrically connects a surface mount transformer to a rail end or two sections of Monorail end-to-end. It is comprised of two Monorail end connectors joined with 36" (91cm) of clear adjustable cable.

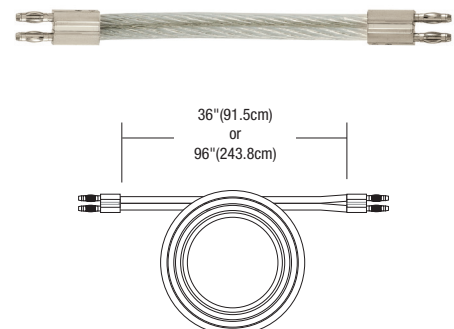
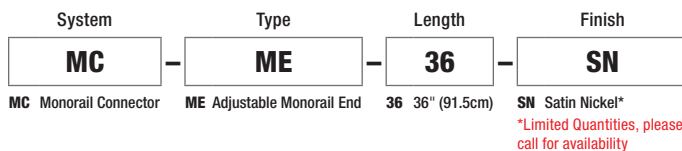

|         |  |              |  |      |  |
|---------|--|--------------|--|------|--|
| PROJECT |  | FIXTURE TYPE |  | DATE |  |
|---------|--|--------------|--|------|--|



**L-CEILING CONDUCTIVE CONNECTOR**

The L-Ceiling Conductive Connector physically and electrically joins two Monorail sections at 90° on a horizontal plane. Satin Nickel finish.

| System                | Type         | Finish          |
|-----------------------|--------------|-----------------|
| <b>MC</b>             | <b>LC</b>    | <b>SN</b>       |
| MC Monorail Connector | LC L-Ceiling | SN Satin Nickel |

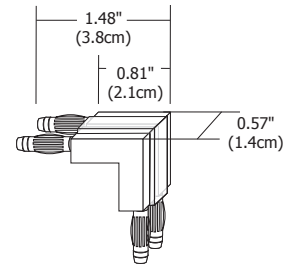
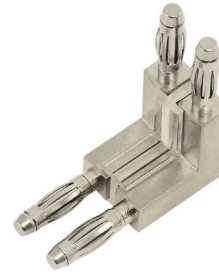

**FLEXIBLE CONDUCTIVE CONNECTOR**

A pair of Flexible Conductive Connectors physically and electrically joins two Monorail sections at any angle from 45° to 180° on a horizontal plane.

| System                | Type        | Finish            |
|-----------------------|-------------|-------------------|
| <b>MC</b>             | <b>FX</b>   | <b>BZ</b>         |
| MC Monorail Connector | FX Flexible | BZ Antique Bronze |

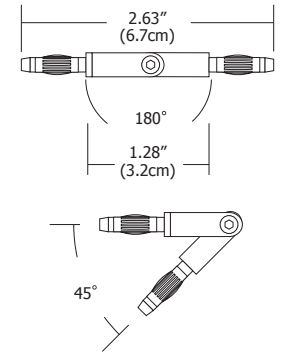

**T-CONDUCTIVE CONNECTOR**

A pair of T-Conductive Connectors physically and electrically joins three Monorail sections at 90° angles. Satin Nickel finish.

| System                | Type            | Finish          |
|-----------------------|-----------------|-----------------|
| <b>MC</b>             | <b>TC</b>       | <b>SN</b>       |
| MC Monorail Connector | TC T-Conductive | SN Satin Nickel |

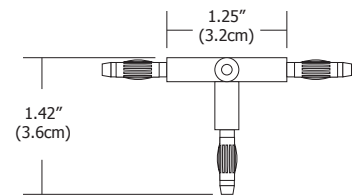

**X-CONDUCTIVE CONNECTOR**

A pair of X-Conductive Connectors physically and electrically joins four Monorail sections at 90° angles. Satin Nickel finish.

| System                | Type            | Finish           |
|-----------------------|-----------------|------------------|
| <b>MC</b>             | <b>XC</b>       | <b>SN</b>        |
| MC Monorail Connector | XC X-Conductive | SN Satin Nickel* |

\*Limited Quantities, please call for availability

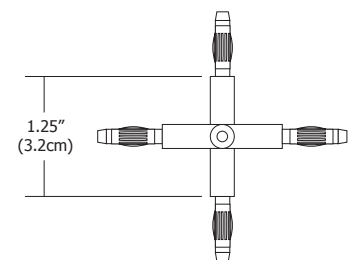

|         |              |      |
|---------|--------------|------|
| PROJECT | FIXTURE TYPE | DATE |
|---------|--------------|------|

# MONORAIL SURFACE MOUNT ELECTRONIC TRANSFORMER

150W/12VAC

## DESCRIPTION

The Surface Mount 150 Watt Electronic Transformer is used on ceilings as an alternative to remote power supply feeds and powers the Monorail from an electrical box within range of the system. The compact, lightweight transformer converts 120 volts to safe-to-touch 12 volt power. The short-circuit protected transformer can be reset at wall switch in the event of a short or overload.

Rail attaches 1" from the ceiling to one or both sides using push-in conductive connectors (included). The transformer powers a total of 150 watts. Use with 1" Rigid Standoffs.

## POWER INPUT

- 120 volts AC

## POWER OUTPUT

- 12 volt AC, 150 Watts

## DIMMER USED

- Electronic Low Voltage Dimmer

## GENERAL REQUIREMENTS

- 1" Standoff is used

## DIMENSIONS

- 8" (Ø) x 2.06" (H)  
(20.3cm x 5.2cm)

## FINISH



Antique Bronze **BZ**     Satin Nickel **SN**

## WEIGHT

- 4 lbs (1.8 kg)

| System   | Power/Voltage Output                     | Finish   |
|--|--|--|
| <b>MTE</b>   | <b>150L-12</b>                           | <b>SN</b>  |
| <small>MTE Monorail Transformer Electronic Surface Mount</small> | <small>150L-12 150 Watt, 12 Volt</small> | <small>BZ Antique Bronze<br/>SN Satin Nickel</small> |



**MTE-150L-12-SN**

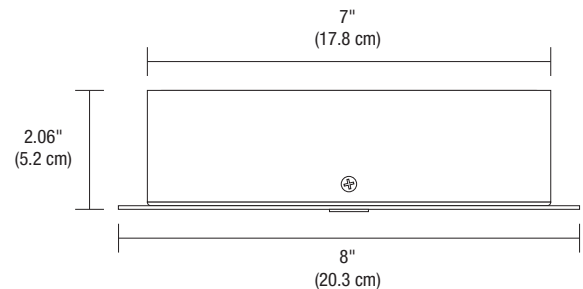

# MONORAIL CANOPY MOUNT LED TRANSFORMER

## MONORAIL CANOPY MOUNT LED 60W/12V ELECTRONIC TRANSFORMER

The electronic 60 watt 12 volt transformer, features fast acting circuit breaker on low voltage side of transformer. which will shut the system off in case of overload or short and can be easily reset. Satin Nickel finish.

## DIMMING

Dimmable with low voltage electronic dimmer

## STANDARD MOUNTING

Rail mounts 1" (2.5cm) from ceiling

## FINISH

Satin Nickel

| Transformer Type  | Wattage                        | Voltage Output                        | Finish                         |
|---|--------------------------------|---------------------------------------|--------------------------------|
| <b>MTE</b>  | <b>60L</b>                     | <b>12</b>                             | <b>SN</b>                      |
| <small>MTE Monorail Canopy Mount Electronic Transformer</small> | <small>60L 60 Watt LED</small> | <small>12 12 Volt Single Feed</small> | <small>SN Satin Nickel</small> |

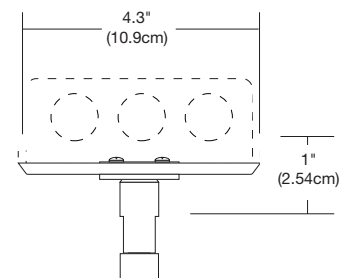

|         |  |              |  |      |  |
|---------|--|--------------|--|------|--|
| PROJECT |  | FIXTURE TYPE |  | DATE |  |
|---------|--|--------------|--|------|--|



# 300W/12V MAGNETIC REMOTE MOUNT TRANSFORMER

## TRANSFORMER



REV 02.14.22

### DESCRIPTION

The 300 watt 12 volt magnetic remote mount transformer converts line voltage into 12 volt power and are protected by fast-acting circuit breakers. The safe-to-touch low voltage output powers Monorail systems up to 300 watts using 12 volt lamps. All 12 volt remote magnetic transformers are LED compatible with 12 volt AC LEDs.

### POWER INPUT

120 volts AC 2.5 Amp  
230 volt AC 1.3 Amp  
277 volt AC 1.1 Amp

### POWER OUTPUT

12 volts AC 300 watt 25 Amp

### INSTALLATION

Remote magnetic transformers must be installed in an accessible location, such as an attic or in a closet, up to 20' from the power feed canopy. Plug in version available. To avoid overheating the transformer, install it in a ventilated remote location where air flows. Maintain proper spacing among transformers when multiple transformers are installed in the same remote location.

### DIMMING

Halogen: 600 Watt Magnetic Low Voltage Dimmer. Compatible dimmers are connected on the line voltage side of transformers. Some buzzing may occur at low levels and may be reduced with a de-buzzing coil. Visit [www.pureedgelighting.com](http://www.pureedgelighting.com) for up-to-date LED dimming information.

### DIMENSIONS

8.75"(L) x 4.4"(D) x 3.8"(H)  
(22.2cm x 11.2cm x 9.7cm)

### WEIGHT

8.41 lb (3.81 kg)



T-300-12

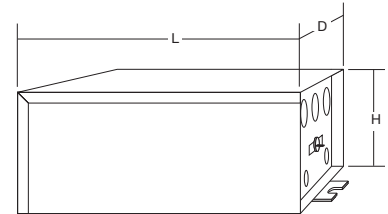

| System               | Power/Voltage Output    | Voltage                       |
|----------------------|-------------------------|-------------------------------|
| <b>T</b>             | <b>300-12</b>           | LEAVE BLANK FOR STANDARD 120V |
| T Remote Transformer | 300-12 300 Watt 12 Volt | 2 230V 50Hz                   |

### LOW VOLTAGE FEED WIRE SIZE CHART

To determine the correct THHN wire sizes for a recommended 3% or less drop in voltage for each circuit based on the specified wattage. Lengths are the distance from the remote transformer to the system power feed connector, or power supply.

| 12 VOLT  | 5 ft.  | 6-15 ft. | 16-20 ft. | 21-40 ft. |
|----------|--------|----------|-----------|-----------|
| 300 watt | #10 GA | #6 GA    | #4 GA     | #1 GA     |

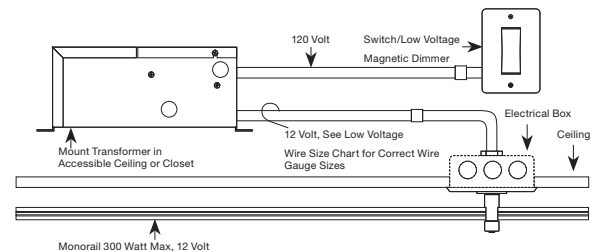

### Compatible Power Feed Canopies

| System                 | Canopy                | Height                        | Finish          |
|------------------------|-----------------------|-------------------------------|-----------------|
| <b>MP</b>              | <b>4RD</b>            | <b>1</b>                      | <b>SN</b>       |
| MP Monorail Power Feed | 4RD 4.3" Round Canopy | 1 1" (2.5cm)                  | SN Satin Nickel |
| System                 | Canopy                | Height                        | Finish          |
| <b>MP</b>              | <b>4RD</b>            | <b>A</b>                      | <b>SN</b>       |
| MP Monorail Power Feed | 4RD 4.3" Round Canopy | A 12' (3.7m) Adjustable Cable | SN Satin Nickel |

|         |  |              |  |      |  |
|---------|--|--------------|--|------|--|
| PROJECT |  | FIXTURE TYPE |  | DATE |  |
|---------|--|--------------|--|------|--|

# PSB-60W-12VDC

## POWER SUPPLY

### DESCRIPTION

LED power supplies transform and regulate power from a line voltage power source into low voltage power for use with LED lighting. The PSB-60W-12VDC power supply accepts input voltage ranging from 100-240 volts AC and outputs 12 volt DC power up to 60 watts  
 \*Electrical Panels using Seimens/Murray AFCI breakers are not compatible with this ELV transformer. Use 0-10 Volt power supplies with this breaker.  
 \*\*ELV power supplies are not compatible with nLight, use only 0-10 volt or Uni driver power supplies

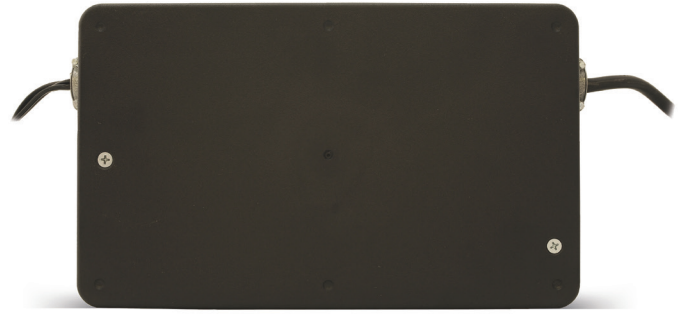

### APPLICATIONS

Indoor or Outdoor

### POWER INPUT

100-240VAC, 50/60Hz

### POWER OUTPUT

12 volts DC 5A, 60 watts maximum

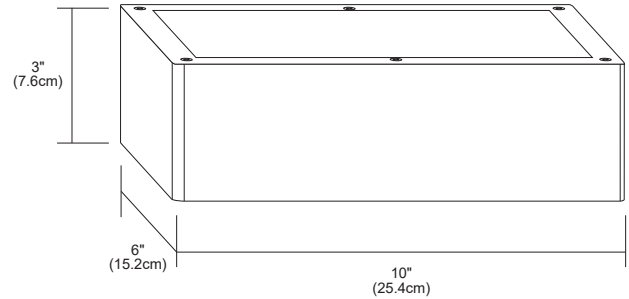

### DIMENSIONS

10" x 6" x 3"



| Product  | Wattage                     | Voltage                         |
|--|-----------------------------|---------------------------------|
| <b>PSB</b>   | <b>60W</b>                  | <b>12VDC</b>                    |
| <small>PSB Power Supply with Enclosure Box</small> | <small>60W 60 Watts</small> | <small>12VDC 12 Volt DC</small> |

### Compatible Power Feed Canopies

|  | System                                | Canopy                               | Height                                       | Finish                         |
|--|---------------------------------------|--------------------------------------|--|--------------------------------|
|   | <b>MP</b>                             | <b>4RD</b>                           | <b>1</b>                                     | <b>SN</b>                      |
|  | <small>MP Monorail Power Feed</small> | <small>4RD 4.3" Round Canopy</small> | <small>1 1" (2.5cm)</small>                  | <small>SN Satin Nickel</small> |
|  | <b>MP</b>                             | <b>4RD</b>                           | <b>A</b>                                     | <b>SN</b>                      |
|  | <small>MP Monorail Power Feed</small> | <small>4RD 4.3" Round Canopy</small> | <small>A 12' (3.7m) Adjustable Cable</small> | <small>SN Satin Nickel</small> |

|         |  |              |  |      |  |
|---------|--|--------------|--|------|--|
| PROJECT |  | FIXTURE TYPE |  | DATE |  |
|---------|--|--------------|--|------|--|