

**PAVO Outdoor**  
**3-753-15**

oxygen

FIXTURE TYPE \_\_\_\_\_

LOCATION \_\_\_\_\_

PROJECT \_\_\_\_\_

DATE \_\_\_\_\_



-15 Black

<b>LIGHT SOURCE</b>	(1x) 8W LED with Driver on board, 3000K, CRI 90
<b>LUMINAIRE POWER</b>	8.3W Input Power
<b>RATED LIFE</b>	30000 hr RL
<b>OPTIONAL COLOR TEMPERATURES</b>	3000K Only
<b>LUMEN OUTPUT</b>	Delivered: 290 lm (LM-79)
<b>INPUT VOLTAGE</b>	120V AC, 50/60Hz
<b>DIMMING</b>	TRIAC Dimming
<b>CONSTRUCTION</b>	Cast Aluminum Housing
<b>DIFFUSER</b>	- Clear Pinstripe Glass
<b>FINISHES</b>	Black (-15)
<b>MOUNTING</b>	4" Octagonal J-Box (Installer must provide a bead of caulk between fixture housing and mounting surface)
<b>STANDARDS</b>	ETL Wet listed, ADA Compliant, Conforms to UL STD 1598, Certified CAN/CSA STD C22.2 No 250.0.

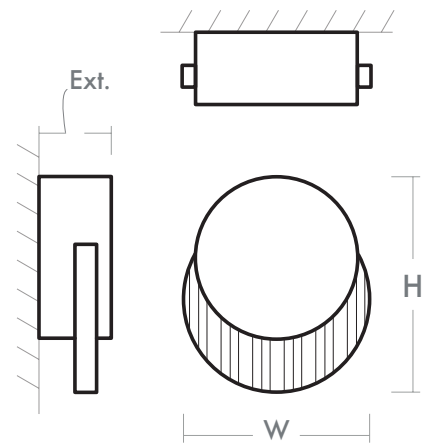

**DIMENSIONS**

<b>W:</b>	<b>5.50"</b>
<b>H:</b>	<b>6.25"</b>
<b>Ext:</b>	<b>2.125"</b>
<b>M.C:</b>	<b>2.375" From top of fixture</b>

Order example for standard fixture:  
**3-753-15** (x- Voltage - xxx-Sequence # - xx-Finish)  
3: 120V Only

