

INSTALLATION INSTRUCTIONS

820 - LED PENDANT

PD-82024 / PD-82027 / PD-82042

MODERN FORMS

CAUTION: To prevent electrical shock, ensure electricity has been turned off at the circuit breaker before beginning.

- Read all instructions before installing.
- System is intended for installation by a licensed electrician in accordance with the National Electrical Code (NEC) and local regulations.
- When handling the fixture, do not apply pressure to the LEDs. Hold the fixture by the base only.
- Retain installation instructions for future maintenance reference.

WARNING: All parts must be used as indicated in these instructions. This product is designed for use only with the supplied parts and/or accessories designated for use by Modern Forms. Substitution of parts or accessories not designated for use with this product by Modern Forms could result in personal injury or property damage, and will void the warranty. Contact an authorized dealer or the manufacturer if any parts are damaged or missing.

MAINTENANCE NOTE: Coastal conditions may cause mineral and residue build-up on the fixture. We recommend that customers in coastal areas clean all external surfaces of the fixture once every two weeks with a wet cloth.

MISE EN GARDE: Pour éviter tout choc électrique, assurez-vous que le disjoncteur soit mis hors tension avant de commencer.

- Lisez toutes les instructions avant l'installation.
- Le système doit être installé par un électricien licencié conformément au code national de l'électricité (NEC), et également aux règlements locaux.
- Lors de la manipulation du luminaire, n'appuyez pas sur les LED. Tenez-le uniquement par la base.

ATTENTION: Toutes les pièces doivent être utilisées comme indiqué dans ces instructions. Ce produit est conçu pour être utilisé seulement avec les pièces et/ou accessoires fournis pour être utilisés avec les produits Modern Forms. Remplacer des pièces ou accessoires non conçus pour ce produit Modern Forms pourrait causer des dommages corporels ou matériels et pourrait également causer l'annulation de la garantie. Veuillez contacter un revendeur autorisé ou le fabricant si des pièces manquent ou sont endommagées.

NOTE D'ENTRETIEN: Les conditions côtières peut causer une accumulation de minéraux et de résidus sur le luminaire. Nous recommandons aux clients qui résident dans les zones côtières de nettoyer toutes les surfaces externes du luminaire une fois toutes les deux semaines avec un chiffon humide.

PICTURE

PD-82024

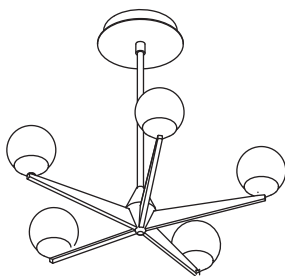

PD-82027

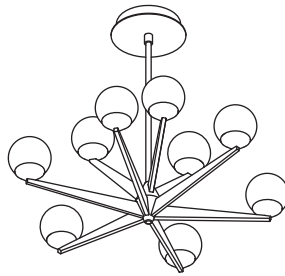

PD-82042

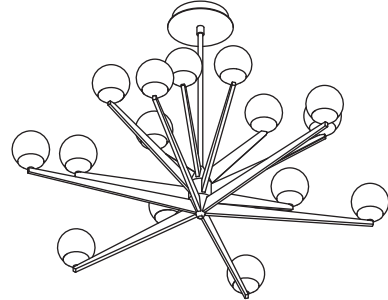

HARDWARE

A

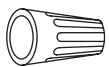

Wire Connector
Qty: 3pcs+1Extra

B



Wire Connector
Qty: 2pcs+1Extra

C



Mounting Screw
Qty: 1 Extra

D



Wood Screw
Qty: 3PCS+1Extra

E



Plastic Anchor
Qty: 3PCS+1 Extra

modernforms.com
Phone (800) 526.2588
Fax (800) 526.2585

Headquarters/Eastern Distribution Center
44 Harbor Park Drive
Port Washington, NY 11050

Central Distribution Center
1600 Distribution Ct
Lithia Springs, GA 30122

Western Distribution Center
1750 Archibald Avenue
Ontario, CA 91760



INSTALLATION INSTRUCTIONS
820 - WALL SCONCE
 PD-82024 / PD-82027 / PD-82042

MODERN FORMS

PREPARATION

1. Shut off the power at the circuit breaker and remove existing fixture, including the crossbar.
2. Carefully unpack your new fixture and lay out all the parts on a clear area. Be careful not to lose any small parts necessary for installation.

MOUNTING THE FIXTURE (Fig. 1)

3. Remove the mounting screw (B) from the fixture, take down the mounting plate.
4. Drill holes in the wall aligned with the key holes located in the mounting plate, insert the plastic anchor(E).
5. Secure the mounting plate to the junction box using standard junction box screws that comes with the junction box. fasten it to the wall using wood screw(D).
 Note: (i) using any other non-original-manufacturer provided junction box screw may result in safety issue;
 (ii) The side of the mounting back plate marked "GND" must face out.
6. Choose the number of the rods suitable for your application. Thread the fixture wire through the rods, swivel and canopy. Connect the fixture, rods and swivel. Make sure all are tightened.
 Note: For PD-82042, hook the safety cord to the mounting plate;

Fig.1

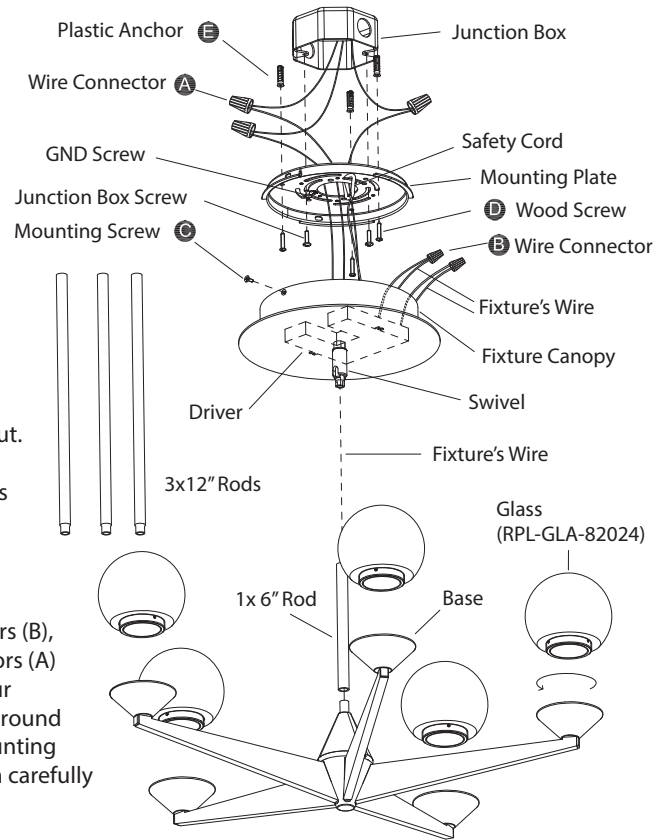

CONNECTING THE WIRES (Fig. 2)

7. Connect the fixture's wires with driver's output wires using wire connectors (B), Connect the driver's input wires to junction box wires using wire connectors (A) as shown in Fig. 2, making sure that all wire connectors are secured. If your outlet box has a green or bare copper ground wire, connect the fixture's ground wire to it. Otherwise, connect the fixture's ground wire directly to the mounting plate using the GND screw provided. After wires are connected, tuck them carefully inside the junction box.

Fig. 2 Wiring



Fixture Wires	House Wires
Black or Smooth	Black (Hot)
White or Ribbed	White (Neutral)
Bare wire (Ground)	Green or Bare Copper (Ground)

DIMMING WIRING INFORMATION (Fig. 3)

8. This fixture features electronic low voltage (ELV or TRIAC) or 0-10V dimming capabilities. See notes below for specific dimming wires information.
9. To utilize ELV or TRIAC dimming: use wires black (hot), white (neutral) and bare copper ground wire (ground).
10. To utilize 0-10V dimming: use wire purple (dim+), pink or gray (dim-), black (hot), white (neutral) and bare copper ground wire (ground).
 NOTE: Make sure to connect 0-10V prior to power-up the fixture in order to allow the 0-10V dimming to function properly.

Fig.4

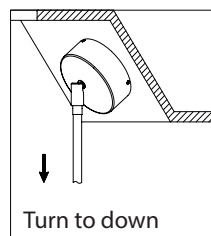

COMPLETING THE INSTALLATION (Fig. 1)

11. Secure the fixture to the mounting plate use the mounting screw (B).
12. Rotate the glass into the base.
13. For slope ceiling applications, rotate swivel at the top of the stem to ensure luminaire is aiming down (Fig.4).

Fig.3

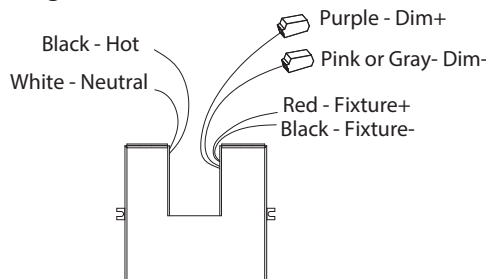

Mounting Plate Dimensions

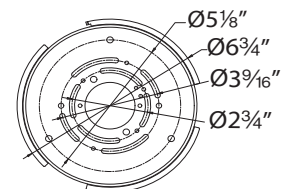

modernforms.com
 Phone (800) 526.2588
 Fax (800) 526.2585

Headquarters/Eastern Distribution Center
 44 Harbor Park Drive
 Port Washington, NY 11050

Central Distribution Center
 1600 Distribution Ct
 Lithia Springs, GA 30122

Western Distribution Center
 1750 Archibald Avenue
 Ontario, CA 91760

