

INSTALLATION INSTRUCTIONS

Item#2952-572 (New. 7/27/2021)

READ AND SAVE THESE INSTRUCTIONS

WARNING! SHUT POWER OFF AT FUSE OR CIRCUIT BREAKER.

AVERTISSEMENT! COUPER LE COURANT AU NIVEAU DES FUSIBLES OU DU DISJONCTEUR.

MOUNTING THE FIXTURE (Fig.1)

1. Shut off power at the fuse box or circuit breaker box and remove the old fixture including the mounting hardware.
2. Carefully unpack your new fixture and lay out all the parts in a clear area. Take care not to misplace any small parts necessary for installation.
3. Loosening screws (D) to remove mounting plate (A) from back plate (C).
4. Attach mounting plate (A) using the mounting screws (B) (Size: #8-32N*L0.5") to the junction box. The side of the mounting plate marked "GND" must face out.

CONNECTING THE WIRES (Fig. 2)

5. Connect the electrical wires as shown in Fig. 2, making sure that all wire connectors are secured. If your junction box has a ground wire (green or bare copper), connect the fixture's ground wire to it. Otherwise, connect the fixture's ground wire directly to the mounting plate (A) using the green screw provided. After wires are connected, tuck them carefully inside the junction box.

FINISHING THE INSTALLATION (Fig.1)

6. Place back plate (C) over mounting plate (A) and fasten with screws (D).
7. Place cloth shade (H) over back plate (C) and secure with screws (I).
8. Place candle covers (F) over sockets (E).
9. Install (2) two candelabra base bulbs (G) up to 60 watts each or CFL or LED equivalent (not included) in accordance with the fixture specification. —**DO NOT EXCEED THE MAXIMUM WATTAGE RATING! (NE PAS DEPASSER LA PUISSANCE NOMINALE MAXIMALE!**

Your installation is now complete. Return power and test the fixture.

Note: Illustration (Fig.1) on this manual is for installation purposes only. It may or may not be identical to the fixture purchased.

Fig. 1

Set#A-021-200160
-Mounting plate
-Ground screw
-Mounting screw*2

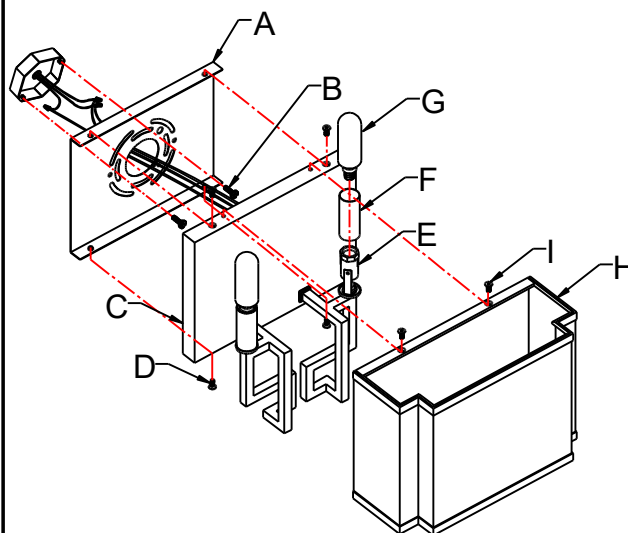

Candle cover#CCV21050P-613

Fig. 2

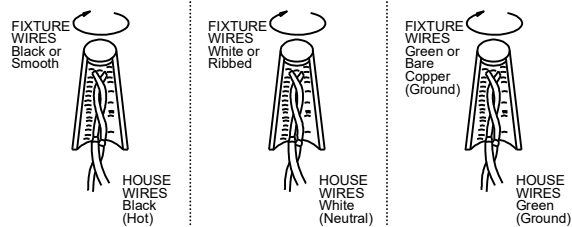

MIN 75°C SUPPLY CONDUCTORS