

INSTALLATION INSTRUCTION FOR FIXTURE #4663-598

**WARNING! SHUT POWER OFF AT FUSE OR CIRCUIT BREAKER.
AVERTISSEMENT! COUPER LE COURANT AU NIVEAU DES FUSIBLES OU DU DISJONCTEUR.**

MOUNTING THE FIXTURE (FIG. 1)

1. Shut off the power supply at the fuse box or circuit breaker. If necessary, remove the old fixture from wall. Including the mounting hardware.
2. Carefully remove the new fixture from the carton and check that all parts are included as shown in the illustration.
3. Lift mounting plate (B) to outlet box so that the screw holes in outlet box line up with slots on mounting plate (B), mark spots at outer keyholes for the plastic anchors (A) to be installed.
4. Drill pilot holes on spots marked and insert plastic anchors (A). (If fastening with wood screws to stud, ignore this step)
5. Attach mounting plate (B) to outlet box using the outlet box screws (D) (SIZE: #8-32N * L0.5").
6. Attach ends of mounting plate (B) to plastic anchors (A) or the spots that you marked on stud and secure with four wood screws (C).

Fig.1

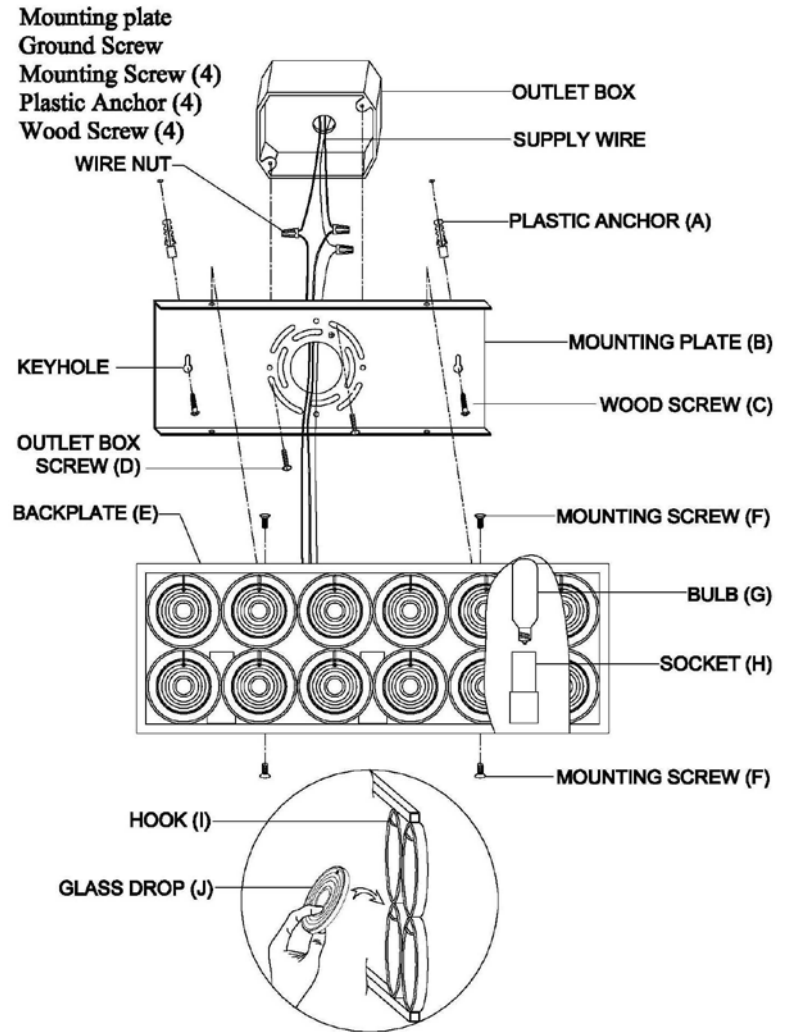

CONNECTING THE WIRES (FIG. 2)

7. At this point, connect the electrical wires as shown in Fig. 2, making sure that all wire nuts are secured. If your outlet box has a ground wire (green or bare copper), connect the fixture's ground wire to it. Otherwise, connect the fixture's ground wire directly to the mounting plate (B) using the green ground screw provided.
8. Tuck the wire connections neatly into the wall outlet box.

ASSEMBLE THE FIXTURE (FIG. 1)

9. Attach the backplate (E) onto the outlet box and secure with four mounting screws (F).
10. Attach the glass drops (J) to the hooks (I).
11. Install the T8 bulbs (G) (bulbs included) into the sockets (H).

(DO NOT EXCEED THE MAXIMUM WATTAGE RATING!) (NE PAS DEPASSER LA PUISSANCE NOMINALE MAXIMALE!).

Your installation is now complete. Return power to the junction box and test the fixture.

Min 75°C supply conductors.

Fig.2

