



CHUBBY II

BY

minkaAire[®]
A Minka Group[®] Co.

INSTRUCTION MANUAL WARRANTY CERTIFICATE

This product is protected by the United States Federal and/or State Law including Patent, Trademark, and /or Copyright Laws.

©2022 Minka Lighting Inc. Manual design and all elements of manual design are protected by United States Federal and/or State Law including Patent, Trademark and/or Copyright Laws.



Minka-Aire® warranty is for one (1) year from the date of purchase from an authorized Minka-Aire® dealer. This warranty is only valid to the original purchaser or user against all defects in material and workmanship (light bulbs excluded) for one (1) full year. Additionally, Minka-Aire® warrants the motor only for the lifetime of the Minka Aire ceiling fan (excluding wall controls and electrical components), to the original purchaser or user.

- * The warranty is voided with the use of any non- Minka-Aire® electrical devices, E.g., wall controls or electrical dimmer switches, etc...
- * The warranty is void once the original purchaser or user ceases to own the fan or the fan is moved from its original point of installation.
- * The warranty is void with the use of any hanger bracket (non-Minka Aire or non-fan specific) other than the hanger bracket supplied & installed with this specific fan.

Warranty Service Information

To obtain warranty service during the warranty period, the purchaser should return the fan with the sales receipt to the original place of purchase. The authorized Minka-Aire® dealer, at its sole discretion, will either repair or replace the fan after verifying the legitimacy of the warranty claim. Replacement is subject to availability of the same model. If the model is unavailable it will be replaced by one of equal value. This is a limited warranty; The original purchaser or user is responsible for the cost of removal and reinstallation of repaired or replacement product.

To obtain the name of the Minka-Aire® authorized dealer nearest you call the Minka-Aire® customer care department at 1-800-307-3267, or contact Minka-Aire® through www.minkagroup.net and select FAQ to answer any questions, or, if you require additional assistance, submit the the question form found there.

Date Purchased _____

Store Purchased _____

Model Number F782L

CONTENTS

SAFETY FIRST.....	1	INSTALLING THE LIGHT KIT.....	8
PACKAGE CONTENTS.....	2	OPERATING THE REMOTE CONTROL/WALL CONTROL...	9
BEGIN INSTALLATION.....	3	ENJOY YOUR SMART CEILING FAN	10
HANGING THE FAN.....	4	MAINTENANCE.....	11
ELECTRICAL CONNECTIONS.....	5	TROUBLE SHOOTING.....	12
FINISHING THE INSTALLATION	6	SPECIFICATIONS	13
ATTACHING THE FAN BLADES	7		



1151W. Bradford Court, Corona CA 92882 For Customer Assistance Call: 1-800-307-3267



1

SAFETY FIRST

1. Before you begin installing the fan, shut power off at the circuit breaker of the fuse box.
2. Be cautious! Read all instructions and safety information before installing your new fan. Review accompanying assembly diagrams.
3. Make sure that all electrical connections comply with local codes, ordinances, or National Electrical Codes. Hire a qualified electrician or consult a do-it-yourself wiring handbook if you are unfamiliar with installing electrical wiring.
4. Make sure the installation site you choose allows the fan blades to rotate without any obstructions. Allow a minimum clearance of 7 feet from the floor and 18 inches from the tip of the blades to the wall.
5. If you are mounting the fan to a ceiling fan outlet box, use a U.L. Listed metal octagonal outlet box marked Acceptable for Fan Support. Secure the box directly to the building structure. The outlet box and its support must be able to support the moving weight of the fan (at least 50 pounds) Do not use a plastic box.
6. Caution: To reduce the risk of injury use only the screws provided with the outlet box in conjunction with the lock washers provided with the fan.
7. If you are mounting the fan to a joist, make sure it is able to support the moving weight of the fan (at least 50 pounds).
8. After you install the fan, make sure that all mounting components are secured to prevent the fan from falling.
9. Do not insert anything into the fan blades while the fan is operating.
10. Turn the fan off and wait for the blades to stop completely before cleaning or performing any maintenance.

SUITABLE FOR USE IN
WET LOCATIONS

NOTE:The important safeguards and instructions appearing in this manual are not meant to cover all possible conditions and situations that may occur. It must be understood that common sense, caution and care are factors which can not be built into this product. These factors must be supplied by the person (s) installing, caring for and operating the unit.

NOTE: READ AND SAVE ALL INSTRUCTIONS!

WARNING

TO REDUCE THE RISK OF FIRE, ELECTRIC SHOCK OR OTHER PERSONAL INJURY. MOUNT FAN DIRECTLY TO THE BUILDING JOIST USING THE WOOD SCREWS AND WASHERS PROVIDED WITH THE FAN. THE WOOD SCREWS MUST GO THROUGH THE OUTLET BOX VIA THE KNOCK OUTS. CONSULT A QUALIFIED ELECTRICIAN IF IN DOUBT.

TO REDUCE THE RISK OF PERSONAL INJURY, DO NOT BEND THE BLADE HOLDERS WHILE INSTALLING, BALANCING THE BLADES, OR CLEANING THE FAN. DO NOT INSERT FOREIGN OBJECTS BETWEEN ROTATING FAN BLADES.

TO REDUCE THE RISK OF FIRE OR ELECTRONIC SHOCK, THIS FAN ONLY CAN USE MK1000-BOND RECEIVER AND RC1000 FAN REMOTE CONTROL ONLY.

2

PACKAGE CONTENTS

1. Fan blades(5)
 2. Mounting plate
 3. Fan motor/housing assembly
 4. 40W LED Light kit
 5. PC shade
 6. Light kit plate
 7. Remote control with holder
and 2mounting screws
(1.5Vx2AAA battery included)
 8. Receiver(9wire nuts included)
- A. Mounting hardware:
#10x38mm Wood screws(2 pcs)
#8-32x38mm Machine screws(2 pcs)
Lock washers (2 pcs)
4mm Star washers (2 pcs)
Washerw (2 pcs)
 - B. Blade attachment hardware:
3/16x13mm screw(16 pcs)
Φ5x14x1mm flat washer(16pcs)
 - C. Balance kit
 - D. Wire nut(3 pcs)

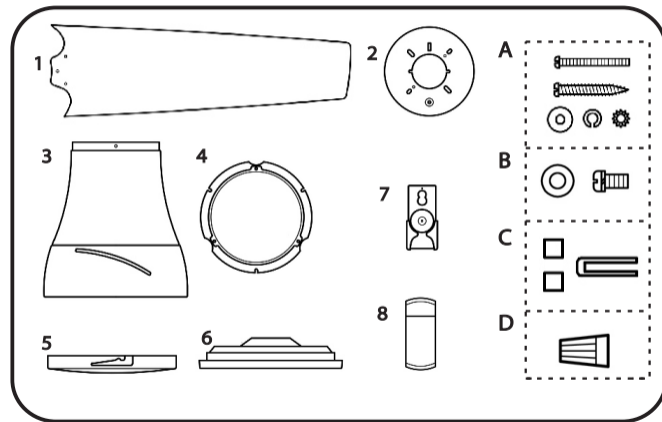

BEGIN INSTALLATION

Tools Required: Phillips screw driver; slotted screw driver; step-ladder; wire cutters; electrical tape.

WARNING: All of the parts, hardware and components have been provided for your safety and the proper installation of your new ceiling fan. The use of other parts, hardware or components not supplied by Minka Aire® with the fan will void the Minka Aire® Warranty.

REMEMBER to turn off the power. Follow the steps below to hang your fan properly;

Install the mounting plate onto the outlet box

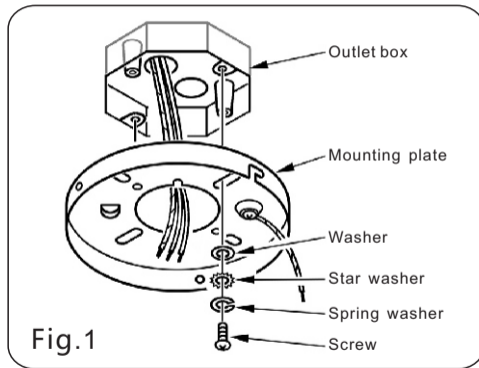

4

HANGING THE FAN

**Step 1: Remove 2 of 3 screw on canopy and loosen the last one screw.
(Fig.2)**

**Step 2: Have the cable hook onto the mounting plate as the drawing
for further installation(Fig.3)**

**Step 3: Have the receiver stay on the canopy for further wire connection.
(Fig.4)**

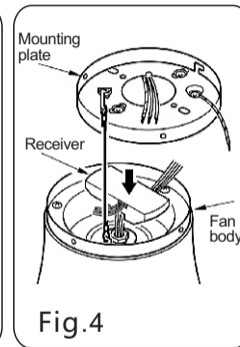
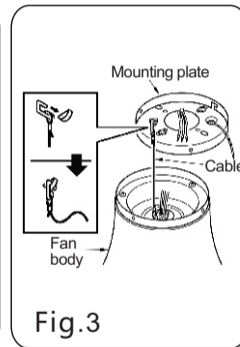
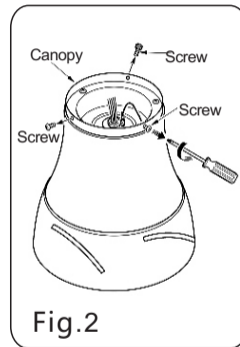

ELECTRICAL CONNECTIONS

5

WARNING: To avoid possible electrical shock be sure electricity is turned off at the main fuse or breaker box before wiring.

Note: The universal hand held remote control System is equipped with learning frequency function which has 1024 code combinations to prevent potential interference from other remote units. The frequency on your Receiver and Transmitter units have been preset at the factory. (Fig. 5). No frequency change is necessary, should you desire to install another fan within the same home or area with a separate frequency code please see the "frequency interference " troubleshooting section of this instruction manual to learn how to change the frequency.

Note: Fan must be installed from a maximum distance of 40 feet from the transmitting unit for proper signal transmission between the transmitting unit and the fan's receiving unit.

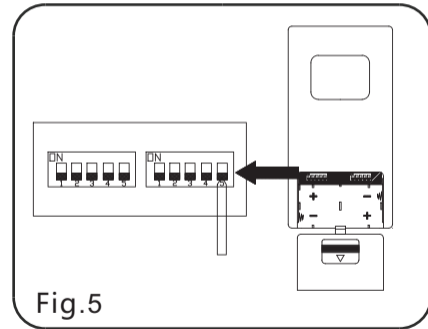

Fig.5

Step 1: Motor to Receiver electrical connections: connect the **WHITE WIRE** from the fan to the **WHITE** wire from receiver. Connect the **RED** wire from the fan to the **RED** wire from the Receiver. Connector the **BLUE** wire from the fan to the **BLUE** wire from the recelver. connect the **PURPLE** wire from the fan to the **PURPLE** wire from the receiver. Connect the **GREY** wire from the fan to the **GREY** wire from the receiver.(Fig. 6)

Step 2: Connect the fans ground wire (green) located on the mounting bracket to the household ground wire. Secure wire connection with the plastic wire nut provided.(Fig. 6)

Step 3: Receiver to House Supply Wires Electrical connections: Connect the **WHITE** wire from the outlet box to the **WHITE** wire from the receiver. Connect the **BLACK** wire from the outlet box to the **BLACK** wire from the receiver. Secure all wire connections with the plastic wire nuts provided. After all splices are made, check to make sure there are no loose strands.As an additional precaution we suggest to secure the plastic wire connectors to the wires with electrical tape.(Fig. 6)

WARNING: Changes or modifications not expressly approved by the party responsible for compliance could viod the user's authority to operate the equipment.

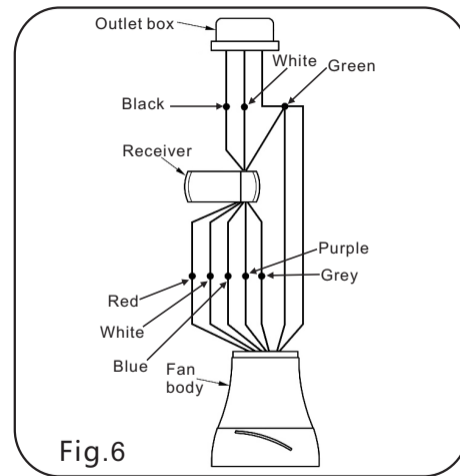

Fig.6

FINISHING THE INSTALLATION

Have the loosed screw hook on the L hole on mounting plate. Turn the fan body and make the other round holes on canopy align with mounting plate. Then, secure back the total 3 screws.(Fig. 7)

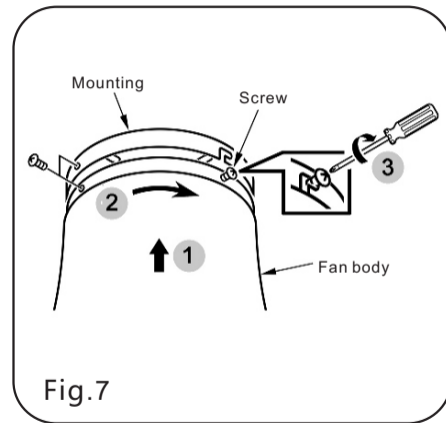

Fig.7

7

BLADE INSTALLATION

Assemble the blade onto the motor. Align the three holes of the blades with the motor and tighten them with the screw pack B (Fig. 8).

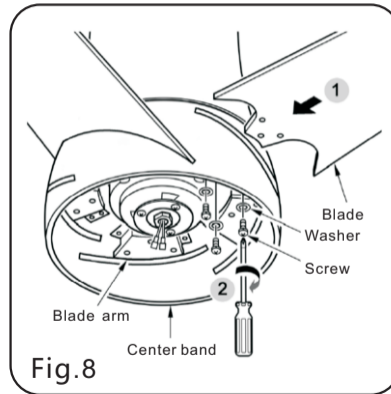

Fig.8

INSTALLING THE LIGHT KIT / INSTALLING THE SHADE

NOTE: Before starting installation, make sure power is turned off at the circuit breaker.

Step 1: Remove 1 of 3 screws on light kit adapter and loosen the other 2 screws.
(Fig. 9)

Step 2: Slide the light kit plate up towards the light kit adapter and place the key holes over the screws on the light kit adapter. Turn light kit plate until it locks in place at the narrow section of key holes.(Fig.10)

Step 3: Align the round hole of the light kit plate with light kit adapter,tighten all 3 screws.(Fig. 11)

Step 4: Remove the 3 screws from light kit plate And connect the wires between the fan and LED assembly with the connectors.(Fig. 12&13)

Step 5: Tighten the LED assembly to light kit plate with 3 screws.(Fig. 14)

Step 6: Align the slot of the light shade with the aised dimple on the light kit plate and turn it clockwise until it stops.(Fig. 15)

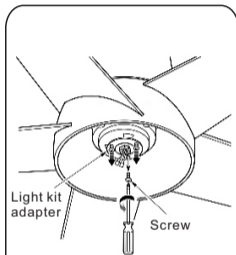

Fig.9

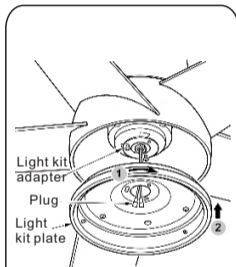

Fig.10

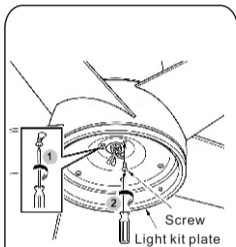

Fig.11

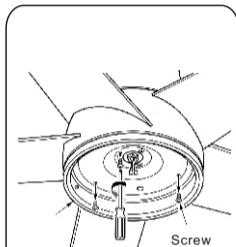

Fig.12

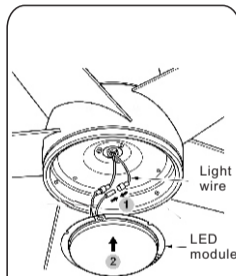

Fig.13

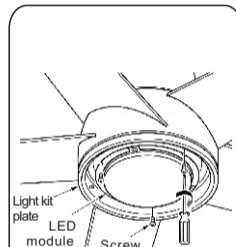

Fig.14

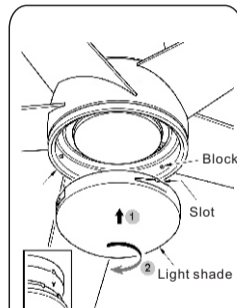

Fig.15

OPERATING THE REMOTE CONTROL/WALL CONTROL

Remote Control only: Install 2pcs AAA battery (included). To prevent damage to transmitter remove the battery if not used for long periods of time.

Your DC brushless motor is equipped with a self learning frequency function remote control. Restore power to ceiling fan and test the transmitter as below for proper operation:

A. 1, 2, 3, 4, 5 and 6 button:

These six buttons are used to set the fan speed as follows:

1 = minimum speed

2 = low speed

3 = medium low speed

4 = medium speed

5 = medium high speed

6 = high speed

B.  Reverse button:

This button is used to change the direction of the rotation of the blades; forward for warm weather or reverse for cold weather.

C.  button:

This button turns the power Off to the Fan.

D.  Button:

These buttons turn the light ON or OFF and also control the brightness settings of the light. The following instructions apply to ceiling fans that feature a DOWN light

( button) only or ceiling fans that feature an UP light ( button) and a DOWN light ( button) that are controlled independent of each other;

Press and release the button for the desired light to turn the light ON or OFF. Press and hold the button to set the desired light brightness. The light will cycle between bright and dim settings as long as the button is pressed. The light key has an automatic auto-resume feature that allows the light to remain at the same brightness as the last time it was turned off.

Speed settings for warm or cold weather depend on factors such as room size, ceiling height and number of fans.

NOTE: To change the direction of the rotation of the blades the fan must be in operation mode.

Warm Weather (forward)

A **DOWNWARD** airflow creates a cooling effect as shown in Figure 16. This allows you to set your air conditioner on a warmer setting without affecting your comfort.

Cool Weather (Reverse)

An **UPWARD** airflow moves warmer air off the ceiling area as shown in Figure 17. This allows you to set your heating unit on a cooler setting without affecting your comfort.

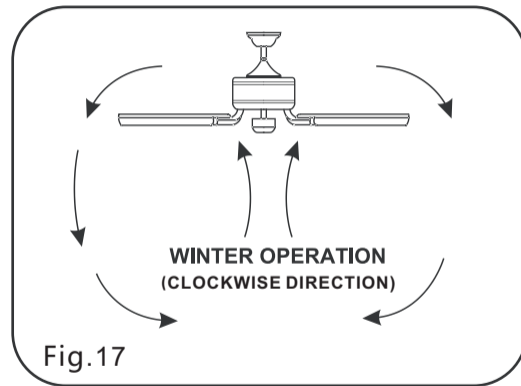
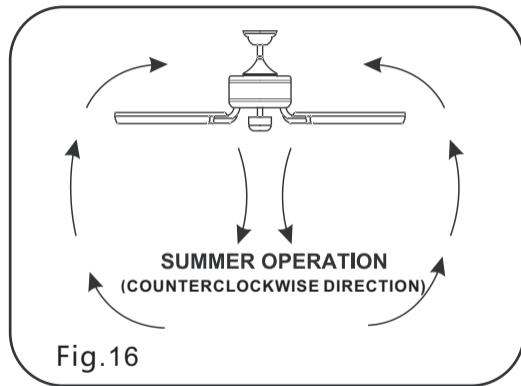

ENJOY YOUR SMART CEILING FAN

NOTE: Before moving on to learning about your new smart ceiling fan, please be sure to test all your fans functionalities using your remote control first.

To enjoy all the potential of your new ceiling fan. You'll need to download the BOND HOME app. Available on the Google and Apple Play Store.

You can use the QR code shown in (Fig. 18) to download the app, or you can download the app by visiting https://bondhome_io/app and follow the prompts.

NOTE: Please turn to our "Troubleshooting section" for additional information on your Smart Ceiling Fan.



Fig.18

Scan QR Code

CARE OF YOUR FAN

Here are some suggestions to help you maintain your fan.

1. Because of the fan's natural movement, some connections may become loose. Check the support connections, brackets, and blade attachments twice a year. Make sure they are secure (It is not necessary to remove fan from ceiling.)
2. Clean your fan periodically to help maintain its new appearance over the years. Do not use water when cleaning. This could damage the motor, or the wood, or possibly cause an electrical shock.
3. Use only a soft brush or lint-free cloth to avoid scratching the finish. The plating is sealed with a lacquer to minimize discoloration or tarnishing.
4. You can apply a light coat of furniture polish to the wood for

additional protection and enhanced beauty. Cover small scratches with a light application of shoe polish.

5. There is no need to oil your fan. The motor has permanently lubricated bearings.

WARNING

MAKE SURE THE POWER IS OFF AT THE ELECTRICAL PANEL BOX BEFORE YOU ATTEMPT ANY REPAIRS. REFER TO THE SECTION, 'MAKING ELECTRICAL CONNECTIONS'.

TROUBLESHOOTING

SYMPTOM

Fan will not start

SOLUTION

1. Check to make sure the wall switch is turned on.
2. Check circuit fuses or breakers.
3. **Caution!** Make sure the power is turned off before performing the following steps.
4. Remove canopy and check wire connections.
5. Check wall control transmitter connections (if applicable).
6. **Note:** Fan must be installed from a maximum distance of 40 feet from the transmitting unit for proper signal transmission between the transmitting unit and the fan's receiving unit.

SYMPTOM

Fan sound noisy

SOLUTION

1. Allow a 24-hour 'break in' period. Most noises associated with a new fan will go away during this time.
2. Make sure all blade attachment screws are tight.
3. Make sure outlet box is secured to building structure, if necessary use the wood screws provided to further secure outlet box to joist.
4. Make sure hanger bracket is secure to the outlet box, screws are tight.

SYMPTOM

Fan Wobble

SOLUTION

1. **NOTE:** All blade sets are grouped by weight. Because wood and plastic blades vary in density, the fan may wobble even though blades are matched.
2. Make sure outlet box is secured to building structure, if necessary use the wood screws provided to further secure outlet box to joist.
3. Make sure hanger bracket is secure to the outlet box, screws are tight.
4. Use the balancing kit provided if the wobble is excessive (follow instructions included with balance kit)

SYMPTOM

Frequency interference

SOLUTION

1. Turn the power off to your ceiling fan.
2. Please use a small size tool to change the frequency setting on the control system.
3. Return power to the unit Note: After the AC power is on, do not press any other button on the transmitter before pressing the "Stop" button, doing so will cause the procedure to fail.
4. Within **60** seconds of turning the Fan's AC power ON. Press the transmitter's Stop" button for 5 seconds.
5. Once the receiver has detected the frequency, the fan will automatically begin to operate and start to rotate in the counter-clockwise direction and on the lowest Speed setting. The fan will continue to spin until the "STOP" button has been pressed.
6. The receiver has now learned the frequency which has been selected on the transmitter. After completing the steps above, you should be able to operate the ceiling fan and light. If the fan is not responding to the transmitter, please turn the power off to the receiver, and repeat the process.

SYMPTOM

Does not connect to WiFi home network.

SOLUTION

If you are having trouble completing the Bond Home connection with your ceiling fan, adjustments to your router settings may be needed please go to the Help Center section in the app under the Settings for additional information and support.

Wifi resetting

If you wish to clear the Wifi setting from the app for a specified fan. You may do so by going into the app settings and removing the desired device. This will clear any wifi settings saved onto the device, and will allow you to reconnect it elsewhere with new wifi settings.

SPECIFICATIONS

These are typical readings. Your actual fan may vary. They do not include amps and wattage used by the light (s).

For any additional information about your Minka Aire® Ceiling fan, please write to:

Fan Size	Speed	Volts	Amps	Watts	RPM	N.W.	G.W.	C.F.
58"	Low	120	0.11	4.61	53	9.2 kgs	11.9 kgs	3.60'
	High	120	0.56	36.11	135			



1151 W. Bradford Court, Corona, CA 92882 • For Customer Assistance Call: 1-800-307-3267

ENERGYGUIDE

Estimated
Yearly Energy Cost

\$7

\$3 | | | \$34

Cost Range of Similar Models (19"—84")

- Based on 12 cents per kWh and 6.4 hours use per day
- Your cost depends on rates and use
- Energy Use: 24 Watts

All estimates based on typical use, excluding lights

Airflow

4,661

Cubic Feet Per Minute

- The higher the airflow, the more air the fan will move
- Airflow Efficiency: 196 Cubic Feet Per Minute Per Watt

ftc.gov/energy

FAN SPEED	AIRFLOW (CFM)*	POWER USE (watts)	AIRFLOW EFFICIENCY (CFM/watt)
Low	2656	4.61	576
High	6431	36.11	178

Ceiling fan airflow is measured in cubic feet per minute (CFM). Power use is measured in watts. To maximize energy savings:

- Choose a fan with high airflow efficiency (CFM/watt).
- Use ENERGY STAR®-labeled lighting in your fan.
- Remember to switch off your fan when you leave the room.

* Measured according to the DOE approved Solid State test method

minkaAire[®]
A Minka Group[®] Co.

For any additional information about your Minka Aire[®] Ceiling fan, please write to:

1151 W. Bradford Court, Corona, CA 92882 • For Customer Assistance Call: 1-800-307-3267

MKA21111902

← English Verison

