

METRO ILLUMINATED

903352FBN-LIA

METRO ILLUMINATED 52" FAN

DETAILS	
FAN FINISH:	Brushed Nickel
GLASS:	Etched Opal
BLADE COUNT:	5

DIMENSIONS	
WIDTH:	52"
HEIGHT:	18.5"
TOP TO OUTLET:	0"

LIGHT SOURCE	
VOLTAGE:	120v

MOUNTING	
CANOPY:	6" Dia.
LEAD WIRE:	1 x 76"



Metro Illuminated evokes a sense of timeless tradition to interiors of all styles. Metro Illuminated is available in Brushed Nickel with Silver or Matte Black blades, Chalk White with Chalk White or Weathered Wood blades, Matte Black with Matte Black or Walnut blades, Metallic Matte Bronze with Metallic Matte Bronze or Walnut blades. Metro Illuminated features an LED lamps and is part of the Regency Collection.

PRODUCT DETAILS:

- This item includes a 4.5" down rod. Various lengths are available to customize the installation height.
- Suitable for use in dry (indoor) locations as defined by NEC and CEC. Meets United States UL Underwriters Laboratories & CSA Canadian Standards Association Product Safety Standards
- This item may be hung on a sloped ceiling
- Pull chain manual reverse, accessory controls available
- Fan mounts directly to canopy or with an included downrod for dual mount capability
- Each customizable blade offers two finish options; simply reverse the blade to select your preferred finish.
- The Regency Series features a range of traditional ceiling fans designed to enhance a wide variety of spaces with ease.
- LED Lamps carry a 3-year limited warranty

HINKLEY

HINKLEY
33000 Pin Oak Parkway
Avon Lake, OH 44012

PHONE: (440) 653-5500
Toll Free: 1 (800) 446-5539

hinkley.com

METRO ILLUMINATED 52" FAN

903352FBN-LIA

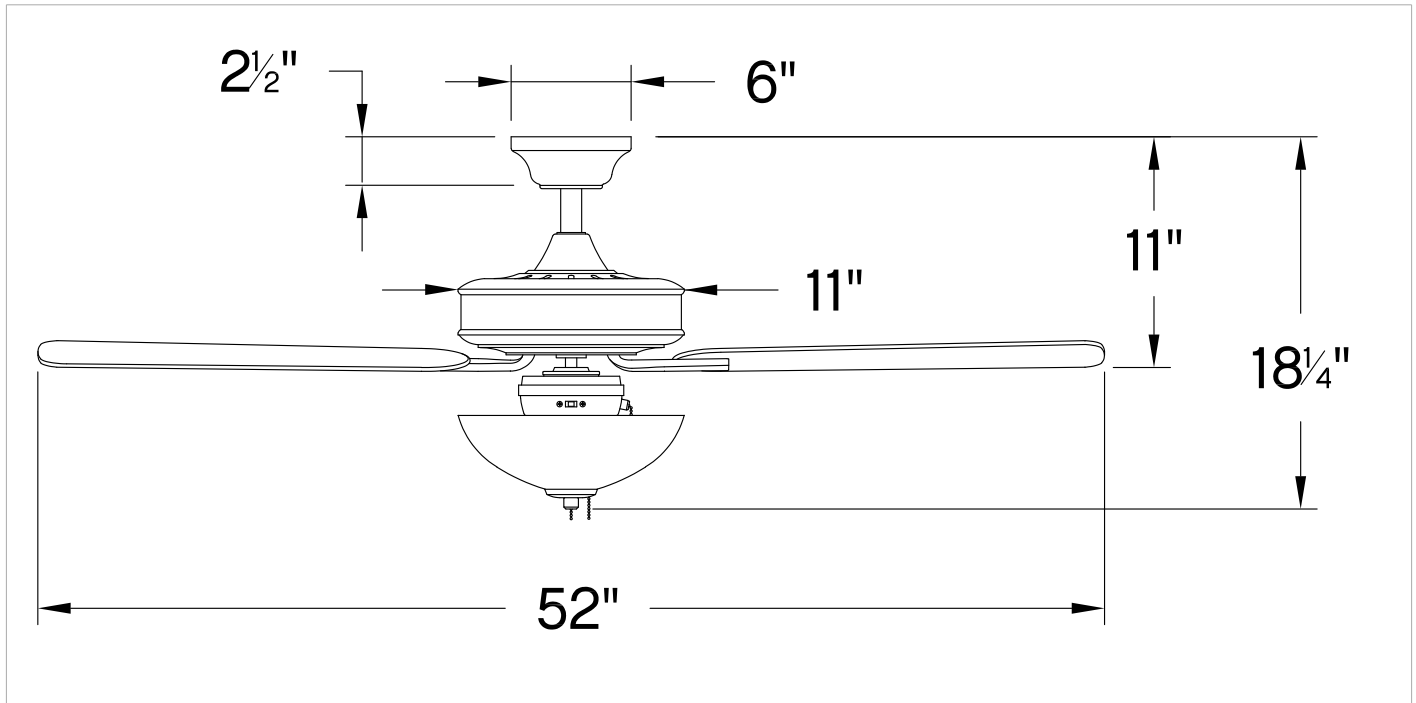

PERFORMANCE SPECIFICATIONS	STANDARD		DUAL MOUNT	
	HIGH SPEED	AVERAGE SPEED	HIGH SPEED	AVERAGE SPEED
Airflow	4577	3427	4443	4443
EnergyUse	58.3	36	61.8	38
EnergyCost	16	10	17	11
Efficiency	79	88	71.9	84
AMPS	0.5	0.36	0.52	0.38
RPMS	154	105	162	36

AVERAGE PERFORMANCE AND ENERGY INFORMATION

ENERGYGUIDE

Estimated
Yearly Energy Cost
\$11

\$3 | | | \$34

Cost Range of Similar Models (19" – 84")

• Based on 12 cents per kWh and 6.4 hours use per day
 • Your cost depends on rates and use
 • Energy Use: 38 Watts

Airflow
3,427
Cubic Feet Per Minute

• The higher the airflow, the more air the fan will move
 • Airflow Efficiency: 90 Cubic Feet Per Minute Per Watt

All estimates based on typical use, excluding lights ftc.gov/energy

Airflow Shown is a Weighted Average of High and Low Cubic Feet per Minute Based on Downrod

HINKLEY

HINKLEY
33000 Pin Oak Parkway
Avon Lake, OH 44012

PHONE: (440) 653-5500
Toll Free: 1 (800) 446-5539

hinkley.com