









shown in Gloss White
with 52" blades



America

The America fan is a practical solution for both residential or commercial spaces with a more traditional aesthetic. It is available with either 42 or 52 inch diameters, along with an optional light kit. The blades are reversible as either white or light oak tone finish. The America carries a limited lifetime warranty.

Product Features

 American Labor	 AC Motor	 LED Lamp	 Dry Location	 Silent	 30° Slant Ceiling Canopy	 60° Cathedral Ceiling Canopy	 Unipack Shipping
---	---	---	---	---	---	---	---

USA

Applicability to Buy American Act:

Domestic Construction Materials Clause (Feb 2009): 52-225-9 (4)(2)(i). The cost of its components mined, produced, or manufactured in the United States exceeds 50 percent of the cost of all its components.

Breakdown of Origin of Materials:

Ceiling fan parts are made in Taiwan, a World Trade Organization Government Procurement Agreement country. Final assembly and UL 507 electrical compliance testing will be done in the US. US labor will be used in the assembly, handling and testing of this fan.

ITEM	ORIGIN	% of COST of ITEM
Fan Components	Taiwan	41.18%
U.S. Labor MFC Facility*	USA	34.46%
Domestic Shipping	USA	10.34%
International Shipping	USA	11.20%
US Duty	USA	1.96%
Shipping Insurance	USA	0.88%

* US labor cost includes, but is not limited to: hands-on assembly, packaging and warehousing.

Taiwan

Applicability to Buy American Act - Construction Materials Under Trade Agreements:

Construction Materials Clause (Aug 2009): 52-225-11 as prescribed in 25-1102. Ceiling fan parts and assembly comprise a "WTO GPA country end-product."

Breakdown of Origin of Materials:

Ceiling fan is made in Taiwan, a World Trade Organization Government Procurement Agreement country.

ITEM	ORIGIN	% of COST of ITEM
Ceiling Fan Components/ Assembly Labor	Taiwan	74.59%
Shipping/ Handling / Insurance / Duty	USA	25.41%

AMERICA

FINISH AND BLADE OPTIONS

SKU#	AM-WH-XX-XX-XX (Origin+Light Kit+Diameter)	
Origin	USA Taiwan	US TW
Light Kit	Without Light Kit Light Kit	NA LK
Fan Diameter	42 inches / 107 cm 52 inches / 132 cm	42 52

TECHNICAL SPECS

Fan Diameters	inches: 42 or 52 centimeters: 107 or 132
Blade Material	MDF
Overall Drops with both standard downrods: 3" and 9"	13" without light kit and 3" downrod 19" with light kit and 3" downrod 19" without light kit and 9" downrod 25" with light kit and 9" downrod
Fan Weight	21 lbs
Downrods Lengths <i>Field cuttable.</i> <i>Non-threaded</i>	inches: 5, 10, 20, 30, 48, 72 centimeters: 13, 25, 51, 76, 122, 183
Downrod Diameter	1 inch
Lead length	78"
Voltage	110 or 220
Motor Type	AC
Motor size	172 mm x 14 mm (3 speeds and forward/reverse)
Mounting	Vaulted ceiling canopy for up to 29°
Control	Pull-chain (Wall control available as accessory)
Light kit	Available as accessory with X2 GU24 sockets and frosted glass bowl. LED lamps.
Ambience	Silent
Safety Certification	UL Listed - Dry Location
Warranty	Limited Lifetime

LIGHT KIT PHOTOMETRICS

Lamping (Replaceable)	LED
Delivered Temperature in K	3000
Delivered Lumens	805 (x2)
Watts	18 (x2)
Hours	25,000
Light kit longevity if used 6 Hours/Day: 11.4 Years	



NEW JAN 21, 2020 DOE MOTOR EFFICIENCY DATA

	With 3" Downrod	With 3" Downrod	With 9" Downrod	With 9" Downrod
	42 inch 107 cm	52 inch 132 cm	42 inch 107 cm	52 inch 132 cm
RPM (Low / High)	87 / 243	54 / 162	93 / 249	57 / 166
CFM (Low / High)	1488 / 4204	1313 / 4083	1419 / 4050	1699 / 4643
Watts (High)	60.00	64.67	61.00	59.00
CFM/Watt (High)	58.00	63.14	58.00	79.00
Blade Pitch	12°	12°	12°	12°

STANDARD EQUIPMENT

One downrod of 3 inches / 8 cm
One downrod of 9 inches / 23 cm
Vaulted ceiling canopy for up to 30°



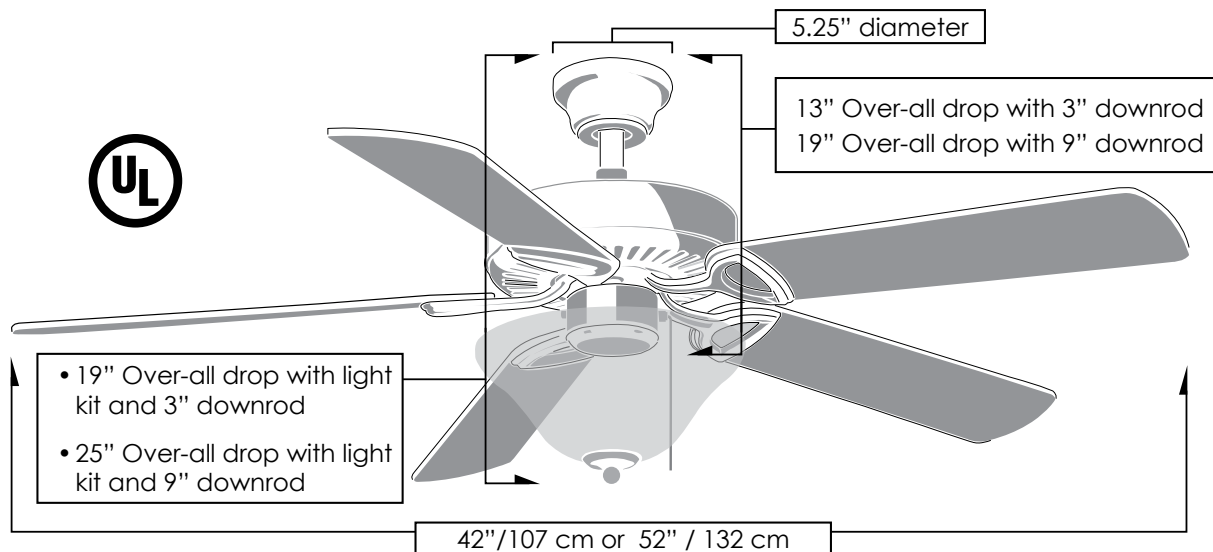

USA

Applicability to Buy American Act:

Domestic Construction Materials Clause (Feb 2009): 52-225-9 (4)(2)(i). The cost of its components mined, produced, or manufactured in the United States exceeds 50 percent of the cost of all its components.

Breakdown of Origin of Materials:

Ceiling fan parts are made in Taiwan, a World Trade Organization Government Procurement Agreement country. Final assembly and UL 507 electrical compliance testing will be done in the US. US labor will be used in the assembly, handling and testing of this fan.

ITEM	ORIGIN	% of COST of ITEM
Fan Components	Taiwan	41.18%
U.S. Labor MFC Facility*	USA	34.46%
Domestic Shipping	USA	10.34%
International Shipping	USA	11.20%
US Duty	USA	1.96%
Shipping Insurance	USA	0.88%

* US labor cost includes, but is not limited to:
hands-on assembly, packaging and warehousing.

Taiwan

Applicability to Buy American Act - Construction Materials Under Trade Agreements:

Construction Materials Clause (Aug 2009): 52-225-11 as prescribed in 25-1102. Ceiling fan parts and assembly comprise a "WTO GPA country end-product."

Breakdown of Origin of Materials:

Ceiling fan is made in Taiwan, a World Trade Organization Government Procurement Agreement country.

ITEM	ORIGIN	% of COST of ITEM
Ceiling Fan Components/ Assembly Labor	Taiwan	74.59%
Shipping/ Handling / Insurance / Duty	USA	25.41%

CEILING PITCH TABLE

0/12	0 degrees
1/12	4.76 degrees
2/12	9.46 degrees
3/12	14.04 degrees
4/12	18.43 degrees
5/12	22.62 degrees
6/12	26.57 degrees
7/12	30.26 degrees
8/12	33.69 degrees
9/12	36.87 degrees
10/12	39.81 degrees
11/12	42.51 degrees

CEILING HEIGHT / DOWNROD TABLE

Ceiling Height	Downrod Lengths <i>Field cuttable. Non-threaded</i>
10 ft or less	3 inches / 13 cm
10 -12 feet	10 inches / 25 cm
13 feet	20 inches / 51 cm
14 feet	30 inches / 76 cm
15 feet	48 inches / 122 cm
16 feet +	72 inches / 183 cm

Matthews Fan Company

1881 Industrial Drive
Libertyville, IL 60048
Tele: 847.680.9043
Fax: 847.680.8140
www.matthewsfanco.com

© 2023 Matthews Fan Company. All rights reserved.

