

TITANIA

design Alberto Meda / Paolo Rizzatto

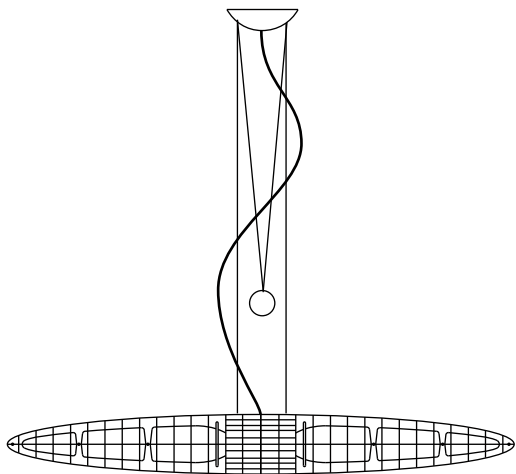

**LUCE
PLAN**

D17



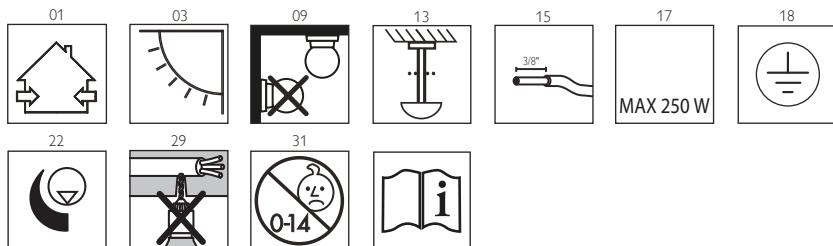

D17

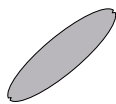
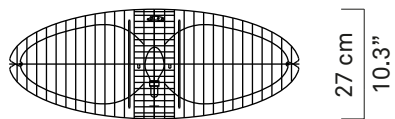
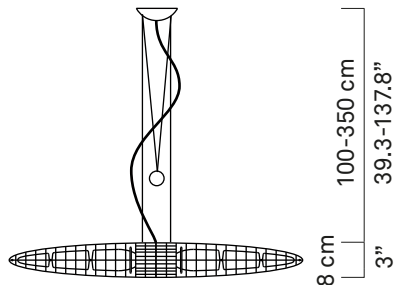

x10

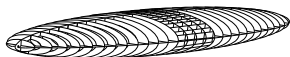

x1



x1



x1



x2



x1



x1



x1



x1



x1



kg 1,3 kg

lb 2.9 lb



250W T-10
halogen/frosted
shielded
med. base

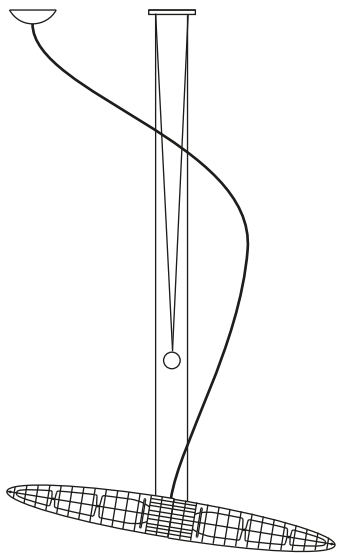
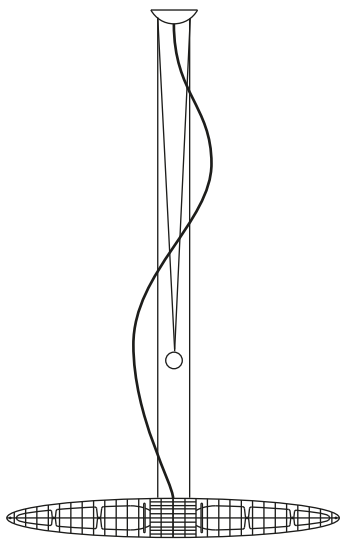

1

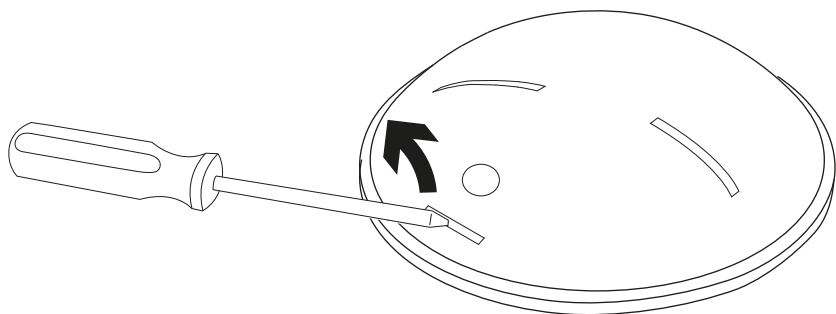

1.1

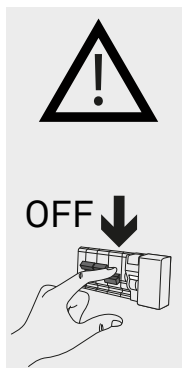

 yellow/green
jaune/vert
amarillo/verde

L black
noir
negro

N white
blanc
blanco

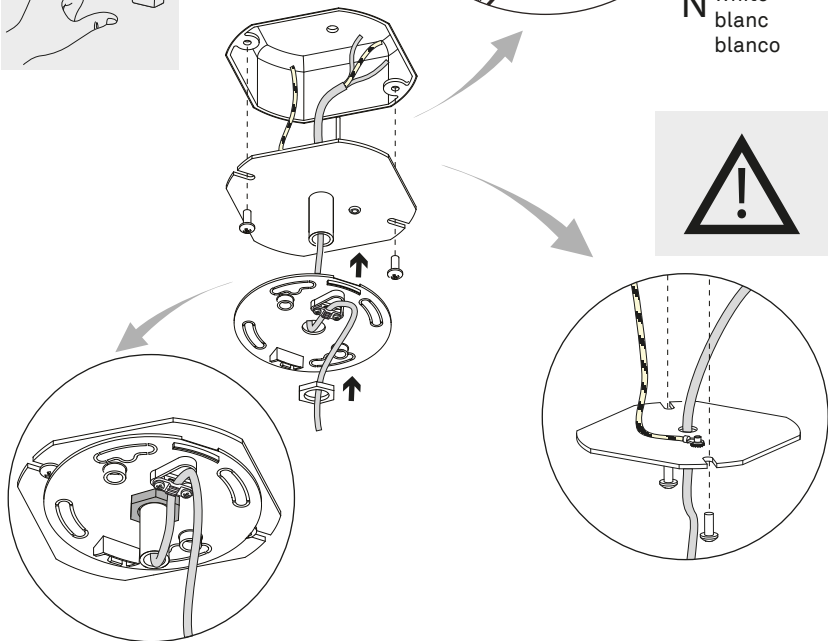

2

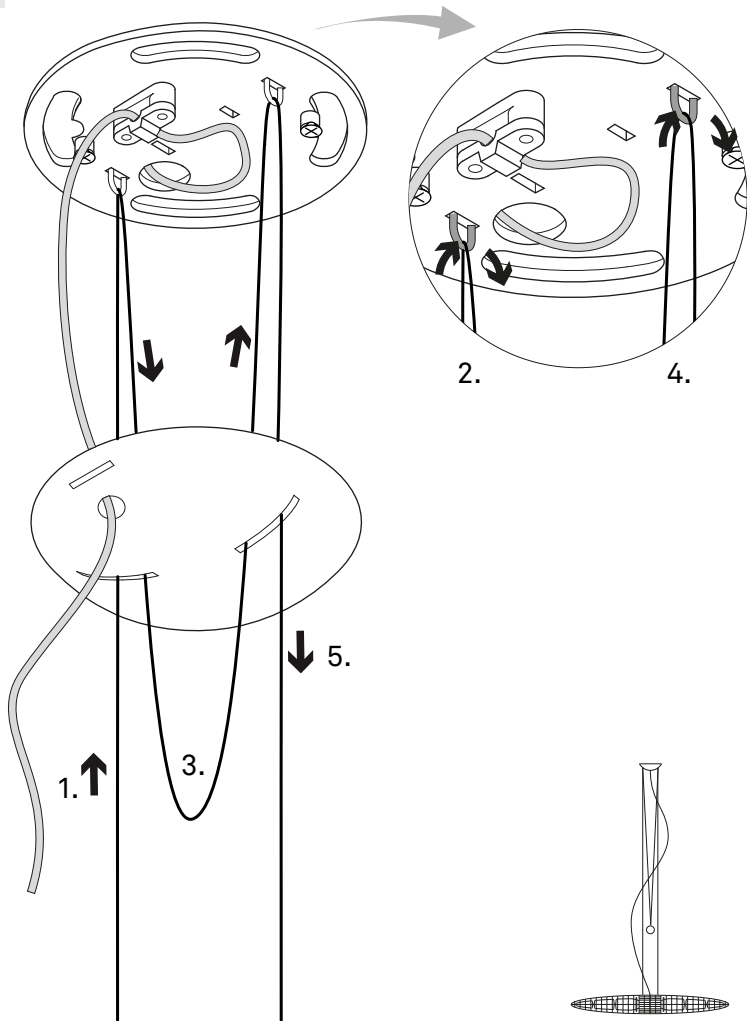

2.1

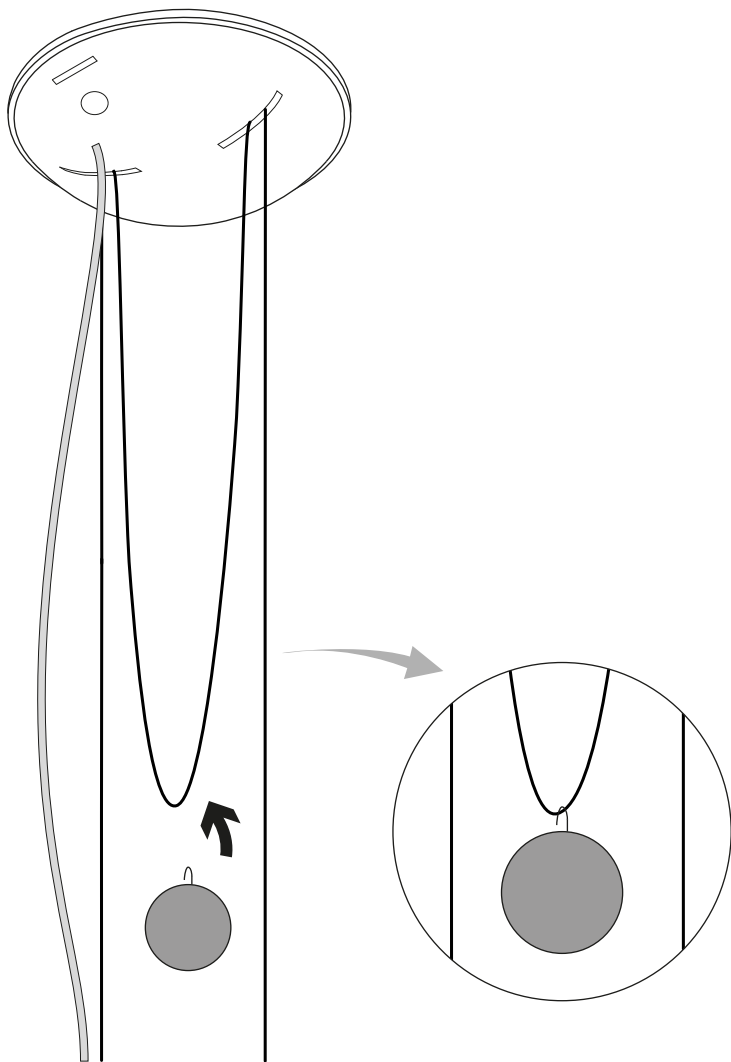

2

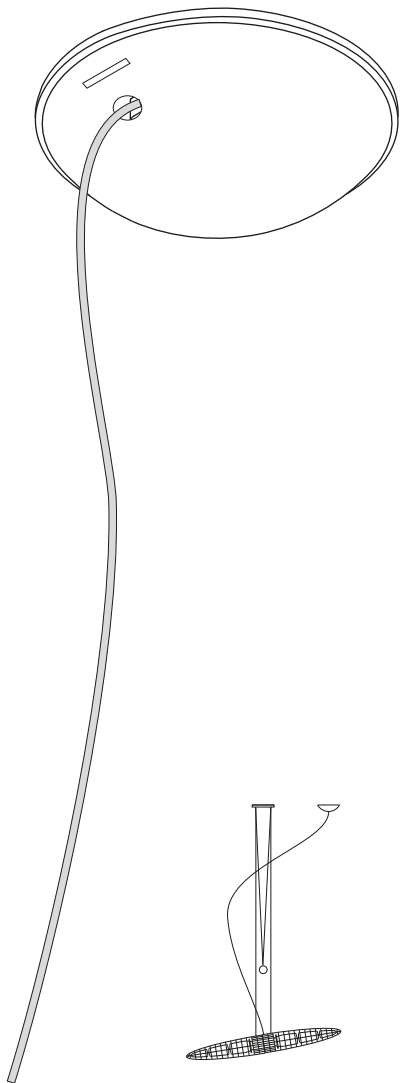
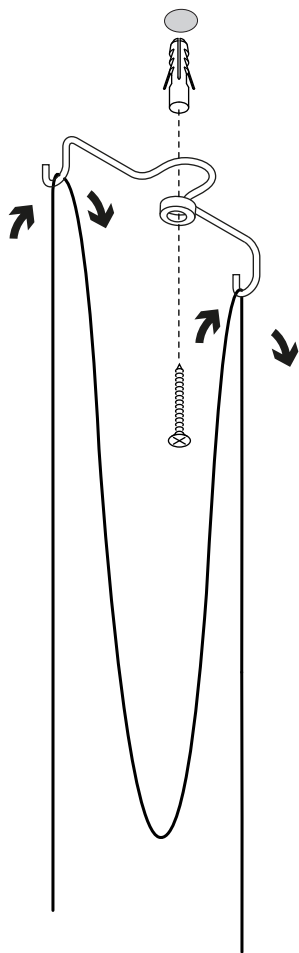

2.1

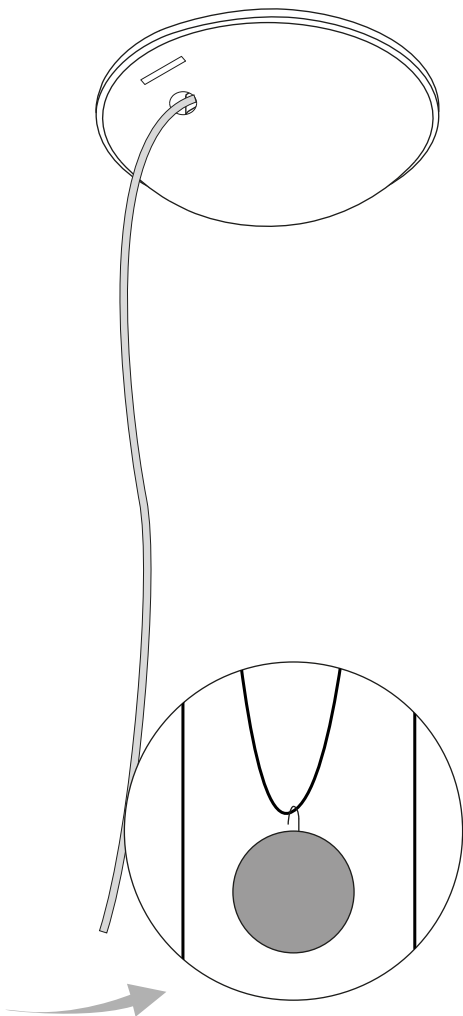
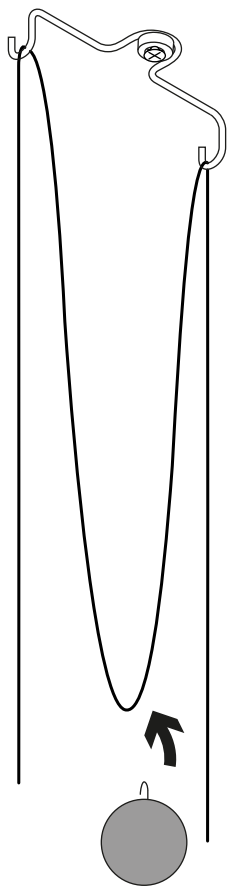

3 x2

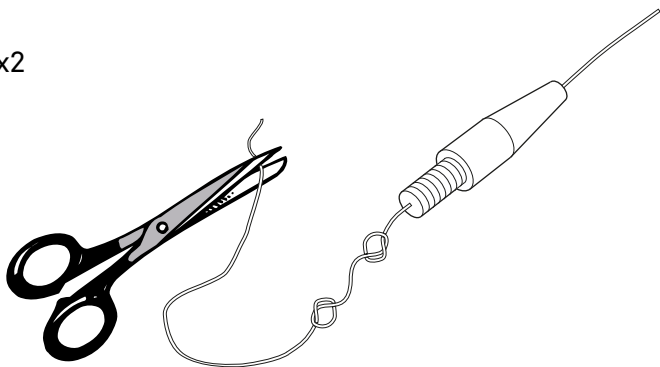

3.1

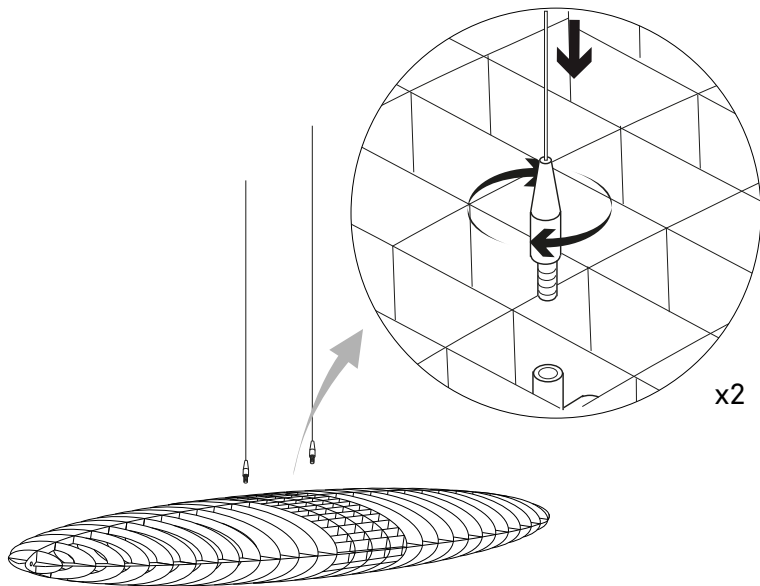

3.2

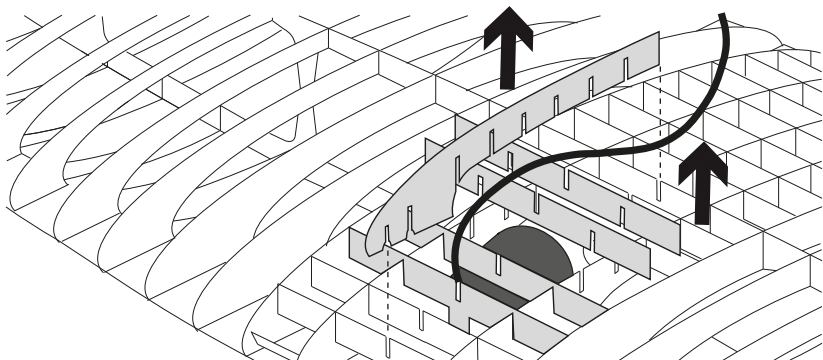

3.3

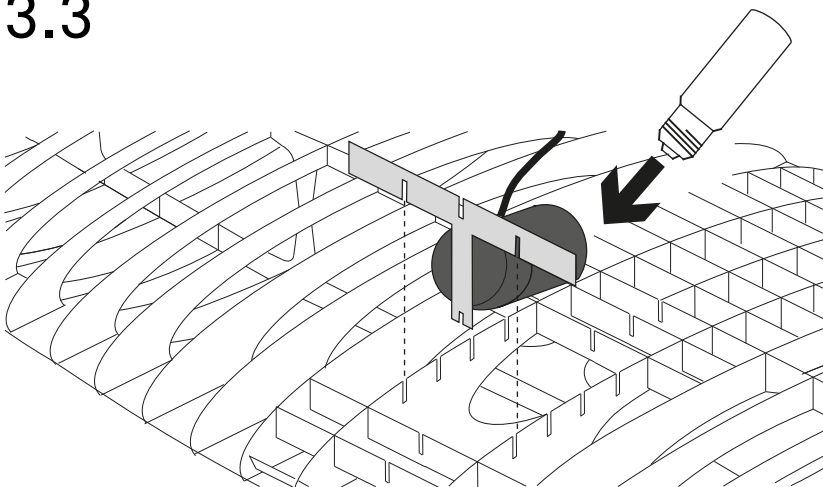

3.4

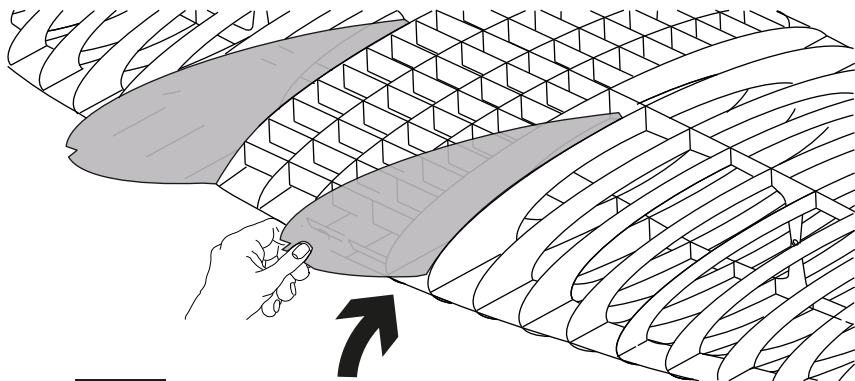
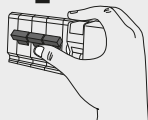
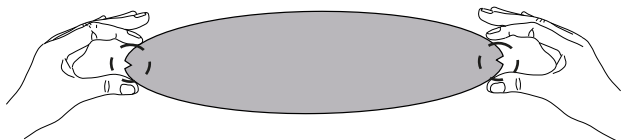

**LUCE
PLAN**



www.luceplan.com

D170I0104