

SOLEIL NOIR

design Odile Decq

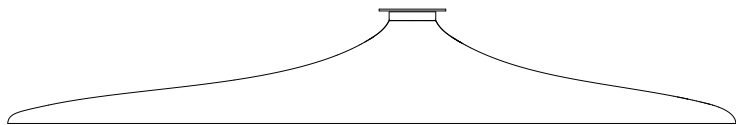

**LUCE
PLAN**

D89p



D89p

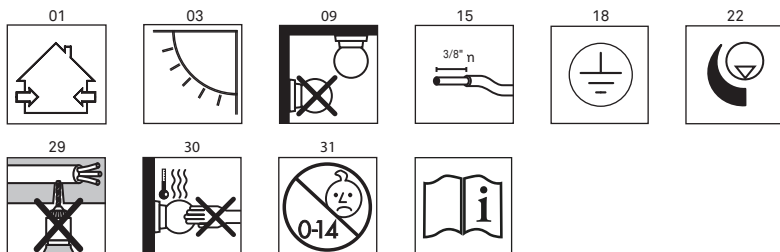

D89p

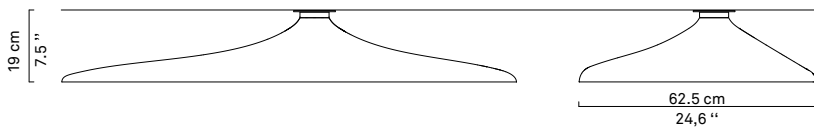
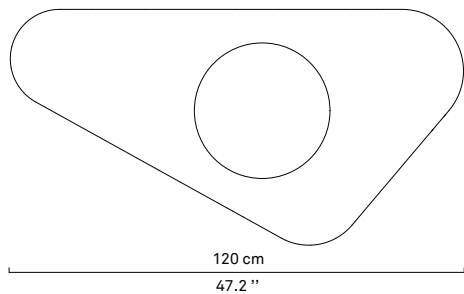

kg 6.1 kg **lb** 13.5 lb

D89p



a



b

x1

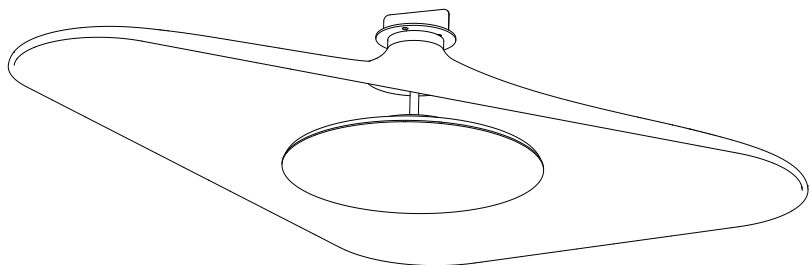

D89p

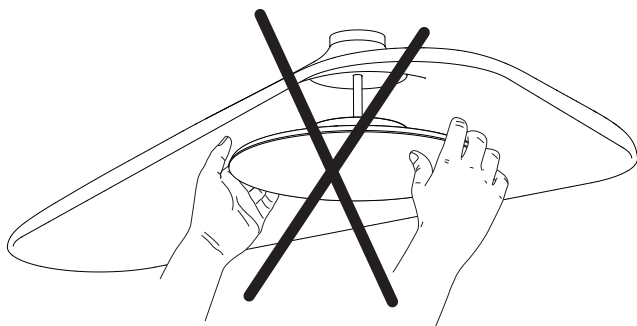
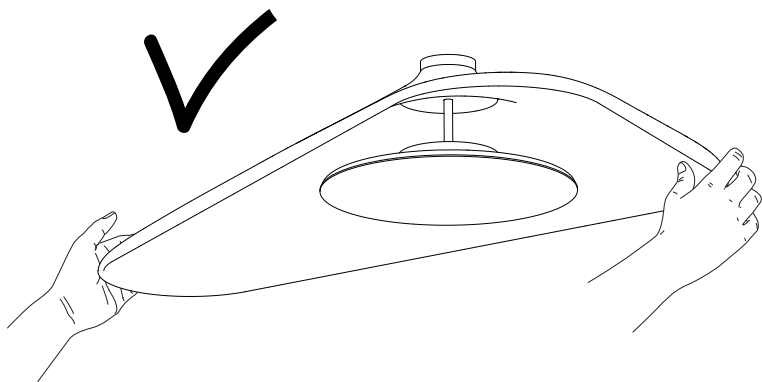

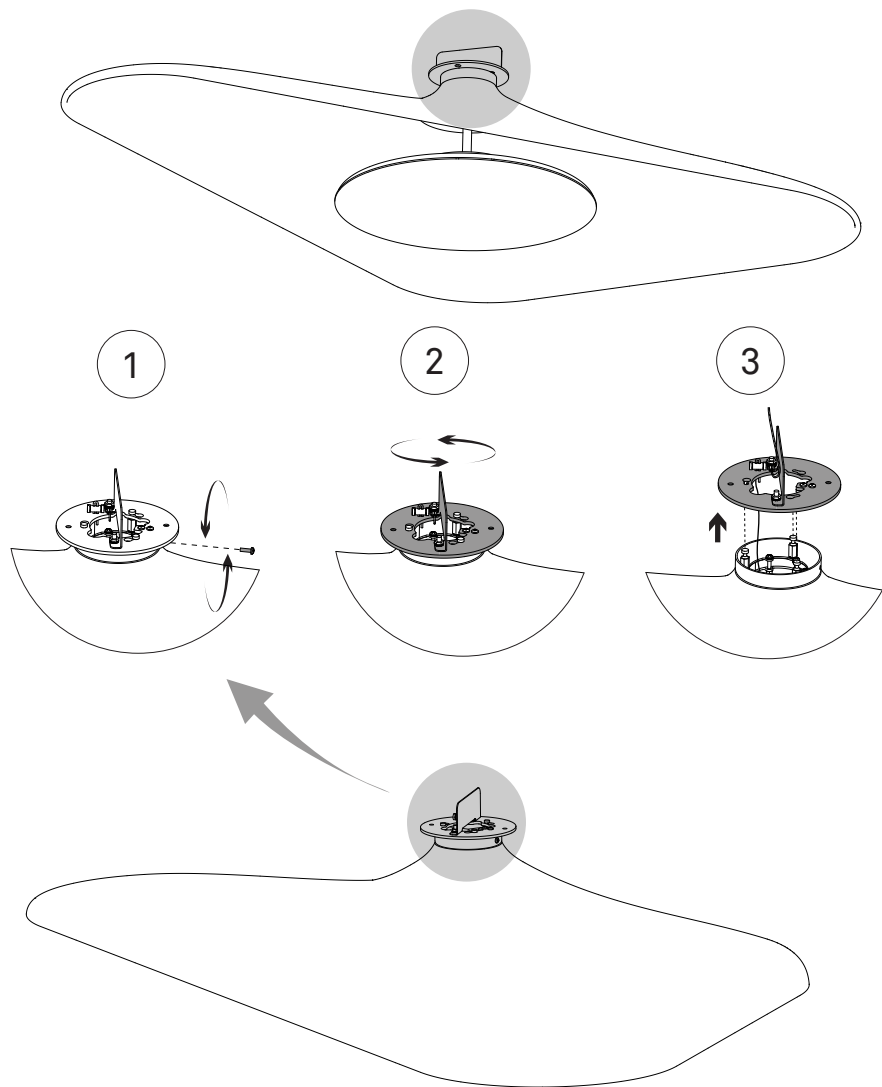

D89p

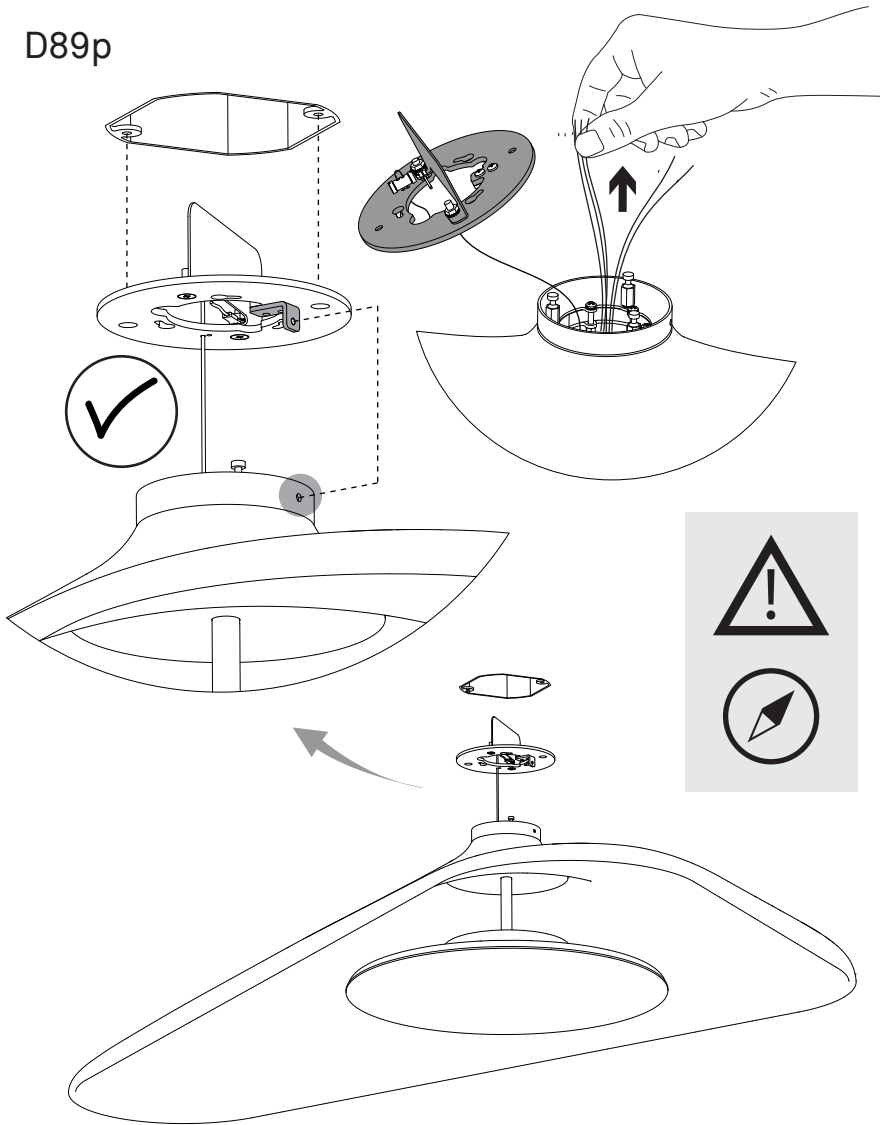

D89p

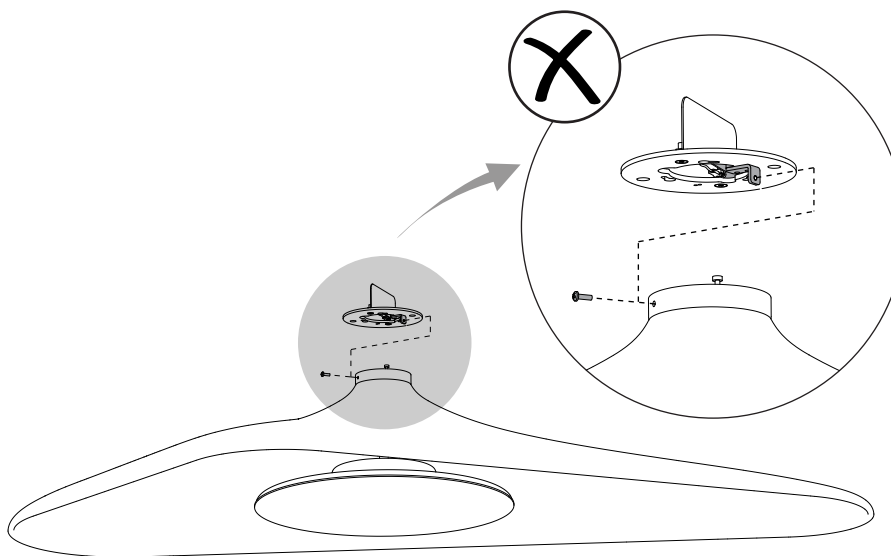
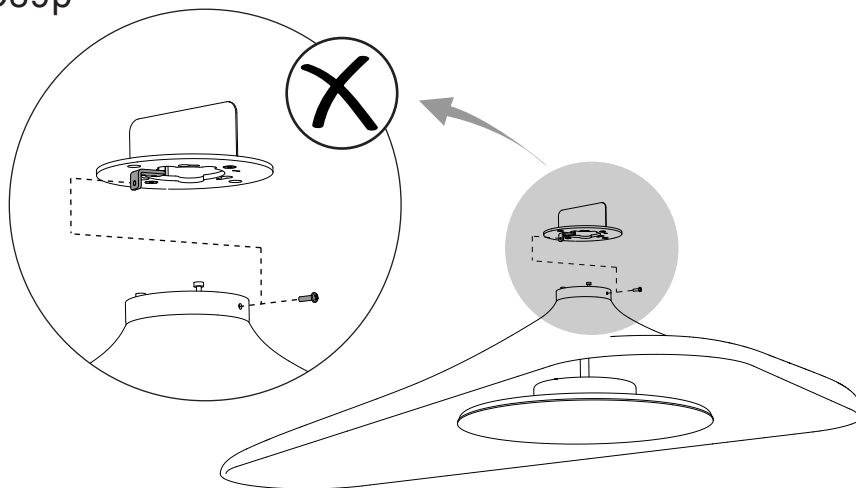

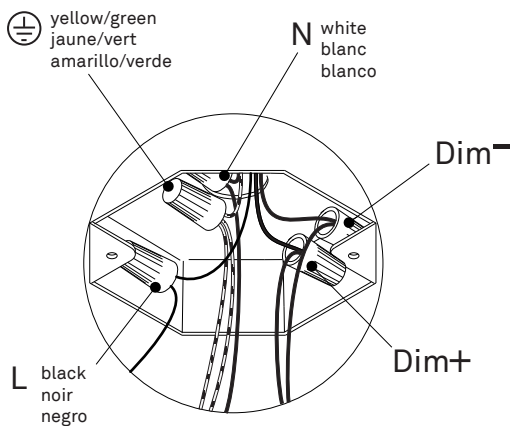
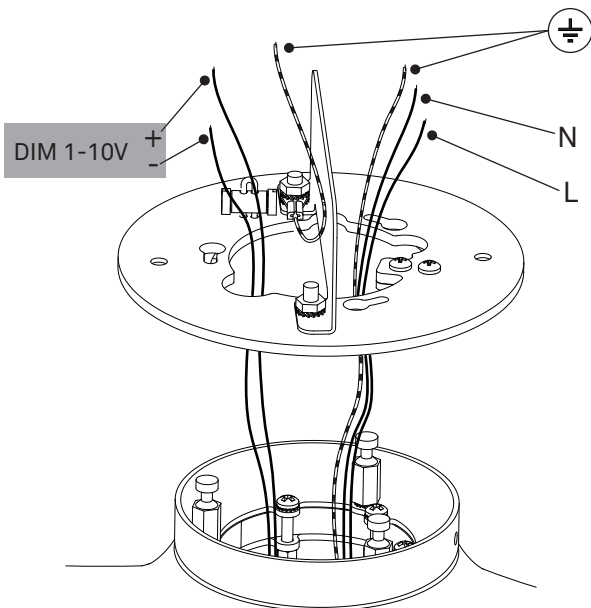
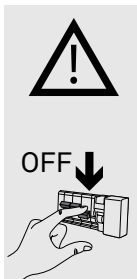

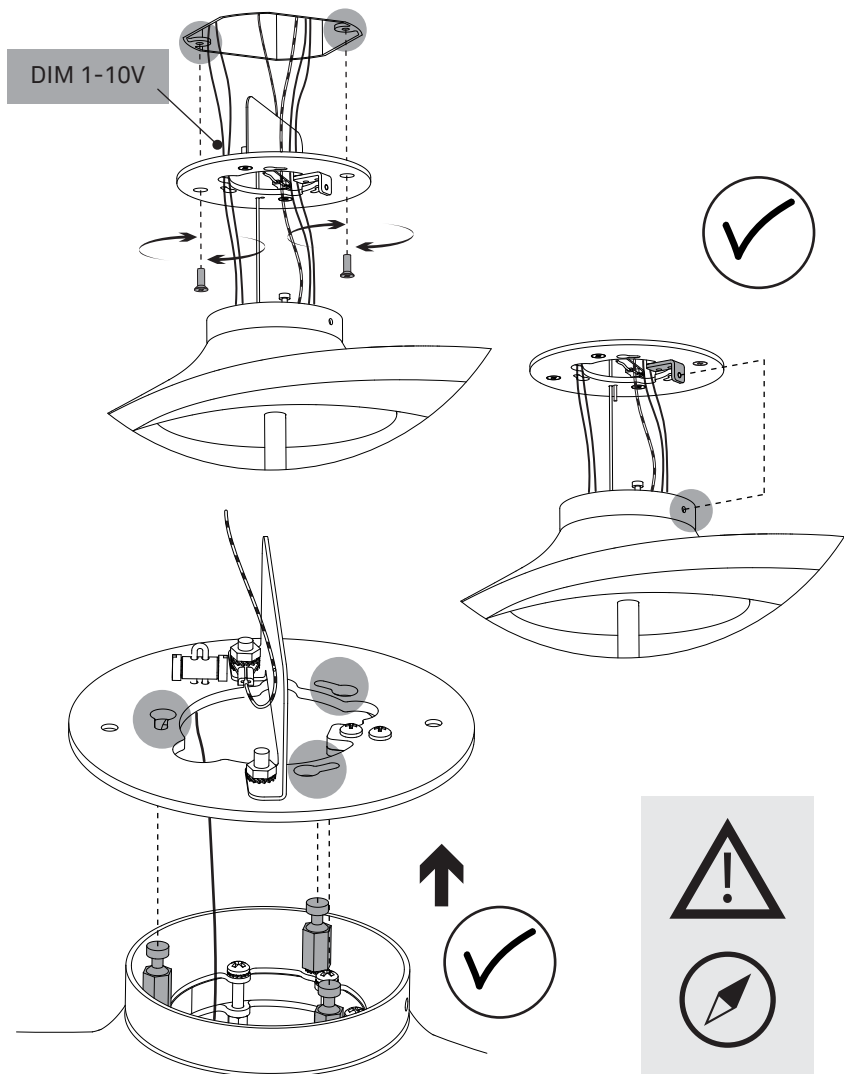

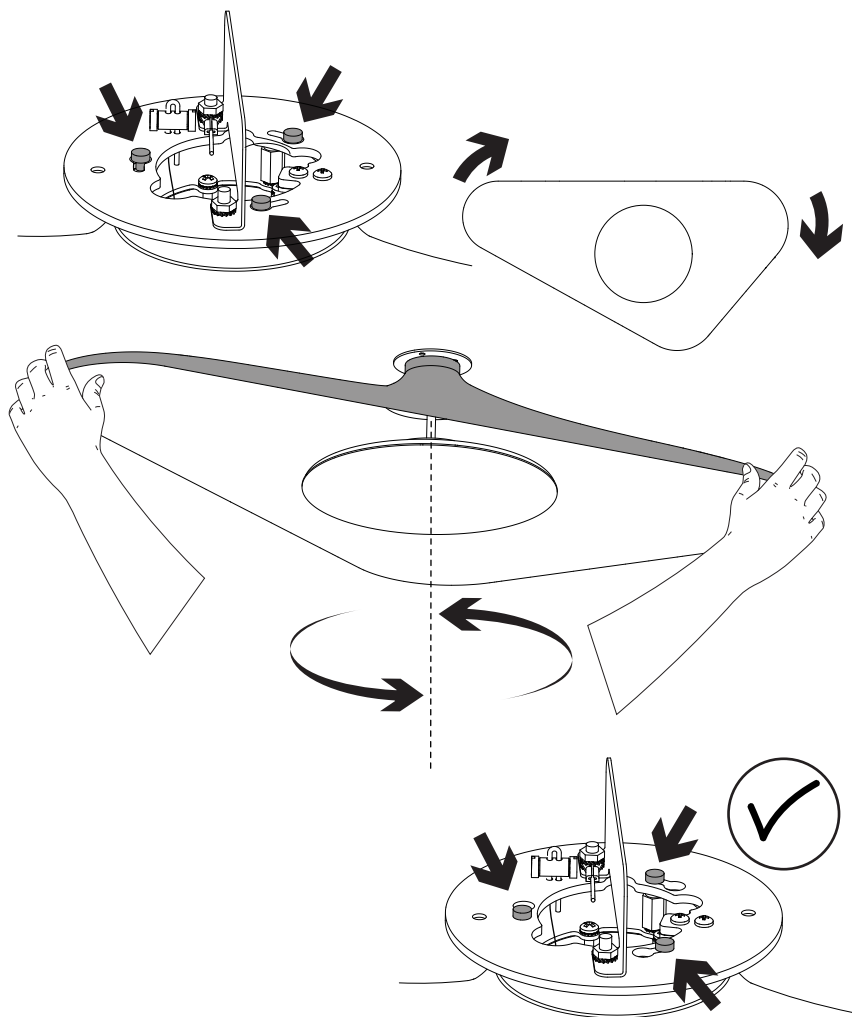

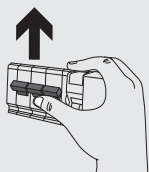
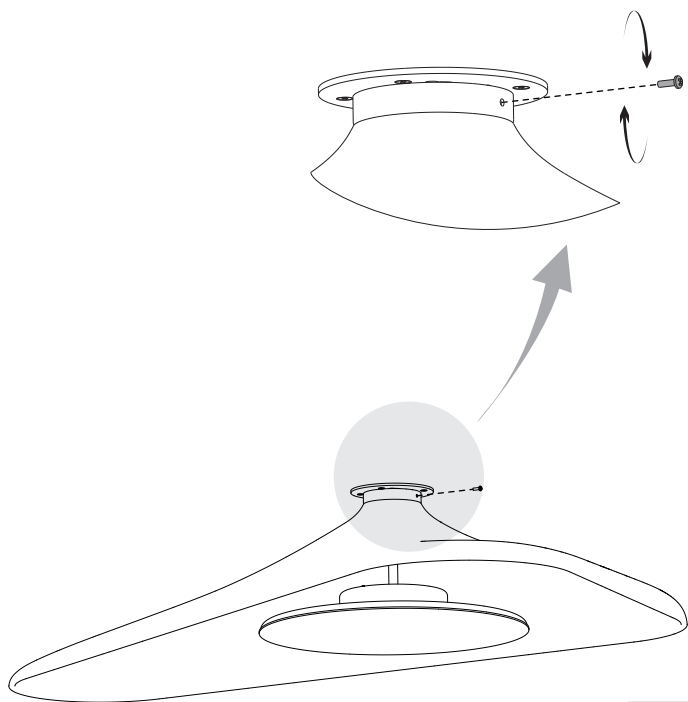

1

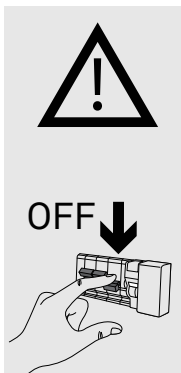
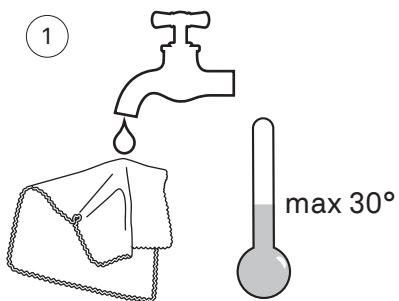

2

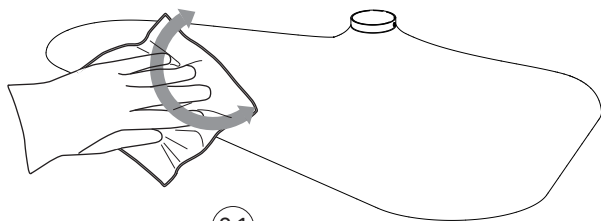

3.2

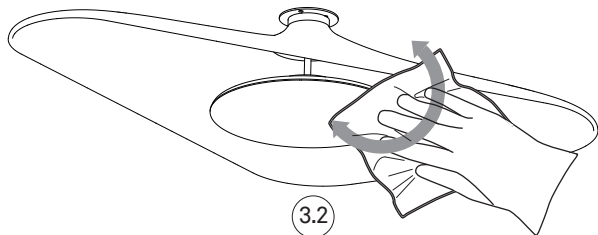



www.luceplan.com

D890IA102