

LITA

design David Dolcini

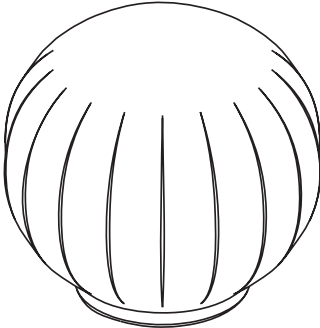
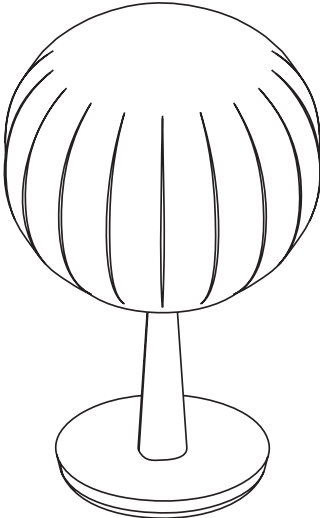

**LUCE
PLAN**

D92V30

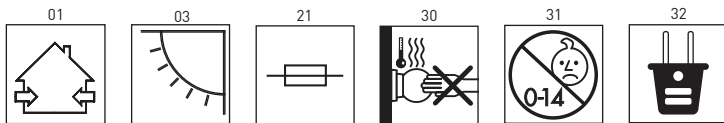

D92=30

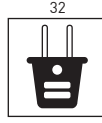
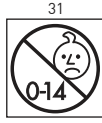
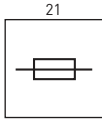
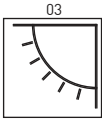
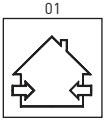

D92V30+D92/3

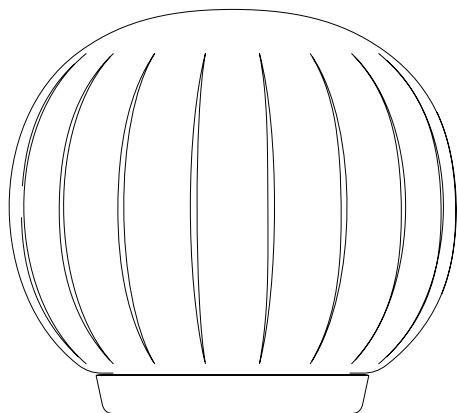

30 cm

11.8"

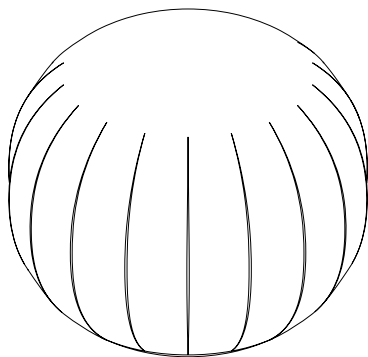

x1

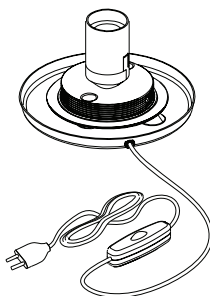

x1

kg 2,2 kg

lb 4.8 lb



MAX
15W
LED
E26

1

D92V30

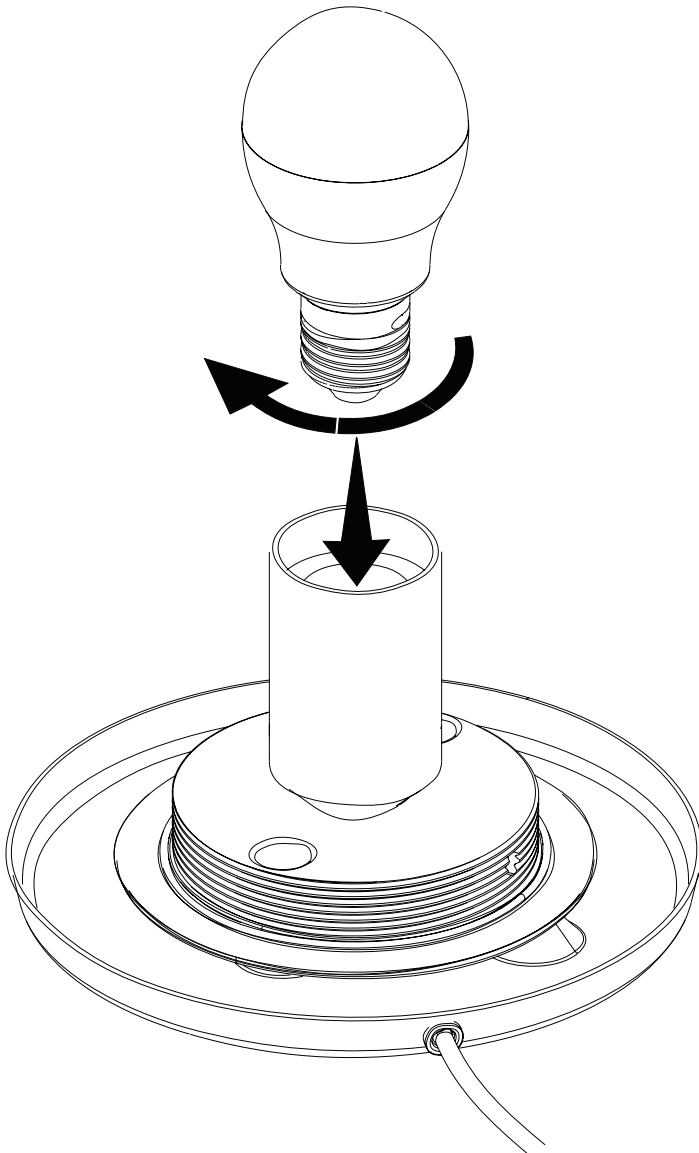

2

D92V30

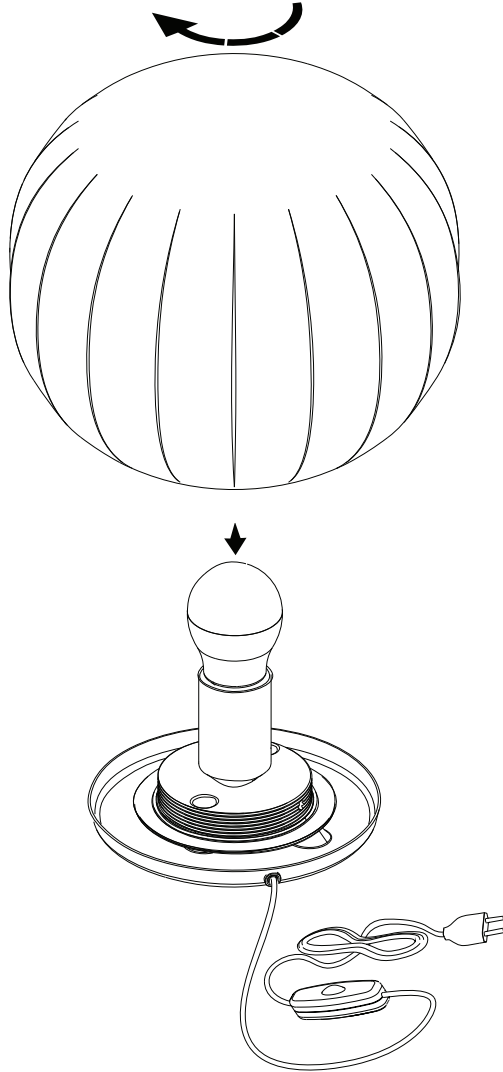

D92=30+D92/3

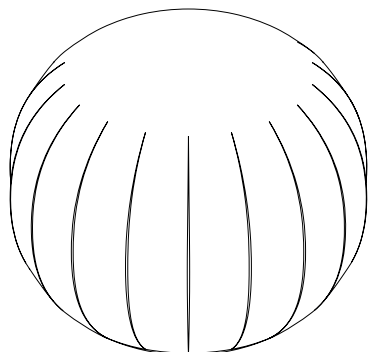
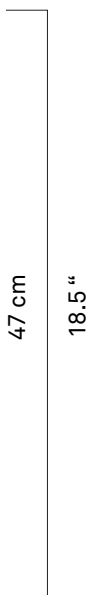
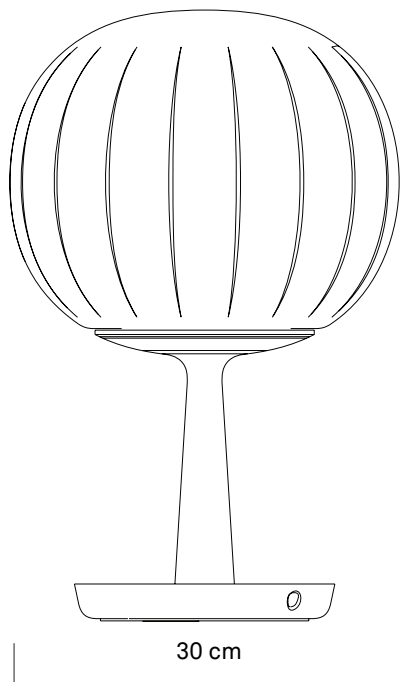

x1

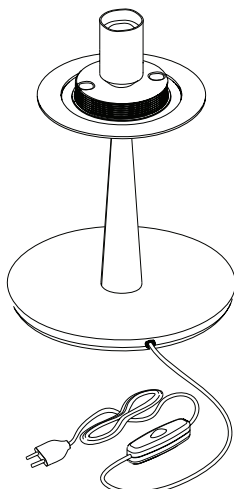

x1

kg 3,0 kg

lb 6.6 lb



MAX
16W
LED
E26



MAX
70W
E26

1

D92=18

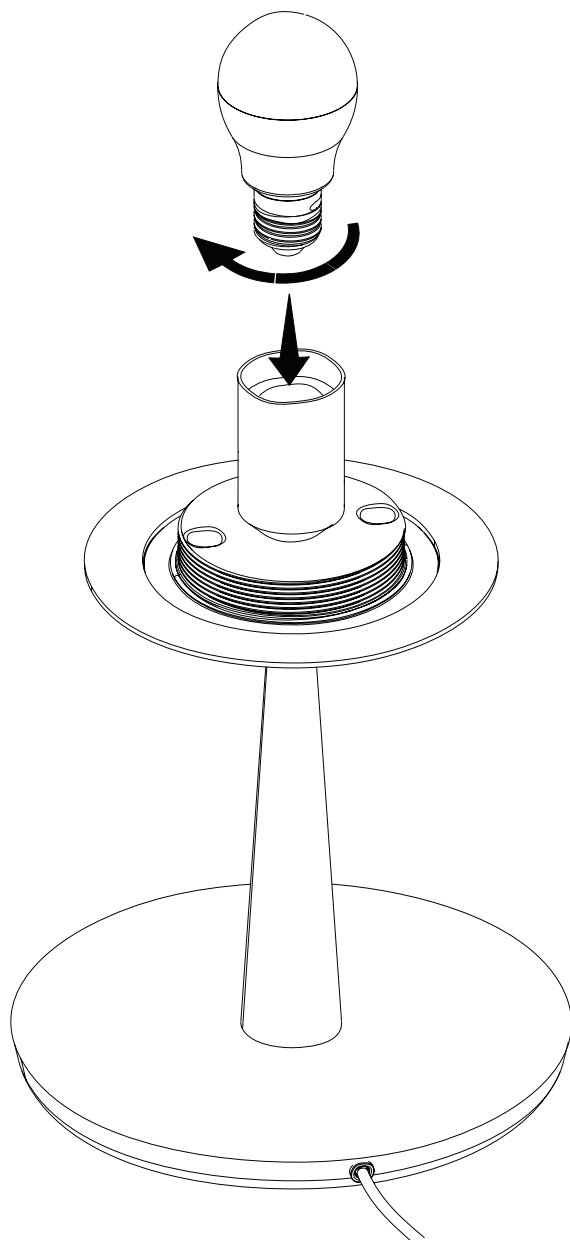

2

D92= 30

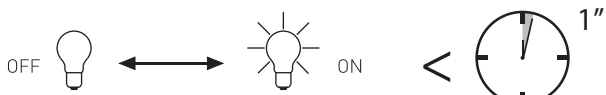
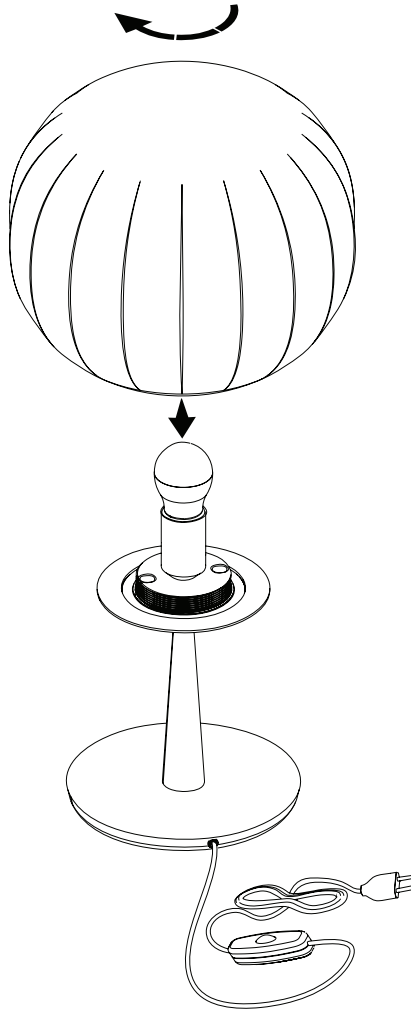

3

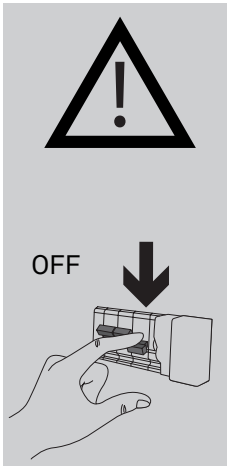

1.

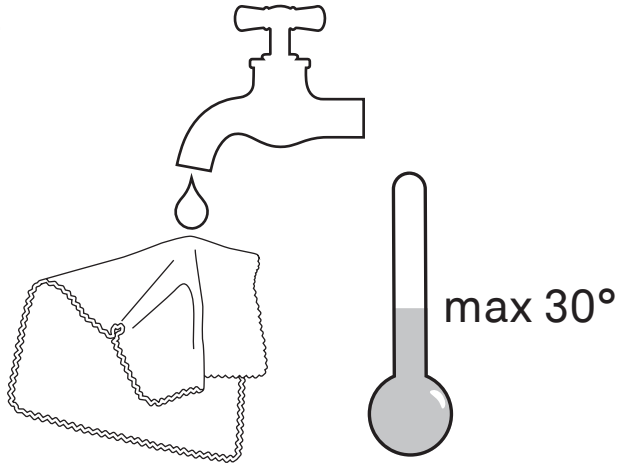

2.

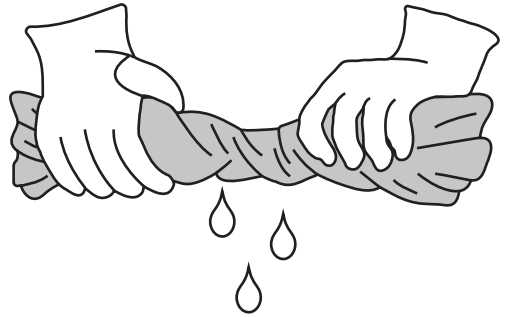

3.





www.luceplan.com

D920I0103