

AJ Eklipta 8.7" LED

Design Arne Jacobsen

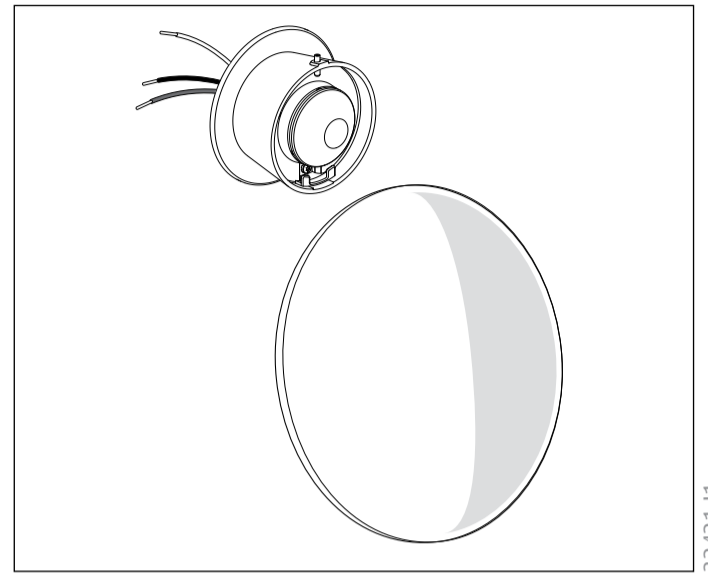
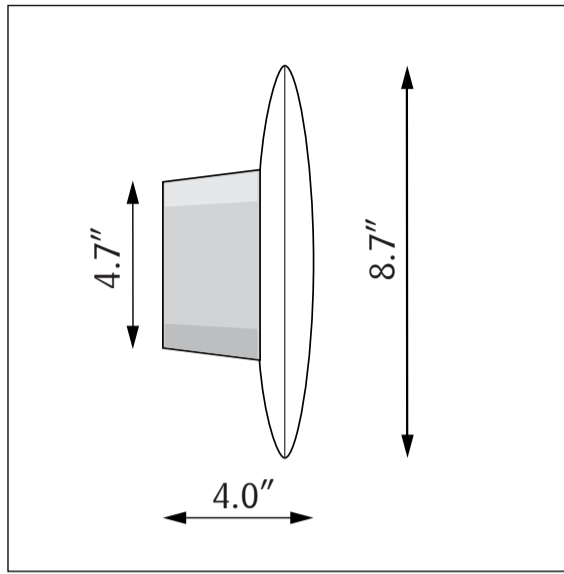
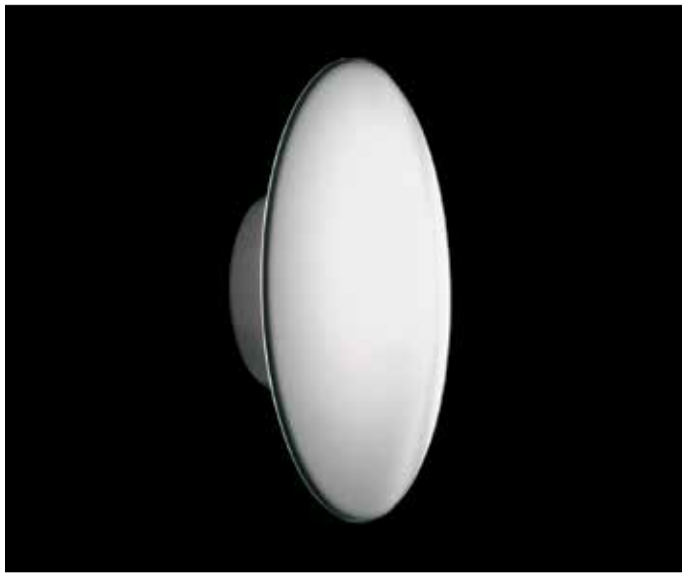

32421-11

Light source	Voltage	Weight	Electric shock protection	Ingress protection
LED	MAX 120V	2.64 Lbs	Cl. I	IP 20, wet location

Recommended cleaning substances:

Wipe off dust with a dry, soft cloth. Remove greasy spots etc. with a soft cloth dampened in lukewarm water (<122° F/ 50° C) with a mild detergent.

Mouth-blown glass in specific: Must be cleaned in cold condition. All water must be evaporated before the lamp is lit again. The glassware in this luminaire is handcrafted. To ensure the intended lighting comfort, our glassware is blown. The process may generate air bubbles in the glass, just as its thickness may vary.

Warning: Scouring powder and similar substances will scratch surfaces.

All installation is subject to local code and jurisdiction. Consult a qualified electrician to ensure correct branch circuit conductor.

The installer must ensure that the ceiling can support the luminaire's weight. The installer must if necessary reinforce the ceiling structure by adequate means.



Due to possibility of personal injury or property damage, always contact a qualified electrician for servicing or repair of this fixture. To avoid risk of electrical shock, personal injury, or death, disconnect power to fixture before servicing.

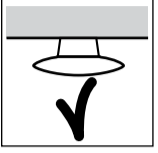
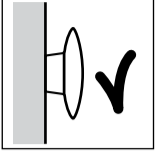
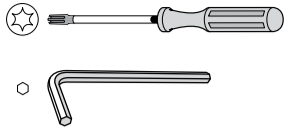
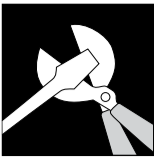

x3

White to Neutral
Black to Line
Green to Ground

! For wet locations!
• Apply silicone seal on the back of the luminaire housing

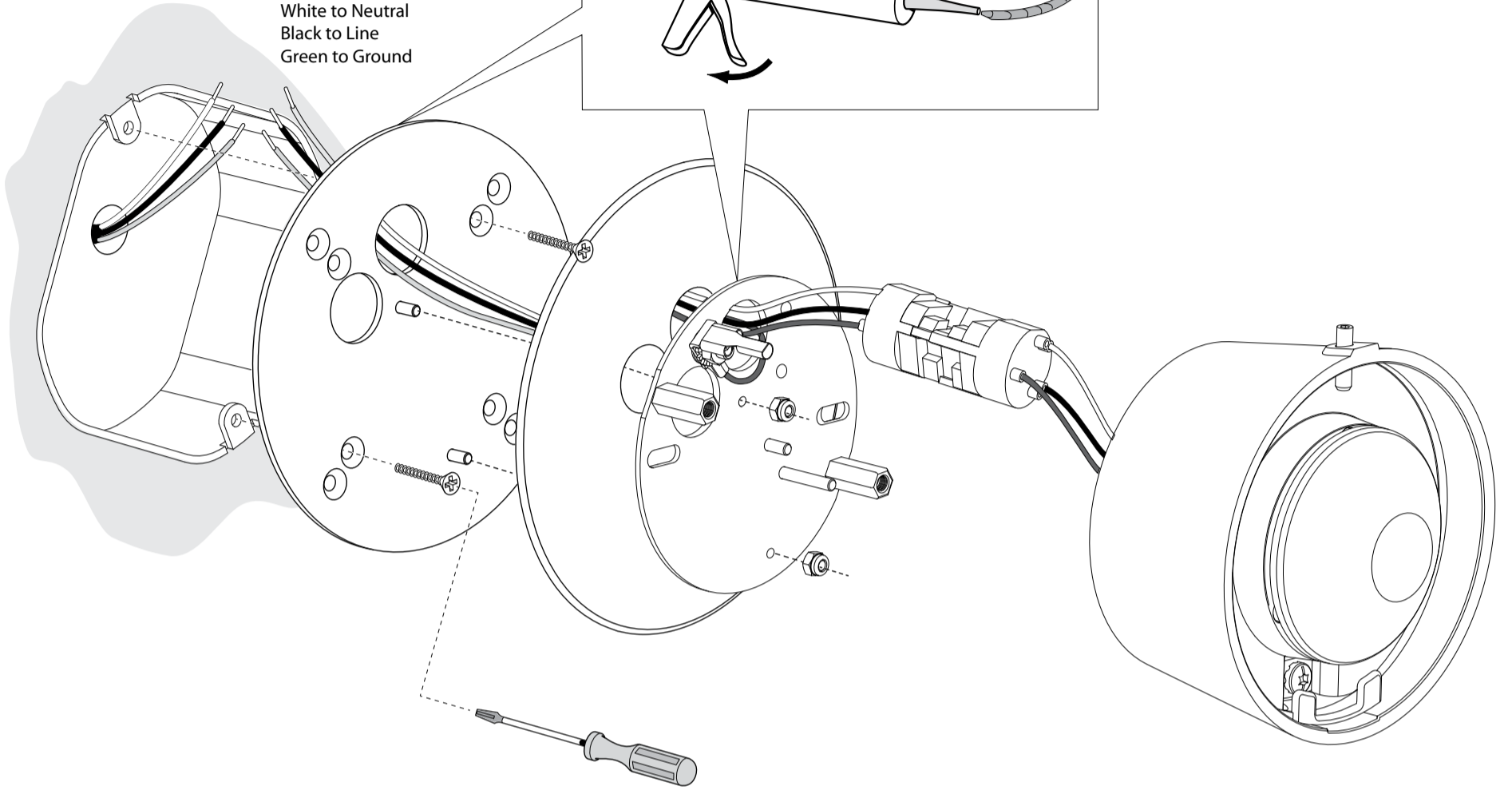
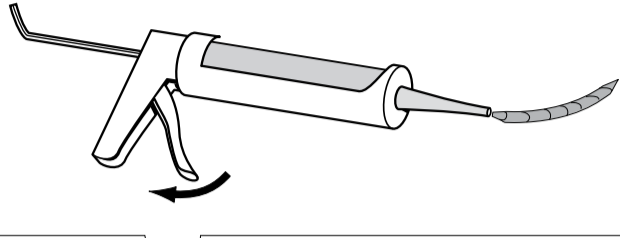

2mm

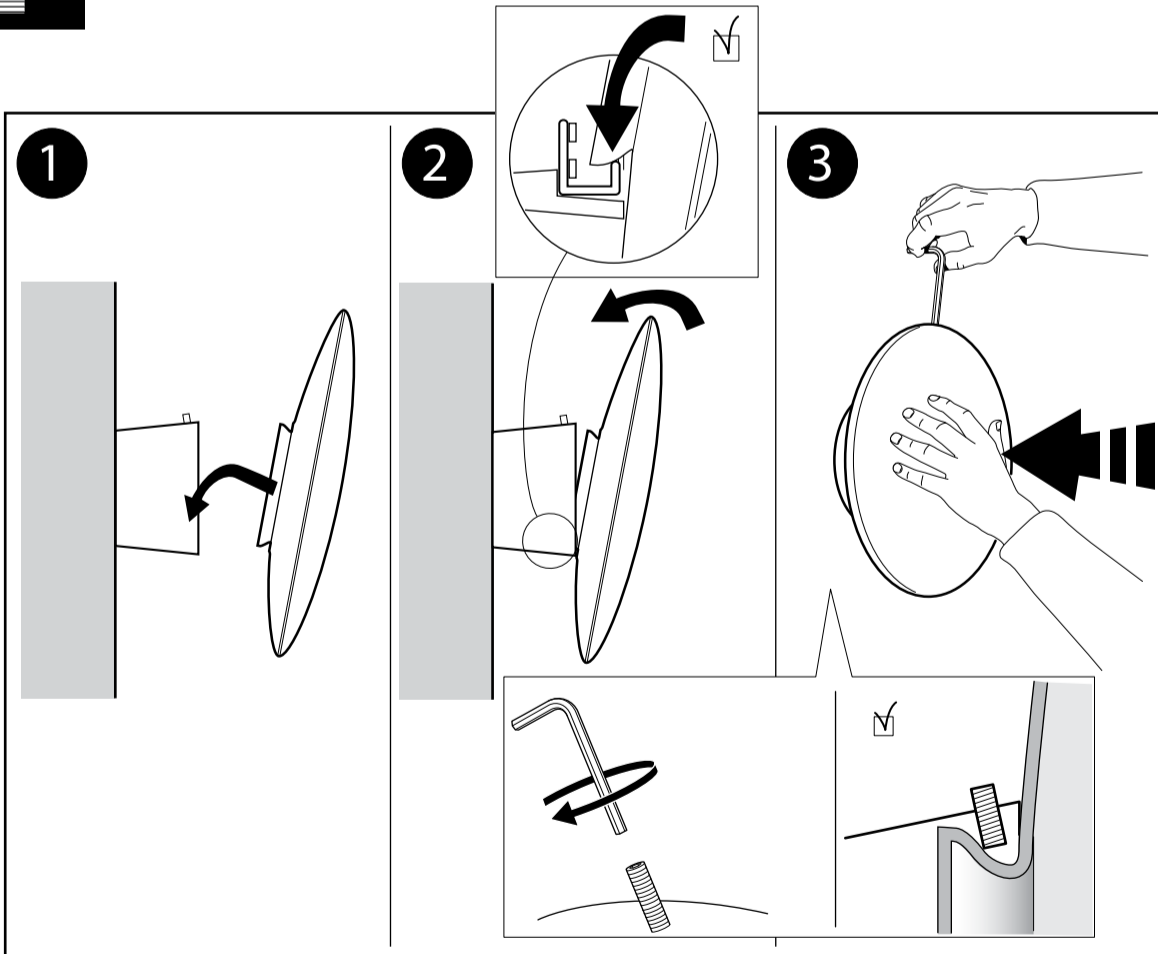

Press

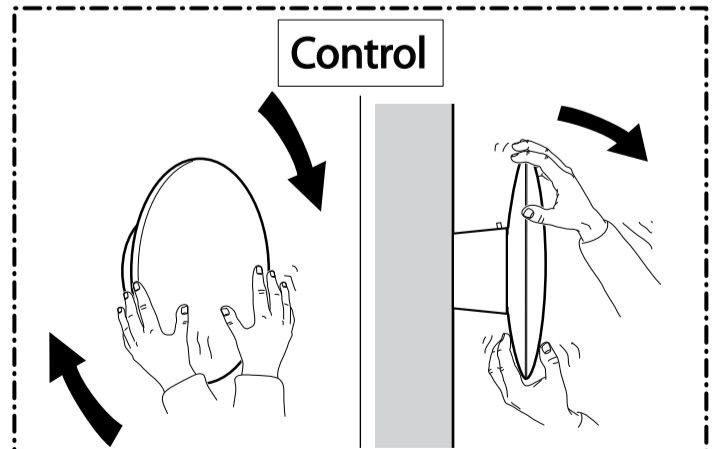

Check that the glass is held securely in place