

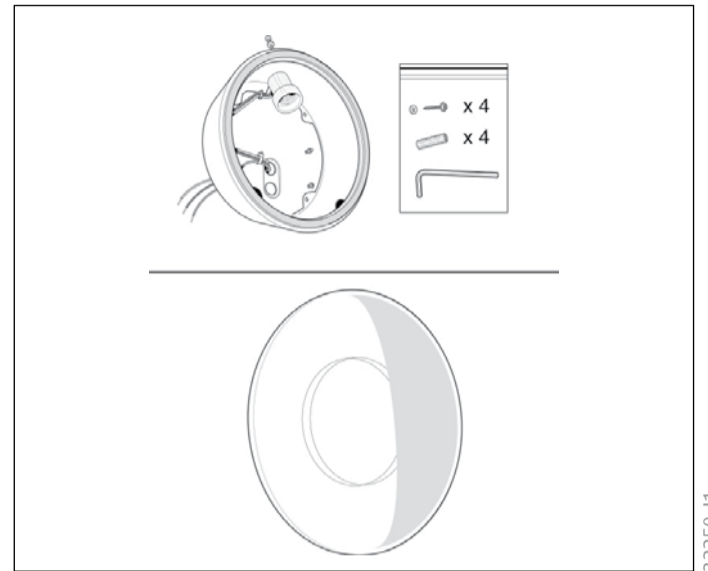

AJ Eklipta 13.7"

Design Arne Jacobsen

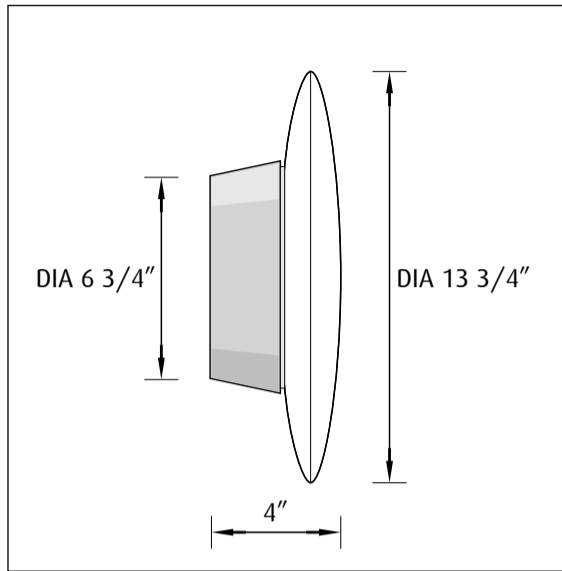
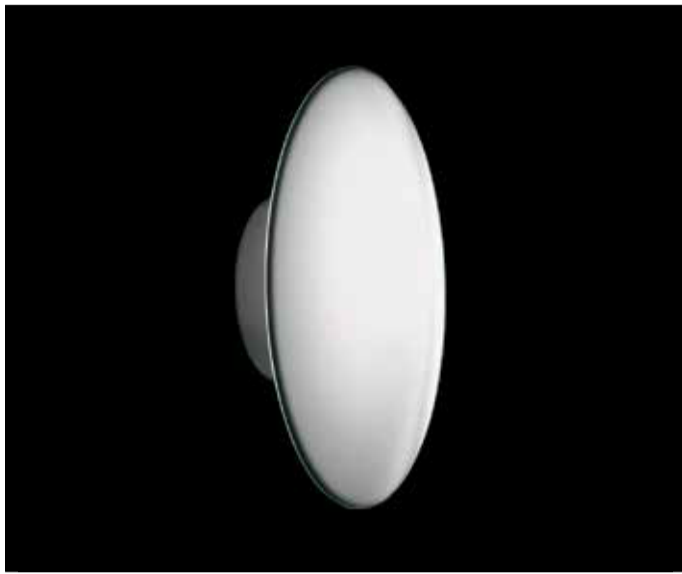

Light source	Voltage	Weight	Electric shock protection	Ingress protection
1/60W/A-19/ IF Medium 	120V	1.6 Lbs	Cl. I, Grounded	IP 20, Wet location

Recommended cleaning substances:

Wipe off dust with a dry, soft cloth. Remove greasy spots etc. with a soft cloth dampened in lukewarm water (<122° F/ 50° C) with a mild detergent.

Mouth-blown glass in specific: Must be cleaned in cold condition. All water must be evaporated before the lamp is lit again. The glassware in this luminaire is handcrafted. To ensure the intended lighting comfort, our glassware is blown. The process may generate air bubbles in the glass, just as its thickness may vary.

Warning: Scouring powder and similar substances will scratch surfaces.

All installation is subject to local code and jurisdiction. Consult a qualified electrician to ensure correct branch circuit conductor. The installer must ensure that the ceiling can support the luminaire's weight. The installer must if necessary reinforce the ceiling structure by adequate means.



Louis Poulsen A/S disclaims any liability if a half mirror light bulb is used. This type of light source reflects the heat and may damage/melt parts of the fixture.



3 x 4

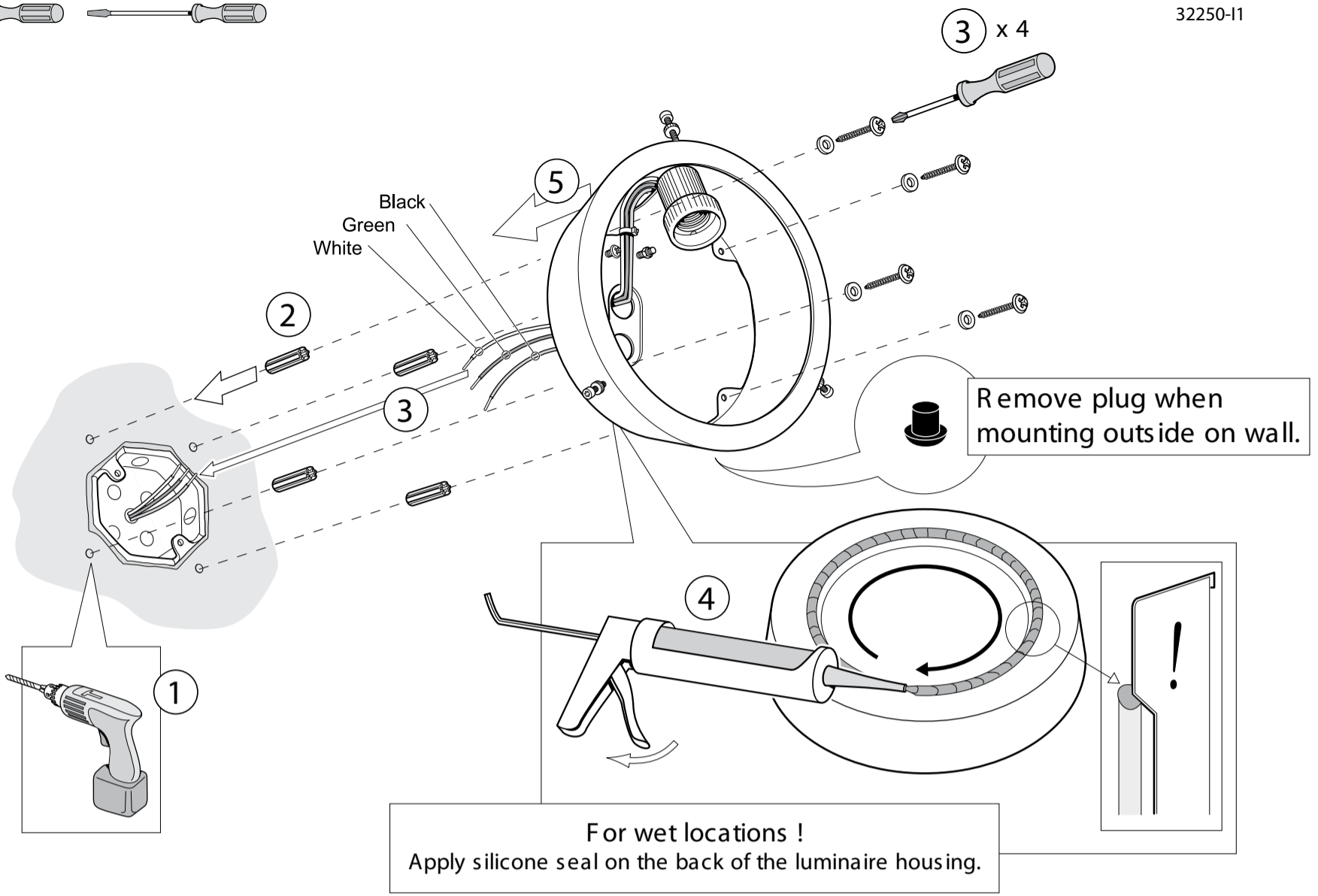
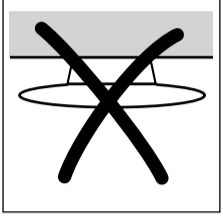
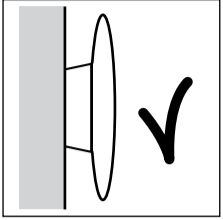

3mm

