

INSTALLATION INSTRUCTION
1" LEDme Mini Recessed - New Construction
 HR-LED231R, HR-LED232R, HR-271R, HR-272R

WAC LIGHTING
 Responsible Lighting®

SAFETY INSTRUCTION

To reduce the risk of fire, electrical shock and injuries to persons:

- Turn off power at main switch prior to installation.
- Use only with Class 2 Power supplies unit.
- Contact Manufacturer for LED replacement.
- Contact customer service ,better to use the recommended Class 2 power supplies unit.

MOUNTING AND WIRING:

1. Cut a 2 1/2" diameter hole on the ceiling.
2. Feed the fixture wires through the hole, and connect to wires from the Power Supply with connector.
3. Compress the springs on either side of the fixture and insert into the ceiling until the trim ring is flush to the ceiling.

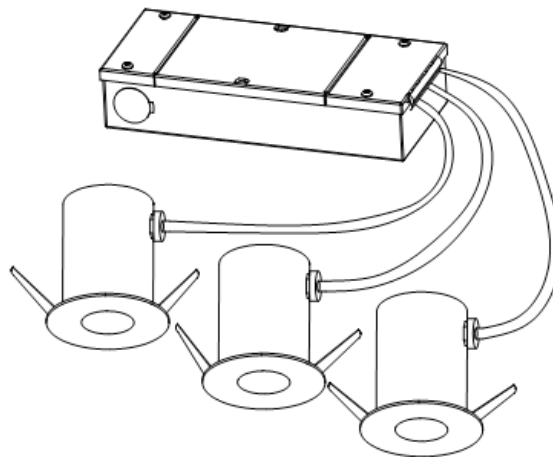
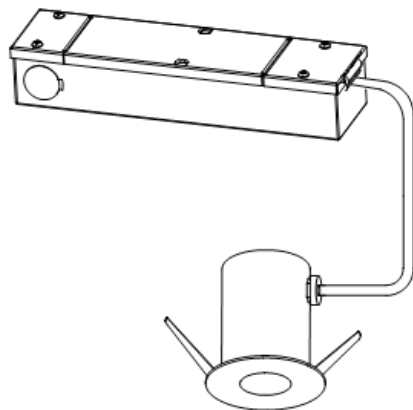
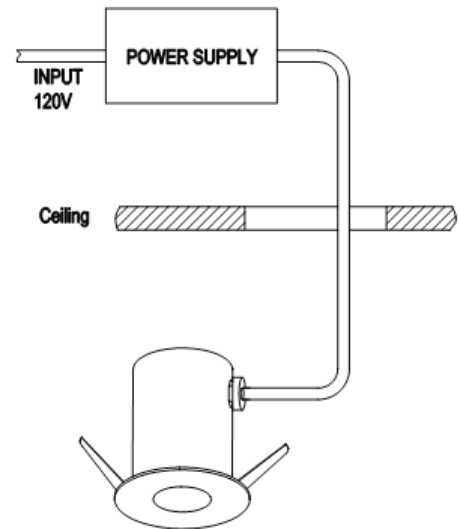

INPUT 120VAC 60Hz

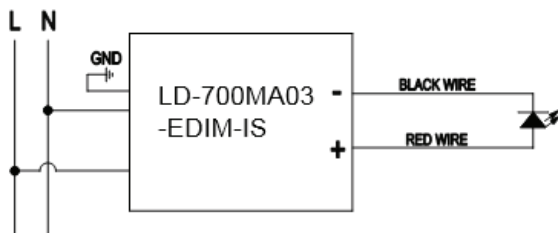

INPUT 120VAC 60Hz

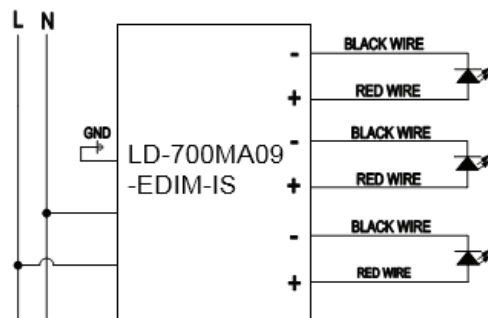

WAC Lighting
 www.waclighting.com
 Phone (800) 526.2588 • Fax (800) 526.2585

Headquarters/Eastern Distribution Center
 44 Harbor Park Drive • Port Washington, NY 11050
 Phone (516) 515.5000 • Fax (516) 515.5050

Western Distribution Center
 1750 Archibald Ave • Ontario, CA 91761
 Phone (800) 526.2588 • Fax (800) 526.2585

INSTALLATION INSTRUCTION

LEDme® Class 2 Electronic Drivers

LD-700MA03-EDIM-IS

WAC LIGHTING
Responsible Lighting®

SAFETY INSTRUCTION

To reduce the risk of fire, electric shock or injury to persons:

- Always turn off power at main switch prior to installation.
- System intended for installation by a qualified electrician, in accordance with NEC and local regulations. Consult with local inspector to assure compliance.
- For use with LED loads.

Model	LD-700MA03-EDIM-IS
Input Voltage	120V ac,60Hz
Input Current	Max 0.04A
OUTPUT CURRENT	700mA
Port Output Voltage	2-4V DC
Port Load	1PC 1x3W LED Fixtures
Port Load Lead Wires	12-22AWG
Output Port	1 PCS

FEATURES:

- 700mA constant current for LED's optimized and stable performance.
- Capable of supplying power to a single LED fixture.
- Special circuit design to protect LED from high voltage pulse. driver will automatically shut off if the fixtures are not properly wired. In this event, unplug and check the wiring and then plug it in again.
- For use with ELV dimmer.

INSTALLATION:

1. Loosen two cover screws and remove the cover. Inside there one sets of wiring terminals.
2. Push down one set of the wiring terminals and insert fixture's red wire into the "+" terminal and the black wire into the "-" terminal.
3. After connecting all the LED fixtures, secure the cover by tightening the two screws.
4. The product should be installed on the either internal or external surface of any indoor construction.

MOUNTING INSTRUCTIONS

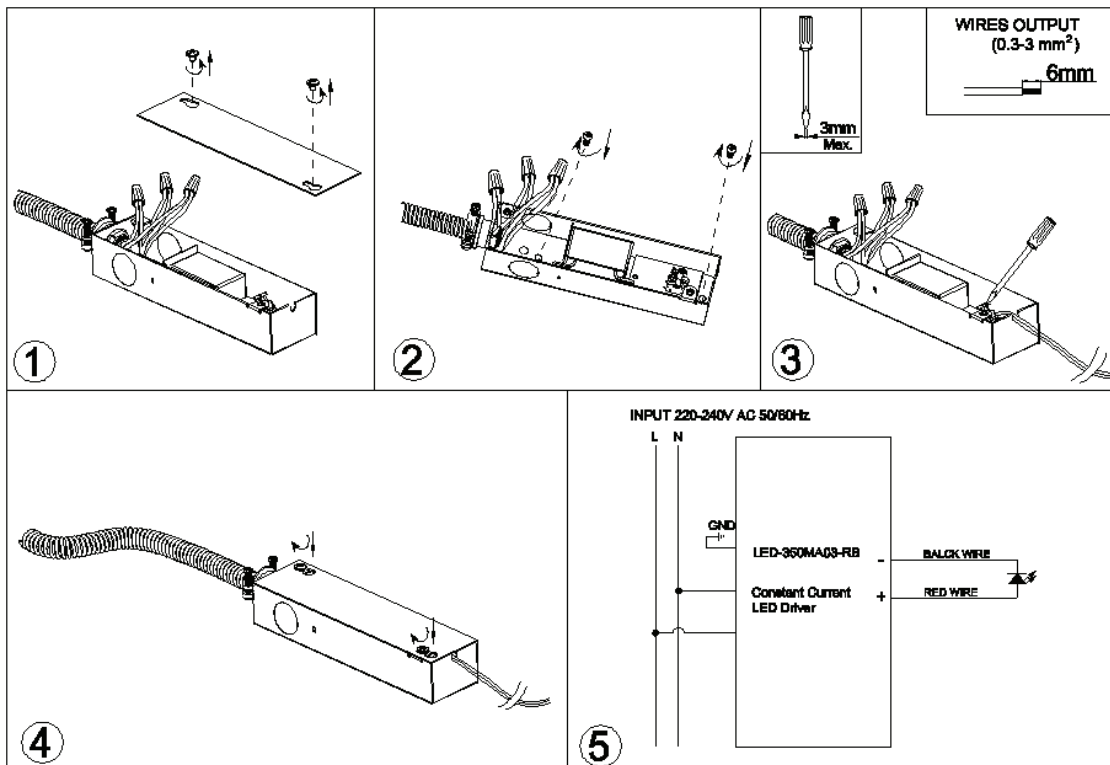

WAC Lighting
www.waclighting.com
Phone (800) 526.2588 • Fax (800) 526.2585

Headquarters/Eastern Distribution Center
44 Harbor Park Drive • Port Washington, NY 11050
Phone (516) 515.5000 • Fax (516) 515.5050

Western Distribution Center
1750 Archibald Ave • Ontario, CA 91761
Phone (800) 526.2588 • Fax (800) 526.2585

INSTALLATION INSTRUCTION

LEDme® Class 2 Electronic Drivers

LD-700MA09-EDIM-IS

WAC LIGHTING
Responsible Lighting®

SAFETY INSTRUCTION

To reduce the risk of fire, electric shock or injury to persons:

- Always turn off power at main switch prior to installation.
- System intended for installation by a qualified electrician, in accordance with NEC and local regulations. Consult with local inspector to assure compliance.
- For use with LED loads.

Model	LD-700MA09-EDIM-IS
Input Voltage	120Vac,60Hz
Input Current	Max 0.1A
Output Current	700mA
Each Port Output Voltage	2-4V DC
Each Port Load	1-3PCS 1x3W LED Fixtures
Each Port Load Lead Wires	12-22AWG
Output Port	3 PCS

FEATURES:

- 700mA Constant Current for LED's optimized and stable performance.
- Capable of supplying power to a single LED fixture, or more LED fixtures at once.
- Special circuit design to protect LED from high voltage pulse. Driver will automatically shut off if the fixtures are not properly wired. In this event, unplug and check the wiring and then plug it in again.
- For use with ELV dimmer.

INSTALLATION:

1. Loosen two cover screws and remove the cover. Inside there four separate sets of wiring terminals.
2. Push down one set of the wiring terminals and insert fixture's red wire into the "+" terminal and the black wire into the "-" terminal.
3. After connecting all the LED fixtures, secure the cover by tightening the two screws.
4. The product should be installed on the either internal or external surface of any indoor construction.

MOUNTING INSTRUCTIONS

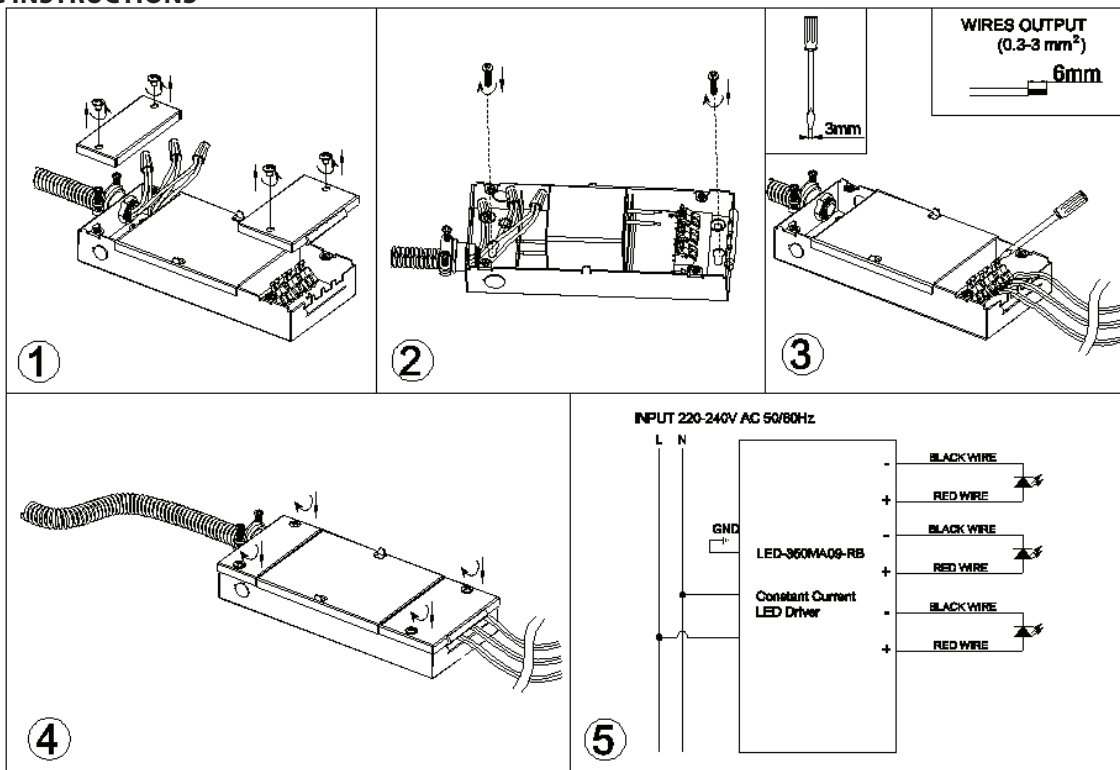

WAC Lighting
www.waclighting.com
Phone (800) 526.2588 • Fax (800) 526.2585

Headquarters/Eastern Distribution Center
44 Harbor Park Drive • Port Washington, NY 11050
Phone (516) 515.5000 • Fax (516) 515.5050

Western Distribution Center
1750 Archibald Ave • Ontario, CA 91761
Phone (800) 526.2588 • Fax (800) 526.2585