

LED Wall Sconce

WS24348

INSTALLATION SHEET

START FROM HERE

- Make sure power is completely off at the fuse box.
- Have your fixture installed by a qualified licensed electrician
- Prepare everything in a clear area.
- Wear gloves at all times during this installation.
- Read instructions carefully before you start assembly.
- Keep this instruction sheet for future reference.

Technical Support: 1-855-855-8926

Please Note:

- This Kuzco LED fixture comes with pre-wired LED module(s).
- Unless instructed to do so, please do not touch any part of the LED module(s) as any unnecessary contact with the module could cause permanent damage.
- For dimming, an ELV (Electronic Low Voltage) type of dimmer is required.

- 1.** Remove the fixture from its original packaging. Remove the mounting plate (1c) from within the fixture (2b) by removing the screws (2a). Pull out the mounting plate (1c) from within the fixture (2b) and attach to the electrical junction box (1a) using the two screws (1d) provided in the hardware package. Make sure to reinforce the wood behind the drywall for extra support and use the wood screws or anchors (1e,1f) to secure the mounting plate (1c) to the wall.
- 2.** Connect all wiring with the provided marrettes (1b) (white to white "N", black to black "L", ground to ground "G"). Attach the fixture (2b) to the mounting plate (1c) and secure with screws (2a).
- 3.** You have now completed the installation of your fixture, do enjoy.

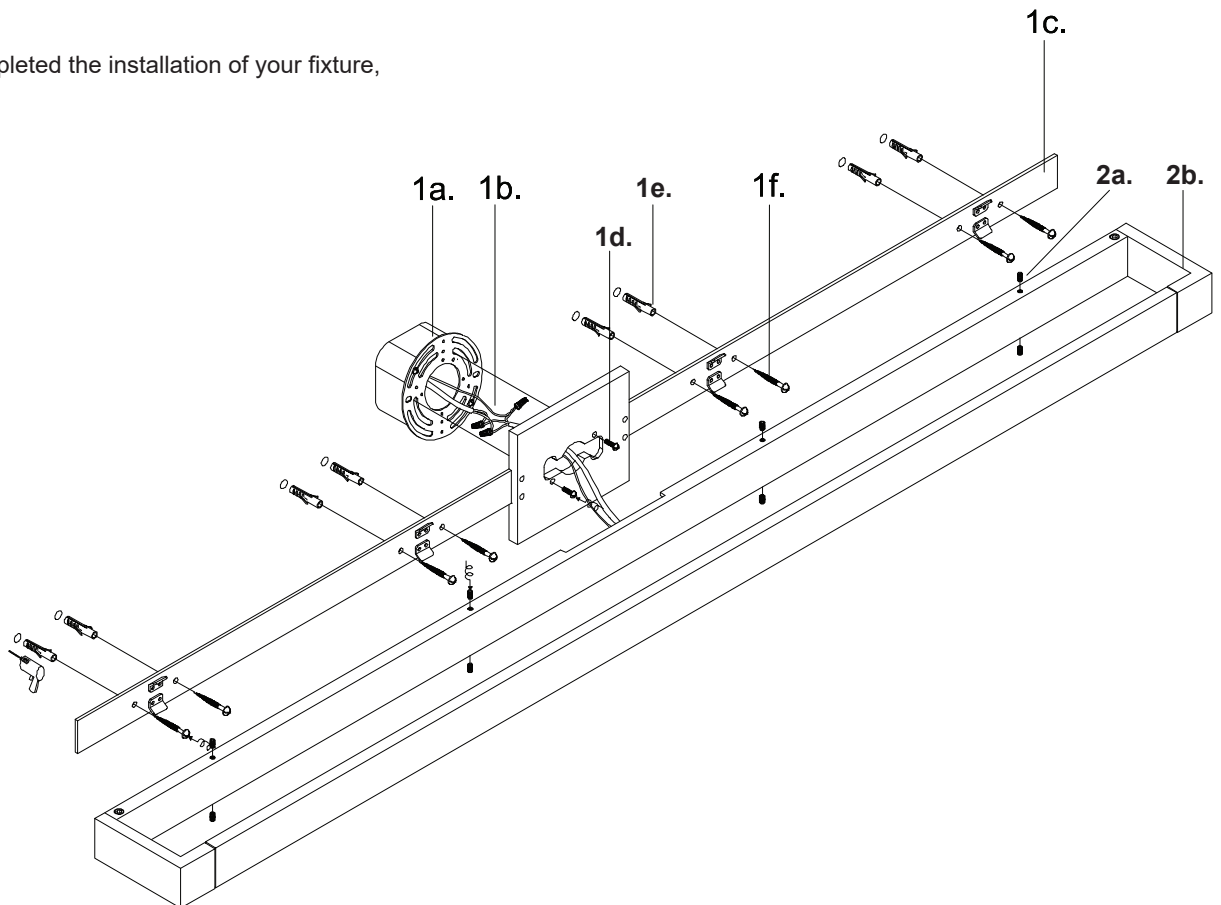

KUZCO

19054 28th Avenue Surrey, BC Canada V3Z 6M3
T: 604 538 7162 TF: 1-855 85 KUZCO F: 604 538 7196
W: kuzcolighting.com
20181121