

LED Exterior Lamp

EL17614

INSTALLATION SHEET

START FROM HERE

- Prepare everything in a clear area.
- Read instructions carefully before you start assembly.
- Keep this instruction sheet for future reference.

Technical Support: 1-855-855-8926

Please Note:

- This Kuzco LED fixture comes with pre-wired LED module(s)
- Unless instructed, Do Not touch any part of the LED module(s) as any unnecessary contact with the module could cause permanent damage
- Touch Switch Dimmer
- 120V input
- Please refer to the local regulation regarding proper disposal of batteries

USE AS DIRECTED

This product served exclusively lighting purposed and may:

- Not be exposed to strong mechanical loads or to strong contamination
- Only be installed and operated after a condition inspection if the product is dirty or has been moistened through storage

INSTRUCTIONS

1. Before first using, please charge:

- **Charging with USB Charger:** insert charger into the outlet
- **Charging with Solar panel:** place fixture in direct sunlight

2. Touch on/off switch to turn on/off. Touch and hold switch to dim up or dim down the light

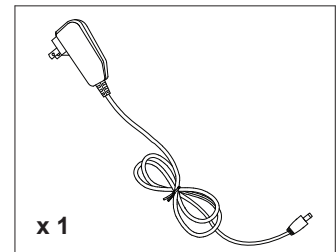
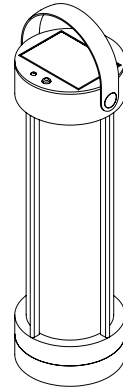

Optional (Transformer with Type C)

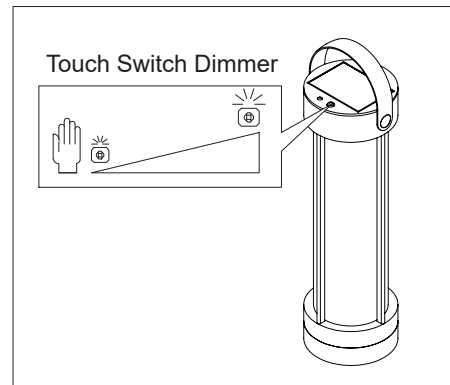
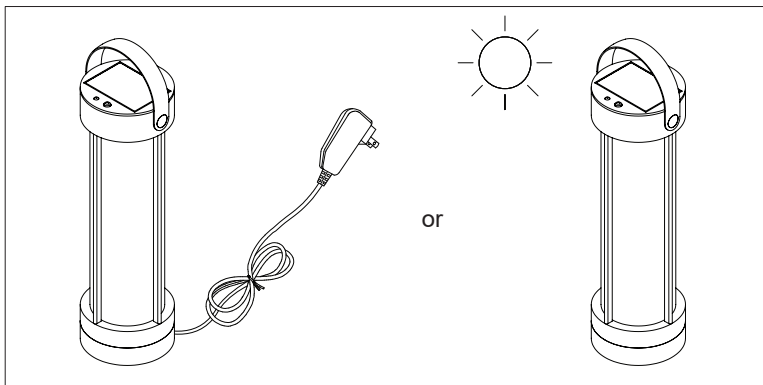

KUZCO

19054 28th Avenue Surrey, BC Canada V3Z 6M3
T: 604 538 7162 TF: 1-855 85 KUZCO F: 604 538 7196
W: kuzcolighting.com
20230619