

Incandescent Pendant

492116
INSTALLATION SHEET

START FROM HERE

- Make sure power is completely off at the fuse box.
- Have your fixture installed by a qualified licensed electrician
- Prepare everything in a clear area.
- Wear gloves at all times during this installation.
- Read instructions carefully before you start assembly.
- Keep this instruction sheet for future reference.

Please Note:

- 120V input

Technical Support: 1-855-855-8926

- 1.** Remove fixture from its original package
- 2.** Separate mounting plate (1c) from canopy (2a) by removing decorative nuts (2c)
- 3.** Align mounting plate screws (1d) to desired orientation, and then attach mounting plate (1c) to electrical junction box (1a) using junction box screws provided (1e) in hardware package
- 4.** To change fixture height, shorten or lengthen wire by removing screw (2b) from canopy (2a) and push or pull wire to your desired length. Secure screw (2b) in canopy (2a) to lock wire in place
- 5.** Make proper electrical connections (**black to hot "L"**, **white to neutral "N"**, **ground to "GND"**) with wire nuts (1b) provided in hardware package
- 6.** Align and insert mounting plate screws (1d) through holes on canopy (2a), secure with decorative nuts (2c)
- 7.** Insert bulb (4a) into fixture socket

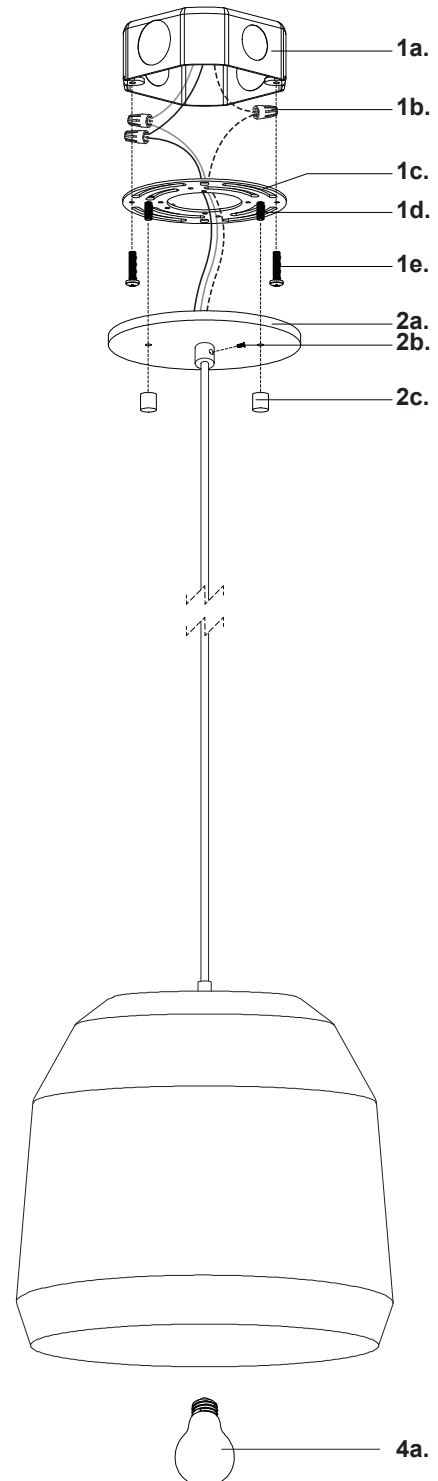

KUZCO

19054 28th Avenue Surrey, BC Canada V3Z 6M3
T: 604 538 7162 TF: 1-855 85 KUZCO F: 604 538 7196
W: kuzcolighting.com
20220913