

## LED Lamp Wall Sconce

# 601004-LED

## INSTALLATION SHEET

1. Remove the fixture from its original packaging. Remove the canopy mounting plate from within the canopy and attach it to the electrical junction box, using the two screws provided in the hardware package.
2. Push the canopy mounting screw through the center hole of the metal cover plate, then **(2a)** feed the electrical wires, from inside the electrical box, through the second hole in the metal cover plate. **(2b)** Push the canopy mounting screw through the center hole in the back of the canopy back plate until it is poking through, then **(2c)** feed the electrical wires through the second hole in the canopy back plate. Once this is complete you can **(2d)** screw on the mounting nut until tight, and **(2e)** secure the canopy back plate using the screws provided in the hardware package.
3. Attach the canopy to the canopy back plate, which is attached to the electrical junction box. First attach all wiring with the provided marrets (white to white "N", black to black "L", ground to ground "G"). Align the holes on the sides of the canopy to the holes on the canopy back plate. Once aligned, screw in the four screws provided to secure the canopy to the back plate.
4. Gently slide the glass cover into place over top of the canopy, while pushing the screws through the holes in the glass until the screws are poking through. **(4a)** Once this is complete you can screw on the decorative nuts to secure the glass to the fixture (do not over tighten).
5. You have now completed the installation of your fixture, please enjoy.

### START FROM HERE

- Make sure power is completely off at the fuse box.
- Have your fixture installed by a qualified licensed electrician
- Prepare everything in clear area.
- Wear gloves at all times during this installation.
- Read instructions carefully before you start assembly.
- Keep this instruction sheet for future reference.

**Technical Support:** 1-855-855-8926

#### Please Note:

- All Kuzco LED fixtures come with pre-wired LED module(s).
- Unless instructed to do so, please do not touch any part of the LED module(s) as any unnecessary contact with the module could cause permanent damage.
- For dimming, an ELV (Electronic Low Voltage) dimmer is required.

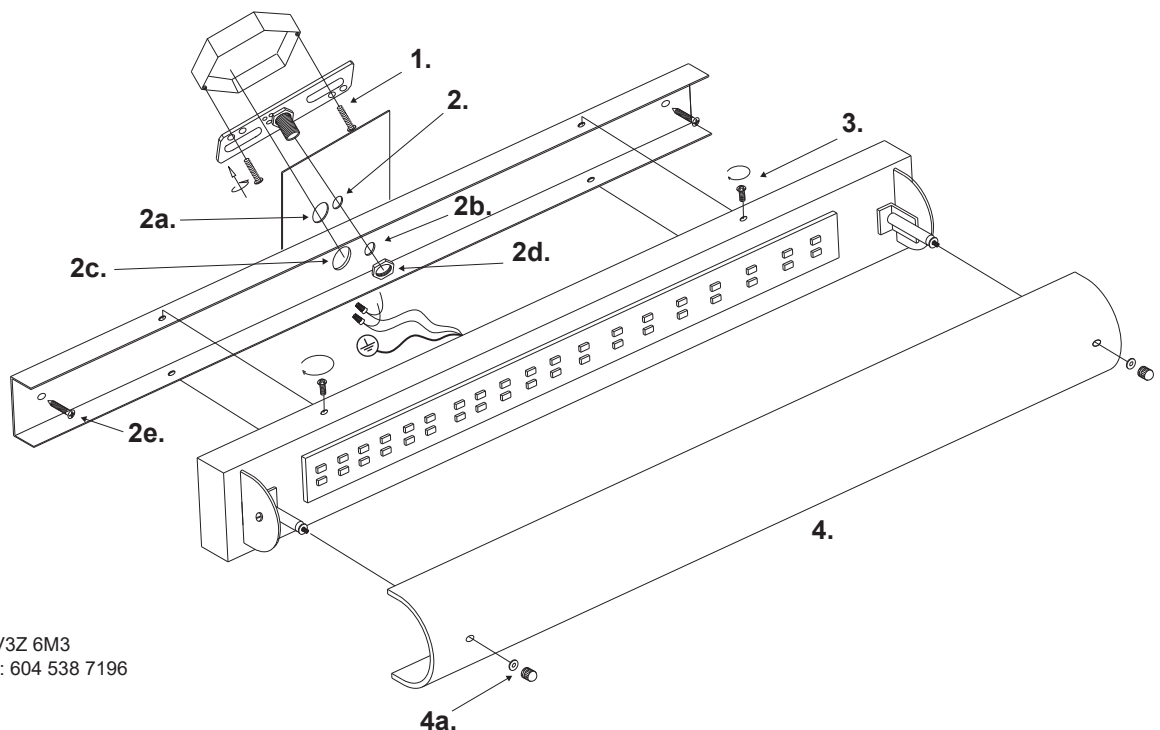

# KUZCO

19054 28th Avenue Surrey, BC Canada V3Z 6M3  
T: 604 538 7162 TF: 1-855 85 KUZCO F: 604 538 7196  
W: kuzcolighting.com  
20181127