

**MAGELLAN  
CH51818**  
CHANDELIERS

PROJECT



**DESCRIPTION**

Large-scale statement piece, multiple direct acrylic disc and a hollow core. Fine textured dark metallic frame

**SPECIFICATION DETAILS**

<b>Fixture Dimensions</b>	D17-3/4" x H18-1/2"
<b>Light Source</b>	LED with DC Driver
<b>Wattage</b>	100W
<b>Total Lumens</b>	8500lm
<b>Delivered Lumens</b>	5400lm*
<b>Voltage</b>	120V
<b>Color Temperature</b>	3000K
<b>CRI (Ra)</b>	90CRI
<b>Optional Color Temps</b>	2700K - 5000K Available, Minimum Order Quantities Apply
<b>LED Rated Life</b>	50,000 hours
<b>Dimming</b>	100% - 10%, TRIAC or ELV Dimmer (Not Included)
<b>Diffuser Details</b>	Frosted acrylic diffuser
<b>Adjustable</b>	Yes
<b>Rod Length</b>	46" Max (3x12" + 1x6" + 1x4")
<b>Wire Length</b>	60"
<b>Minimum Hang Height</b>	28"
<b>Sloped Ceiling Adaptable</b>	Yes, Up to 45 Degrees
<b>Location</b>	Dry
<b>Canopy Dimensions</b>	D9-1/2" x H2-1/4"
<b>Paint Finish</b>	BK02
<b>Finish Option(s)</b>	Black

\* For custom options, consult factory for details.

\* For warranty information, please visit [www.kuzcolighting.com/warranty](http://www.kuzcolighting.com/warranty)

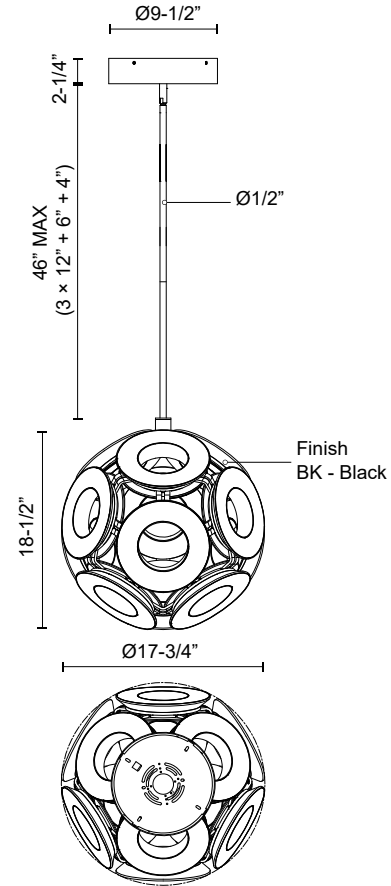

**KUZCO**

CANADA: 19054 28TH AVENUE - SURREY, BC V3Z 6M3  
USA: 3035 E. LONE MOUNTAIN ROAD - LAS VEGAS, NV 89081

[WWW.KUZCOLIGHTING.COM](http://WWW.KUZCOLIGHTING.COM)

© 2021 KUZCO LIGHTING. ALL RIGHTS RESERVED.

**COMMENT**

