

LED Flush Mount

FM44614

INSTALLATION SHEET

START FROM HERE

- Make sure **POWER** is **COMPLETELY OFF** at the fuse box
- Have your fixture installed by a qualified licensed electrician
- Prepare everything in a clear area
- Wear gloves at all time during this installation
- Read instructions carefully before you start assembly
- Keep this installation sheet for future reference

Please Note:

- This Kuzco LED fixture comes with pre-wired LED module(s)
- Unless instructed, Do Not touch any part of the LED module(s) as any unnecessary contact with the module could cause permanent damage
- Use ELV (Electronic Low Voltage) type of dimmer for dimming application
- 120V input

Technical Support: 1-855-855-8926

- 1.** Remove fixture from its original package
- 2.** Separate mounting plate (**1c**) from fixture (**2a**) by removing decorative nuts (**2c**)
- 3.** Align mounting plate screws (**1d**) to desired orientation, and then attach mounting plate (**1c**) to electrical junction box (**1a**) using junction box screws provided (**1e**) in hardware package
- 4.** Make proper electrical connections (**black to hot "L"**, **white to neutral "N"**, **ground to "GND"**) with wire nuts (**1b**) provided in hardware package
- 5.** Align and insert mounting plate screws (**1d**) through holes on fixture (**2a**), secure with decorative nuts (**2c**)
- 6.** Secure diffuser (**3a**) to fixture (**2a**) by threading clockwise

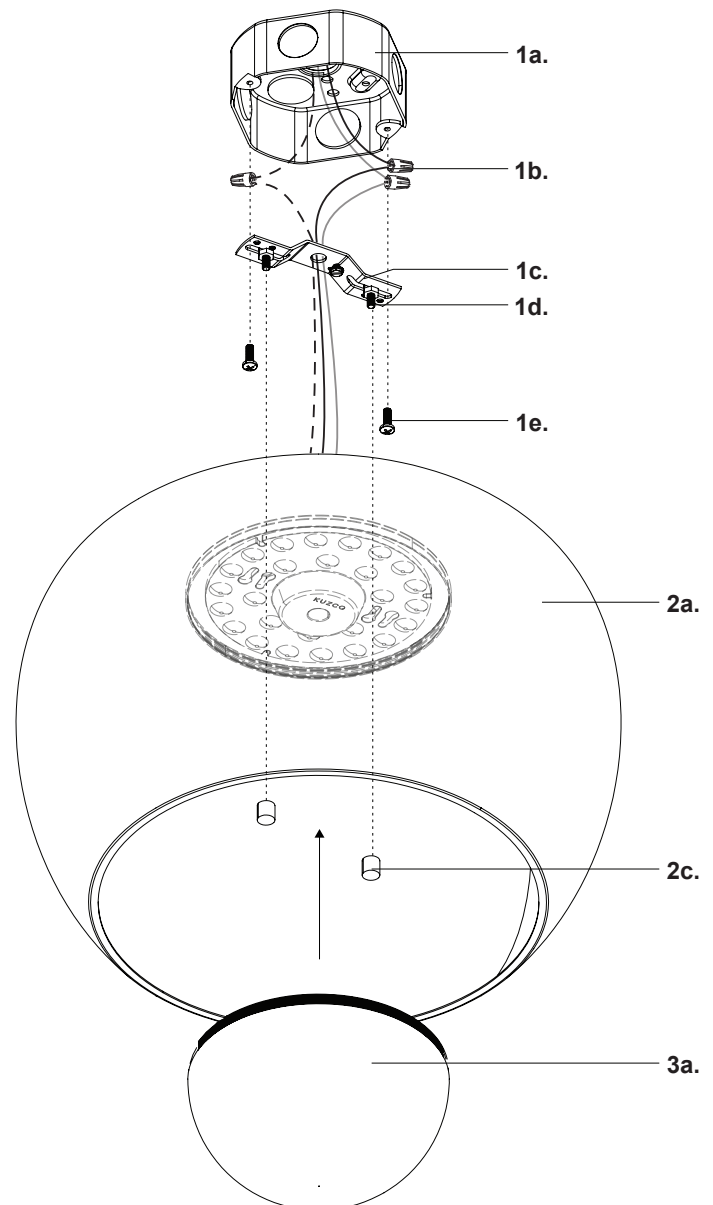

KUZCO

19054 28th Avenue Surrey, BC Canada V3Z 6M3
T: 604 538 7162 TF: 1-855 85 KUZCO F: 604 538 7196
W: kuzcolighting.com
20220615