

Ceiling LED Pendant

PD82724
INSTALLATION SHEET

START FROM HERE

- Make sure **POWER** is **COMPLETELY OFF** at the fuse box
- Have your fixture installed by a qualified licensed electrician
- Prepare everything in a clear area
- Wear gloves at all time during this installation
- Read instructions carefully before you start assembly
- Keep this installation sheet for future reference

Please Note:

- This Kuzco LED fixture comes with pre-wired LED module(s)
- Unless instructed, Do Not touch any part of the LED module(s) as any unnecessary contact with the module could cause permanent damage
- Use ELV (Electronic Low Voltage) or TRIAC type of dimmer for dimming application
- 120V input

Technical Support: 1-855-855-8926

- 1.** Remove fixture from its original package
- 2.** Separate mounting plate (1c) from canopy (2a) by removing canopy screws (2f)
- 3.** Attach mounting plate (1c) to electrical junction box (1a) using screws provided (1e) in hardware package
- 4.** To change fixture height, push and hold wire gripper (2g), slide wire to desired length and then release wire gripper (2g) to secure
- 5.** Secure mounting plate (1c) to mounting surface with anchors (1f) and wooden screws (1g)
- 6.** Make proper electrical connections (black to hot "L", white to neutral "N", ground to "GND") with wire nuts (1b) provided in hardware package
- 7.** Attach canopy (2a) to mounting plate (1c) with canopy screws (2f)
- 8.** Fine tune wire length if necessary, by push and hold wire gripper (2g) and then adjust wire to desired length

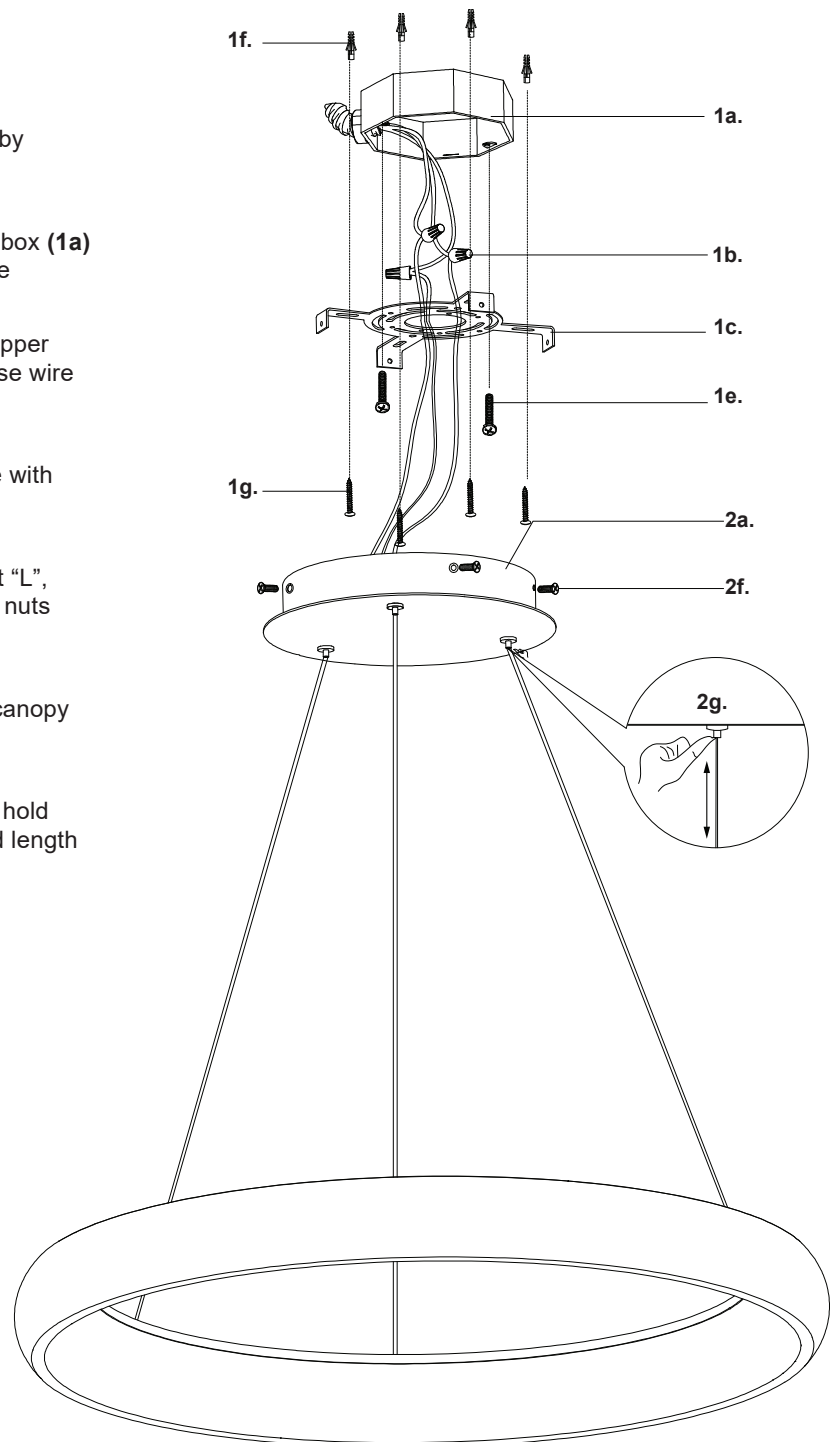

KUZCO

19054 28th Avenue Surrey, BC Canada V3Z 6M3
T: 604 538 7162 TF: 1-855 85 KUZCO F: 604 538 7196
W: kuzcolighting.com
20220323