

Ceiling LED Pendant

PD87736
INSTALLATION SHEET

START FROM HERE

- Make sure **POWER** is **COMPLETELY OFF** at the fuse box
- Have your fixture installed by a qualified licensed electrician
- Prepare everything in a clear area
- Wear gloves at all time during this installation
- Read instructions carefully before you start assembly
- Keep this installation sheet for future reference

Technical Support: 1-855-855-8926

Please Note:

- This Kuzco LED fixture comes with pre-wired LED module(s)
- Unless instructed, Do Not touch any part of the LED module(s) as any unnecessary contact with the module could cause permanent damage
- Use ELV (Electronic Low Voltage) or TRIAC type of dimmer for dimming application
- 120V input

- 1.** Remove fixture from its original package
- 2.** Separate mounting plate (1c) from canopy (2a) by removing canopy screws (2b)
- 3.** Attach mounting plate (1c) to electrical junction box (1a) using junction box screws provided (1e) in hardware package
- 4.** Secure mounting plate (1c) to mounting surface with anchors (1f) and screws (1g)
- 5.** To change fixture height, push and hold wire gripper (2g), slide wire to desired length and then release wire gripper (2g) to secure
- 6.** Make proper electrical connections (**black to hot "L"**, **white to neutral "N"**, **ground to "GND"**) with wire nuts (1b) provided in hardware package
- 7.** Attach canopy (2a) to mounting plate (1c) with canopy screws (2b)
- 8.** Fine tune wire length if necessary, by push and hold wire gripper (2g) and then adjust wire to desired length

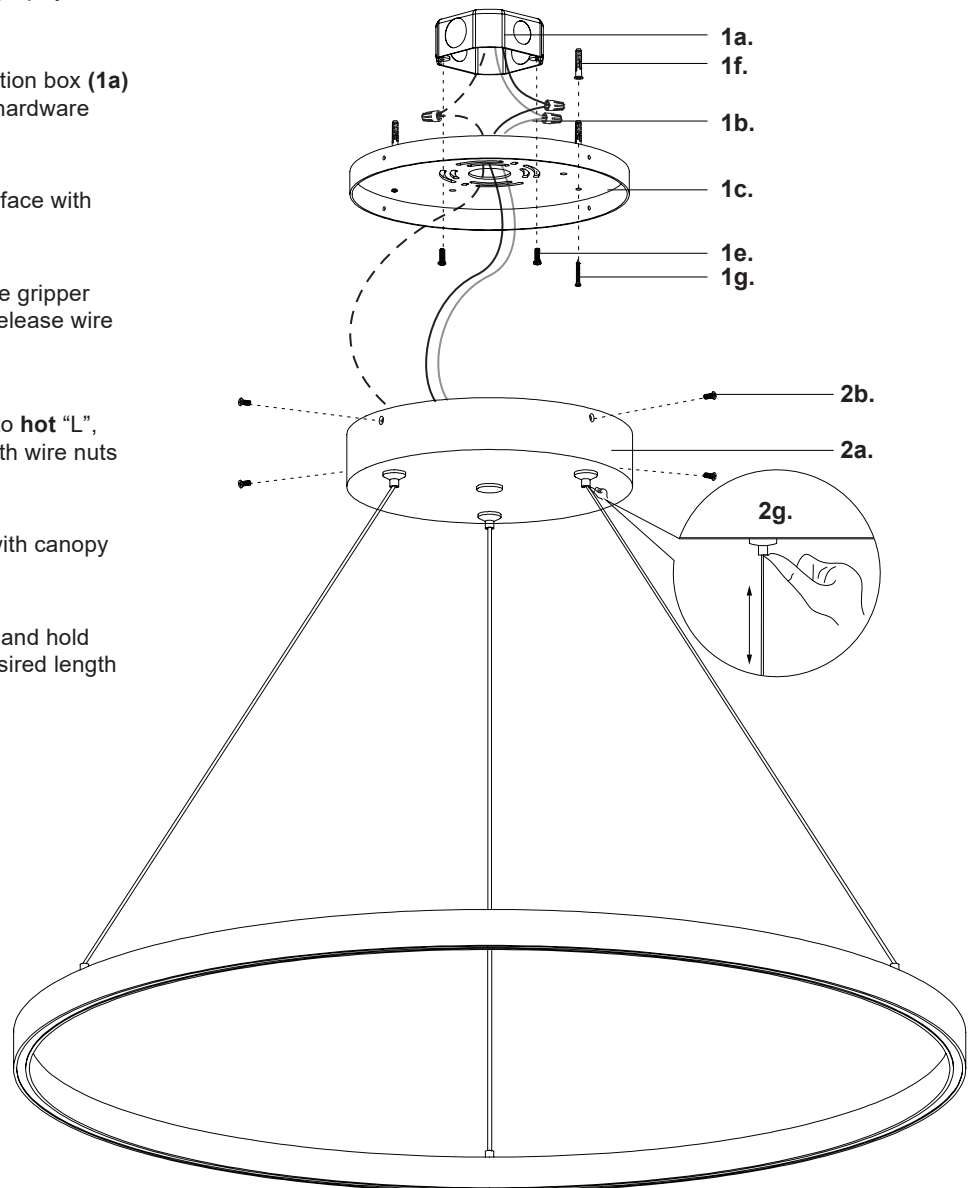

KUZCO

19054 28th Avenue Surrey, BC Canada V3Z 6M3
T: 604 538 7162 TF: 1-855 85 KUZCO F: 604 538 7196
W: kuzcolighting.com
20220520

Ceiling LED Pendant

PD87736
INSTALLATION SHEET

START FROM HERE

- Make sure **POWER** is **COMPLETELY OFF** at the fuse box
- Have your fixture installed by a qualified licensed electrician
- Prepare everything in a clear area
- Wear gloves at all time during this installation
- Read instructions carefully before you start assembly
- Keep this installation sheet for future reference

Technical Support: 1-855-855-8926

Please Note:

- This Kuzco LED fixture comes with pre-wired LED module(s)
- Unless instructed, Do Not touch any part of the LED module(s) as any unnecessary contact with the module could cause permanent damage
- Use ELV (Electronic Low Voltage) or TRIAC type of dimmer for dimming application
- 120V input

FOR ALTERNATIVE SIDE CANOPY INSTALL

1. Disconnect output wires on driver (4a)
2. Separate wire gripper (2g) from canopy (2a) by removing nut and tooth washer (6a). Separate plug (6b) from canopy (2a) by removing nut, tooth washer and flat washer (6c) (See Illustration 1)
3. Feed fixture wires through centre hole on canopy plate (7a), canopy (2a), tooth washer and nut (5a). Attach canopy plate (7a) to canopy (2a), followed by wire gripper (2g) and secure with tooth washer and nut (5a) (See Illustration 2)
4. Make proper electrical connections between LED and DC driver, LED- Negative, LED+ Positive using wago connector (4b) provided (See Illustration 3 and refer to diagram on driver)
5. Make proper electrical connections (black to hot "L", white to neutral "N", ground to "GND") with wire nuts (1b) provided in hardware package
6. Attach canopy (2a) to mounting plate (1c) with canopy screws (2b). Position desired amount of wire by pushing gripper (2g) on canopy
7. Pull wire through aircraft barrel (3b) and stopper (3d). Secure aircraft barrel (3b) to mounting surface with anchor (3c) and screw (3a). Adjust wire to desired length and secure with set screw (3e). Insert wire gripper (2g) into aircraft barrel (3b) to close
8. Fine tune wire length if necessary, by push and hold wire gripper (2g) and then adjust wire to desired length

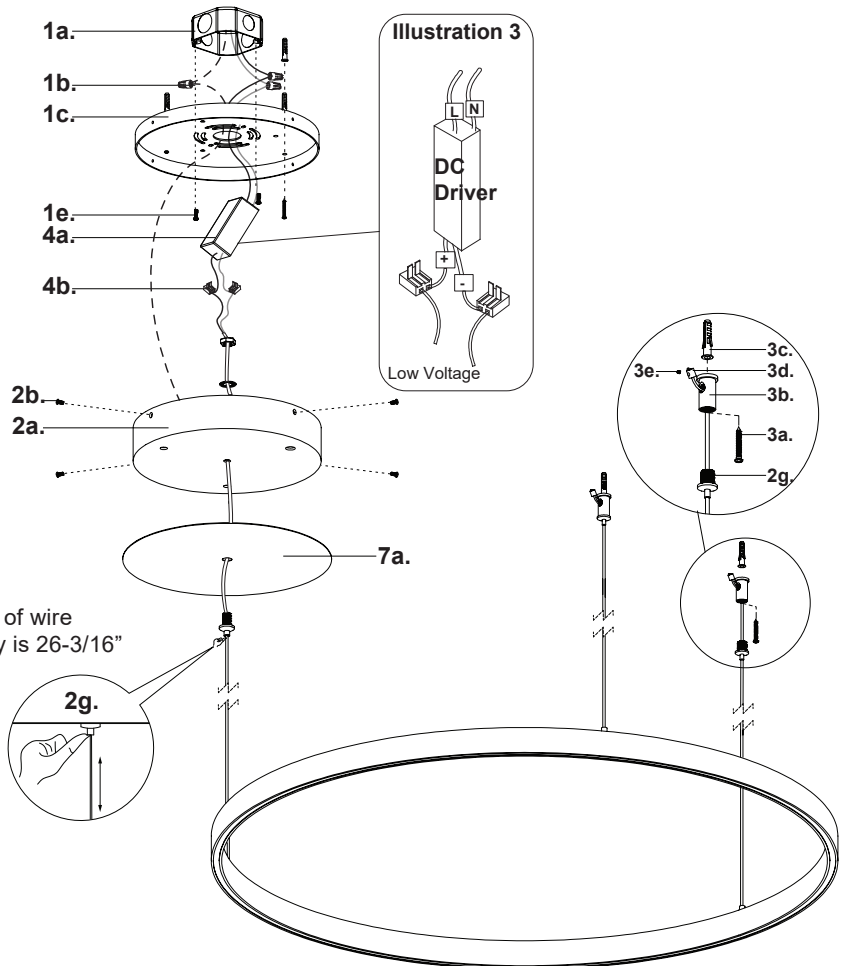
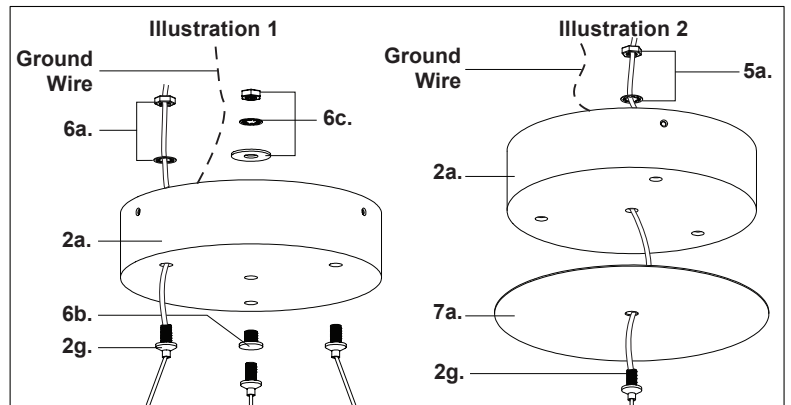

Note: Ideal distance of wire grippers from canopy is 26-3/16" and 30-3/16"

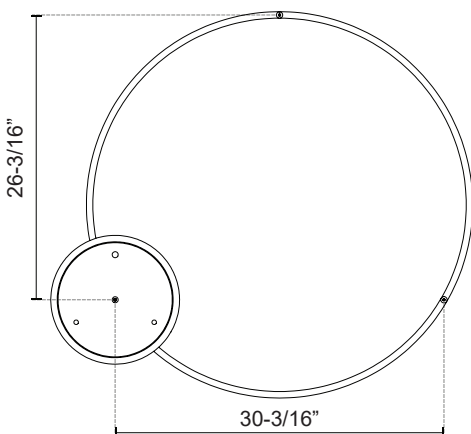

KUZCO

19054 28th Avenue Surrey, BC Canada V3Z 6M3
T: 604 538 7162 TF: 1-855 85 KUZCO F: 604 538 7196
W: kuzcolighting.com
20220520