

Ceiling LED Chandelier

CH87332
INSTALLATION SHEET

START FROM HERE

- Make sure **POWER** is **COMPLETELY OFF** at the fuse box
- Have your fixture installed by a qualified licensed electrician
- Prepare everything in a clear area
- Wear gloves at all time during this installation
- Read instructions carefully before you start assembly
- Keep this installation sheet for future reference

Technical Support: 1-855-855-8926

Please Note:

- This Kuzco LED fixture comes with pre-wired LED module(s)
- Unless instructed to do so, please do not touch any part of the LED module(s) as any unnecessary contact with the module could cause permanent damage.
- Use ELV (Electronic Low Voltage) or TRIAC type of dimmer for dimming application
- 120V input

CAUTION: HEAVY FIXTURE, THE JUNCTION BOX NEEDS TO BE REINFORCED BEFORE INSTALLATION. ALL MOUNTING SCREWS MUST SCREW INTO A MINIMUM OF 1" OF WOOD BEHIND THE DRYWALL. DO NOT MOUNT THIS FIXTURE JUST TO DRYWALL.

1. Remove fixture from its original package
2. Separate mounting plate (1c) from canopy (2a) by removing canopy screws (2b)
3. Attach mounting plate (1c) to electrical junction box (1a) using junction box screws provided (1e) in hardware package
4. Secure mounting plate (1c) to mounting surface with anchors (1f) and screws (1g)
5. To change fixture height, push and hold wire gripper (2g), slide wire to desired length and then release wire gripper (2g) to secure
6. Make proper electrical connections (black to hot "L", white to neutral "N", ground to "GND") with wire nuts (1b) provided in hardware package
7. Attach canopy (2a) to mounting plate (1c) with canopy screws (2b)
8. Fine tune wire length if necessary, by push and hold wire gripper (2g) and then adjust wire to desired length

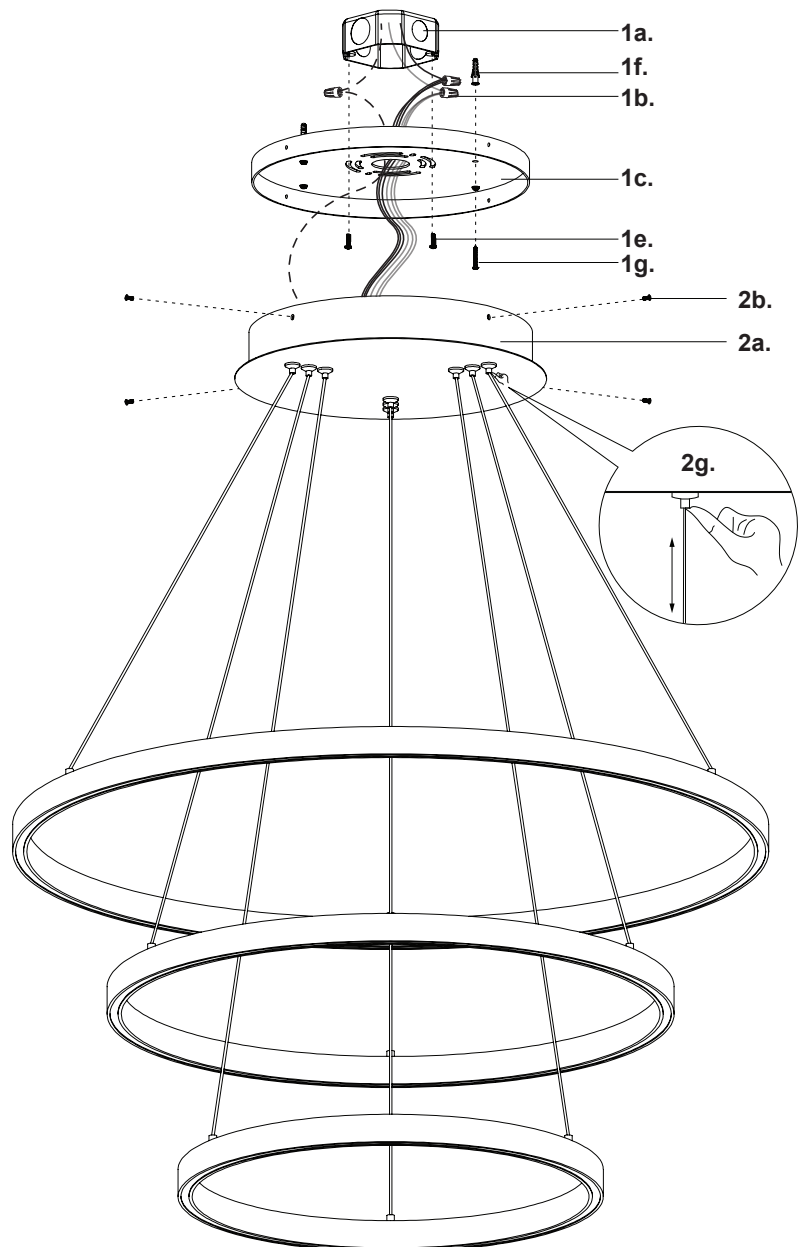

KUZCO

19054 28th Avenue Surrey, BC Canada V3Z 6M3
T: 604 538 7162 TF: 1-855 85 KUZCO F: 604 538 7196
W: kuzcolighting.com
20220322