

# Incandescent Semi Flush

**SF59708**  
INSTALLATION SHEET

## START FROM HERE

- Make sure **POWER** is **COMPLETELY OFF** at the fuse box
- Have your fixture installed by a qualified licensed electrician
- Prepare everything in a clear area
- Wear gloves at all times during this installation
- Read instructions carefully before you start assembly
- Keep this installation sheet for future reference

### Please Note:

- 120V input

**Technical Support:** 1-855-855-8926

- 1.** Remove fixture from its original package
- 2.** Separate mounting plate (**1c**) from canopy backplate (**2a**) by removing decorative nuts (**2c**)
- 3.** Align mounting plate screws (**1d**) to desired orientation, and then attach mounting plate (**1c**) to electrical junction box (**1a**) using junction box screws provided (**1e**) in hardware package
- 4.** Make proper electrical connections (**black** to **hot "L"**, **white** to **neutral "N"**, **ground** to **"GND"**) with wire nuts (**1b**) provided in hardware package
- 5.** Align and insert mounting plate screws (**1d**) through holes on canopy backplate (**2a**), secure with decorative nuts (**2c**)
- 6.** Attach canopy (**2d**) to canopy backplate (**2a**) with socket ring (**2e**) and secure with socket ring tool (**2f**)
- 7.** Attach shade (**3a**) to canopy backplate (**2a**) with shade connector (**3b**)
- 8.** Insert bulb (**4a**) into fixture socket

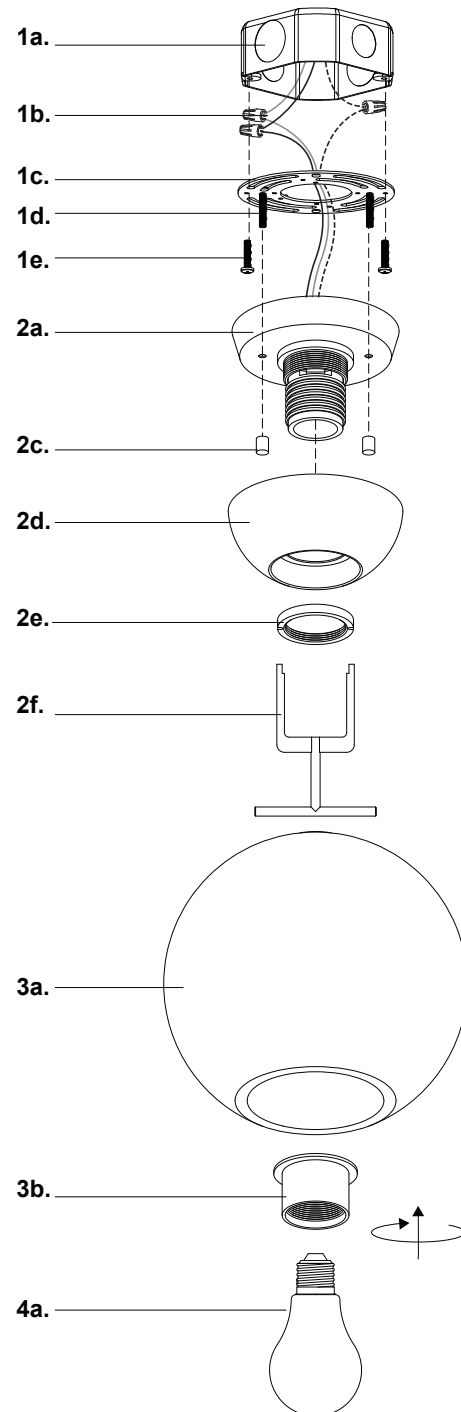

KUZCO

19054 28th Avenue Surrey, BC Canada V3Z 6M3  
T: 604 538 7162 TF: 1-855 85 KUZCO F: 604 538 7196  
W: kuzcolighting.com  
20230109