

Ceiling LED pendants.

CH3128

INSTALLATION SHEET

Please Note:

- All Kuzco LED fixtures come with pre-wired LED module(s).
- Unless instructed to do so, please do not touch any part of the LED module(s) as any unnecessary contact with the module could cause permanent damage.
- For dimming, an ELV (Electronic Low Voltage) dimmer is required.

START FROM HERE

- Make sure power is completely off at the fuse box.
- Have your fixture installed by a qualified licensed electrician
- Prepare everything in clear area.
- Wear gloves at all times during this installation.
- Read instructions carefully before you start assembly.
- Keep this instruction sheet for future reference.

Technical Support: 1-855-855-8926

1. Remove the fixture from its original packaging. Remove the canopy mounting bar from within the canopy by removing the decorative nuts. Secure the mount plate **(2b)** (with canopy screws facing downward) to the junction box.

2. Determine hanging height of fixture by securing rods **(2c)** to swivel **(2d)** in canopy **(2a)** and pendant body **(2e)**.

3. You are now ready to mount the canopy to the mounting plate first connect all wires correctly L live wire (white to white) N neutral wire (black to black) and G ground (green to green) with provided marrets from the hardware package **(3a)**. Align the threaded screws hanging downward from the mounting plate to the holes inside the canopy. Push the canopy up towards the ceiling so the two screws point through the hole in the canopy. You can then screw on the decorative nut **(3b)** onto the threaded bar pointing through the canopy to securely install the canopy to the mounting plate.

4. LED Engines are built in. Push the glass **(4a)** up to the LED engines **(4b)** and thread turning clockwise.

5. You have now completed the installation of your fixture, enjoy.

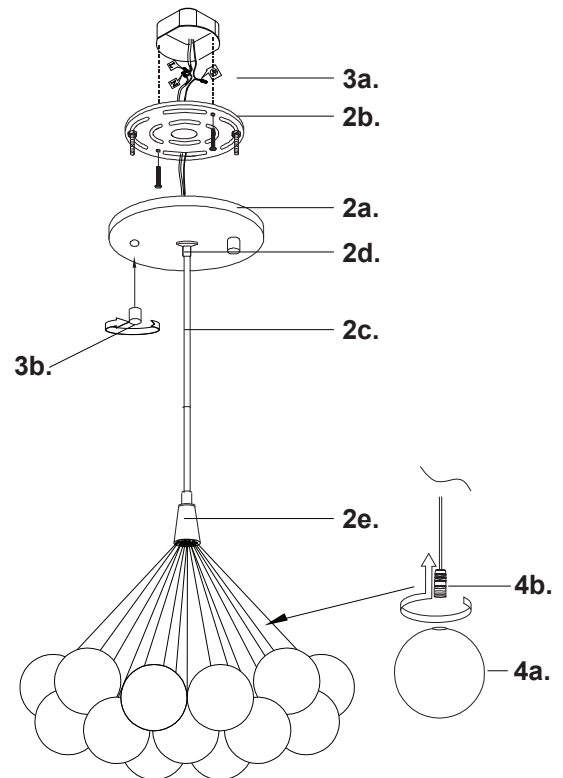

KUZCO

19054 28th Avenue Surrey, BC Canada V3Z 6M3
T: 604 538 7162 TF: 1-855 85 KUZCO F: 604 538 7196
W: kuzcolighting.com
20181127