

# Combi pendant

## Assembly Instructions

Suspension mount (with Circular canopy)



**Risk of shock.** An electric shock could cause serious injury or death. Make sure your circuit breaker is OFF before installation. This lamp must be installed by a qualified electrician.

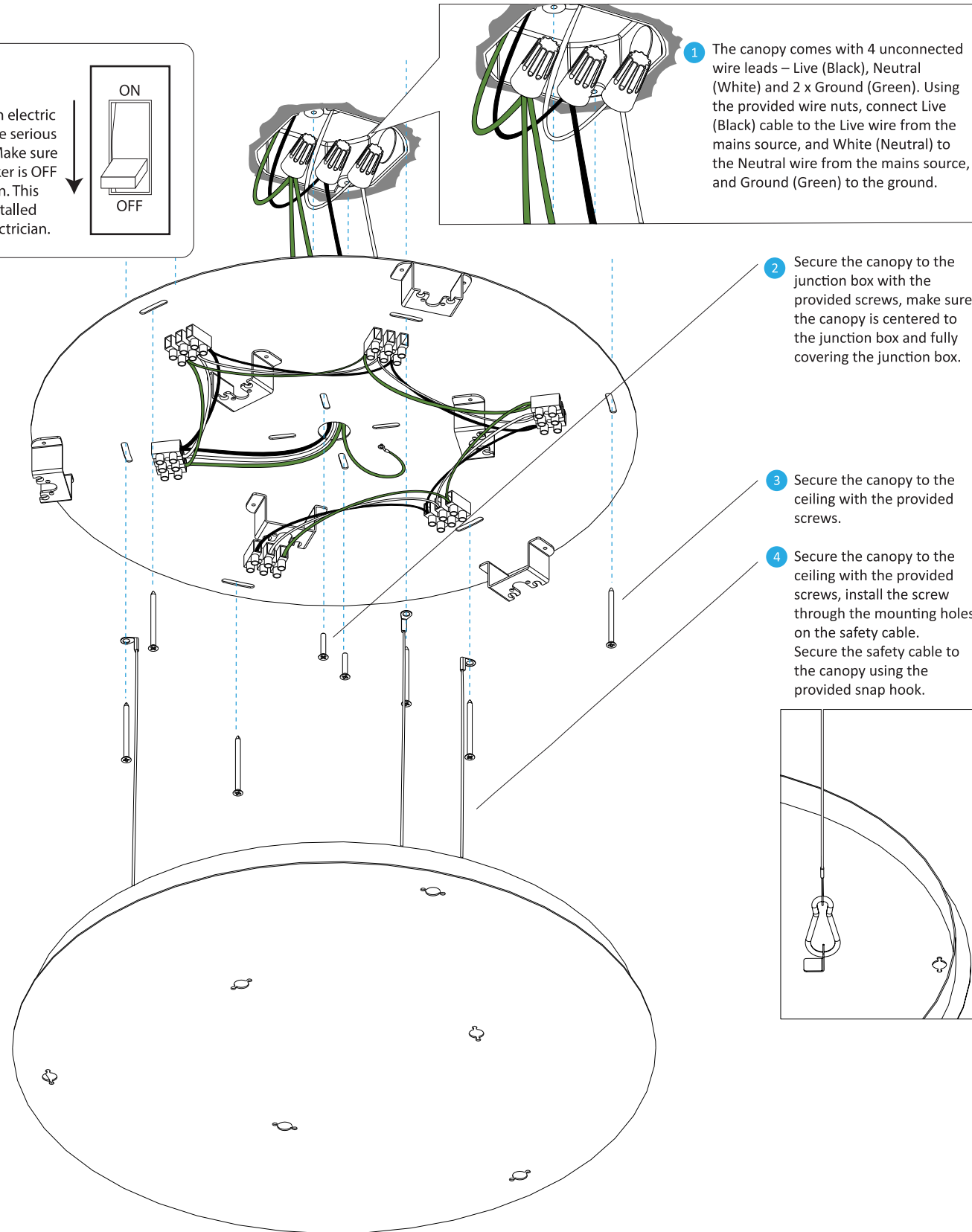
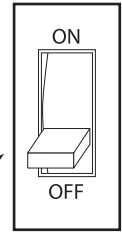

1 The canopy comes with 4 unconnected wire leads – Live (Black), Neutral (White) and 2 x Ground (Green). Using the provided wire nuts, connect Live (Black) cable to the Live wire from the mains source, and White (Neutral) to the Neutral wire from the mains source, and Ground (Green) to the ground.

2 Secure the canopy to the junction box with the provided screws, make sure the canopy is centered to the junction box and fully covering the junction box.

3 Secure the canopy to the ceiling with the provided screws.

4 Secure the canopy to the ceiling with the provided screws, install the screw through the mounting holes on the safety cable. Secure the safety cable to the canopy using the provided snap hook.

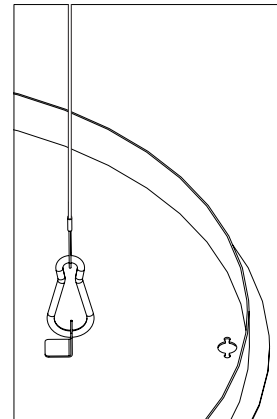

# Combi pendant

Assembly Instructions Suspension mount (with Circular canopy)

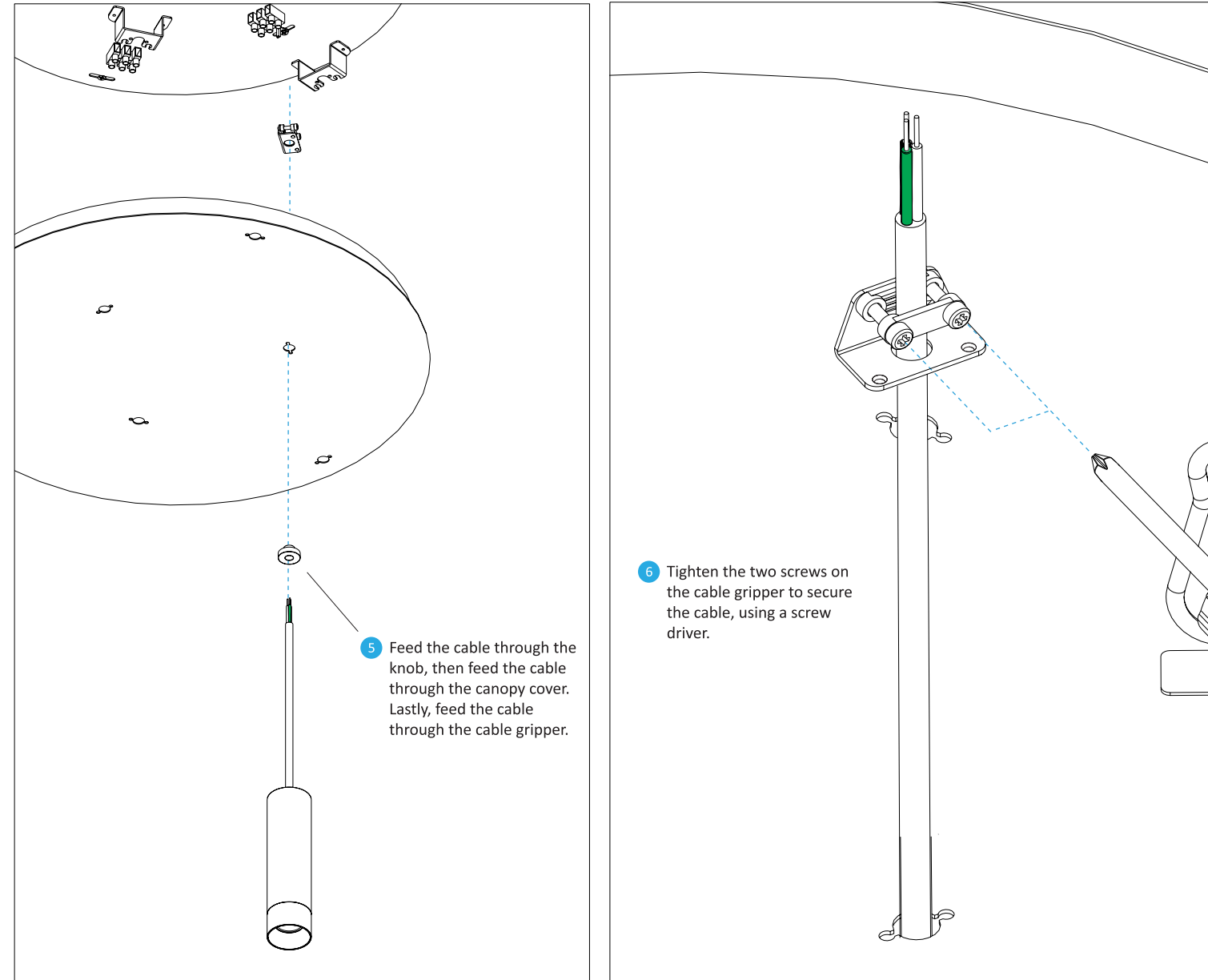

5 Feed the cable through the knob, then feed the cable through the canopy cover. Lastly, feed the cable through the cable gripper.

6 Tighten the two screws on the cable gripper to secure the cable, using a screw driver.

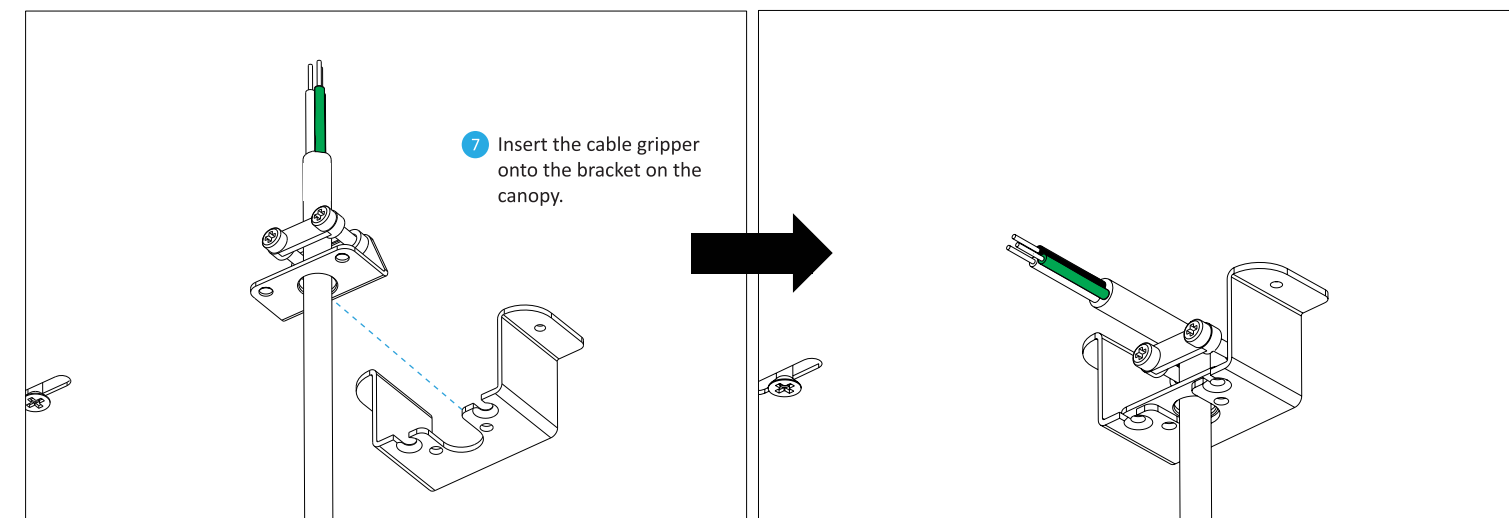

7 Insert the cable gripper onto the bracket on the canopy.

# Combi pendant

Assembly Instructions Suspension mount (with Circular canopy)

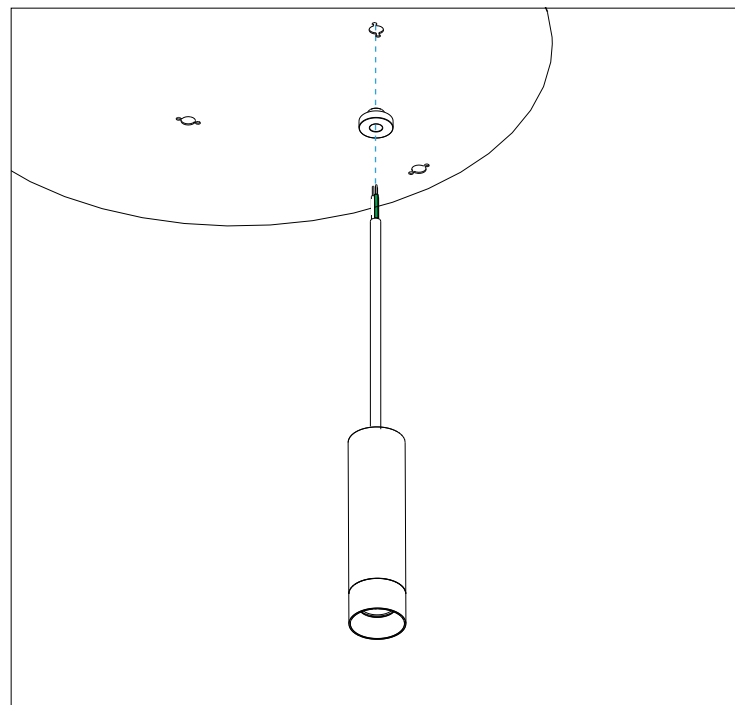
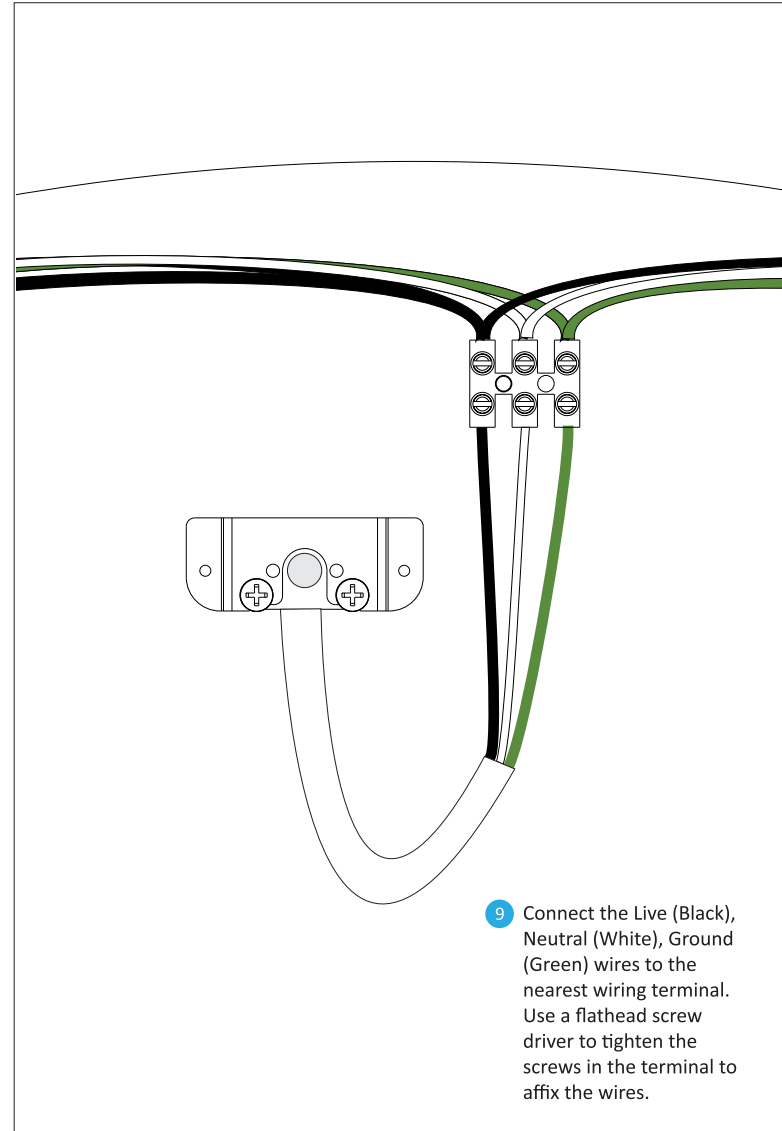
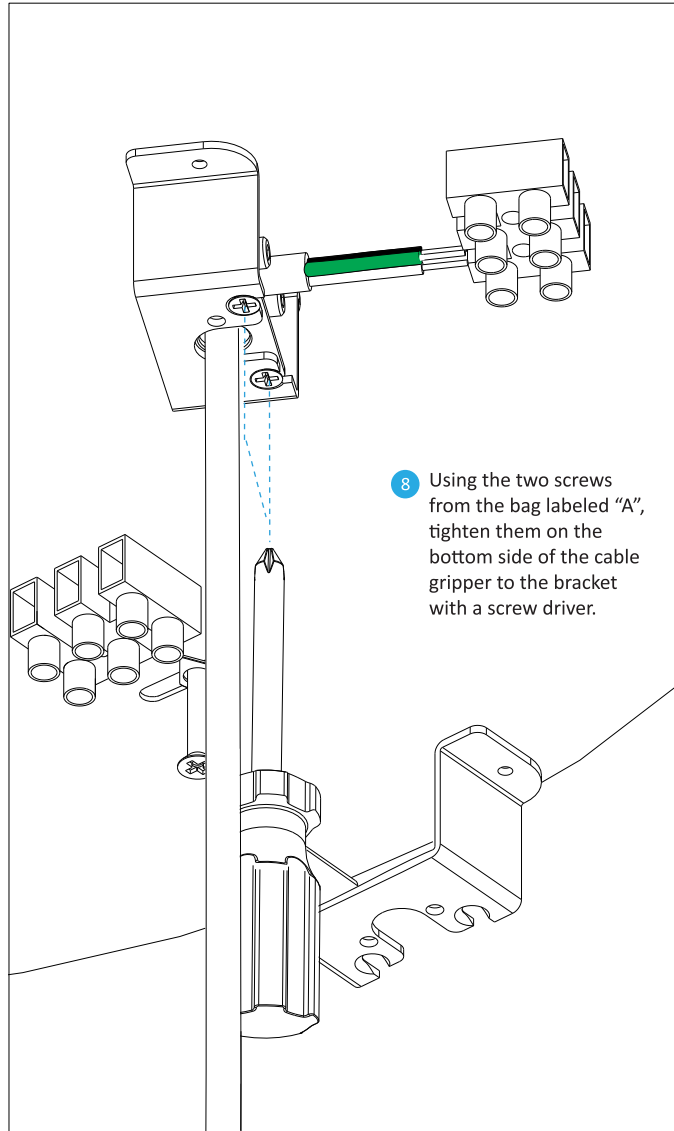

Repeat steps 5 - 9 to install all the Combi pendants to the canopy.

koncept

# Combi pendant

Assembly Instructions Suspension mount (with Circular canopy)

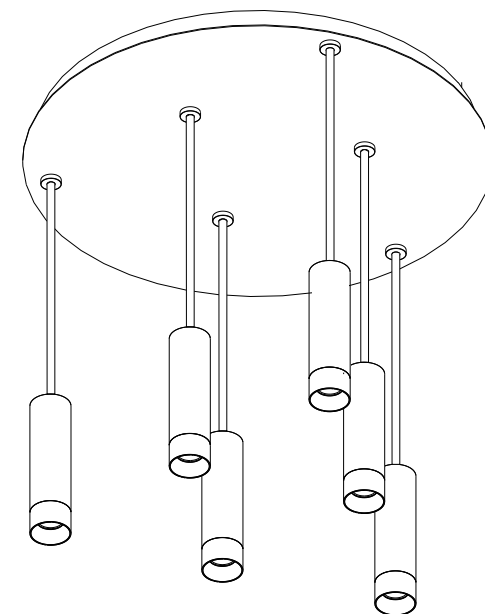
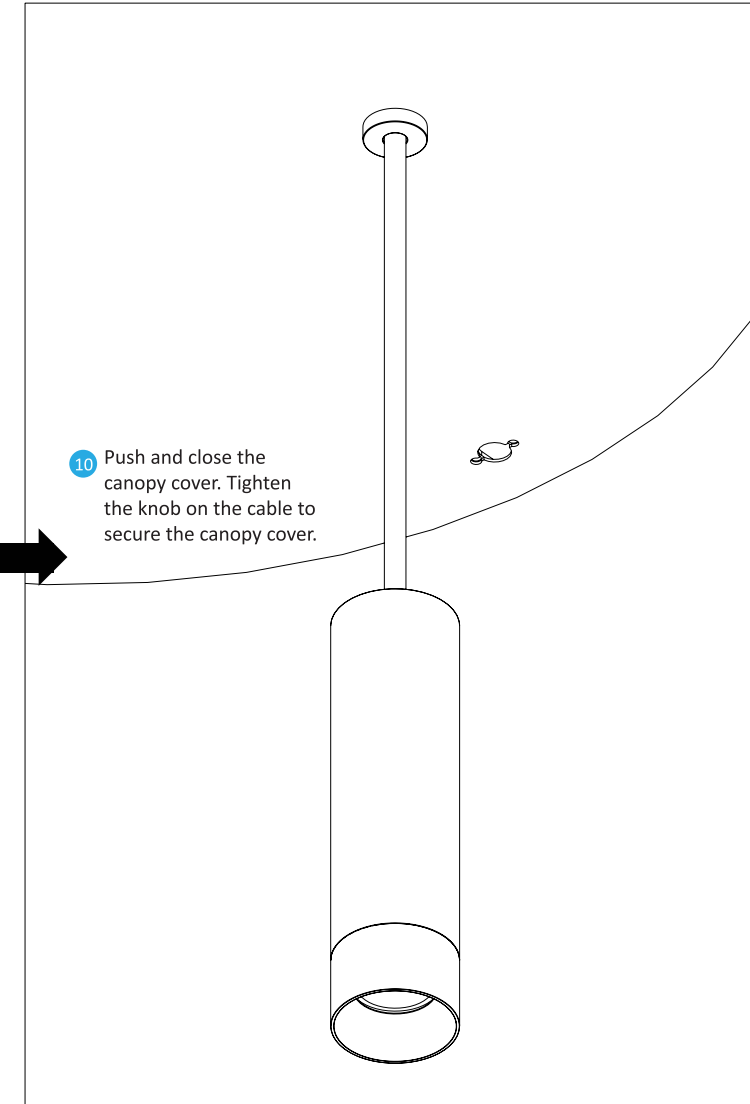
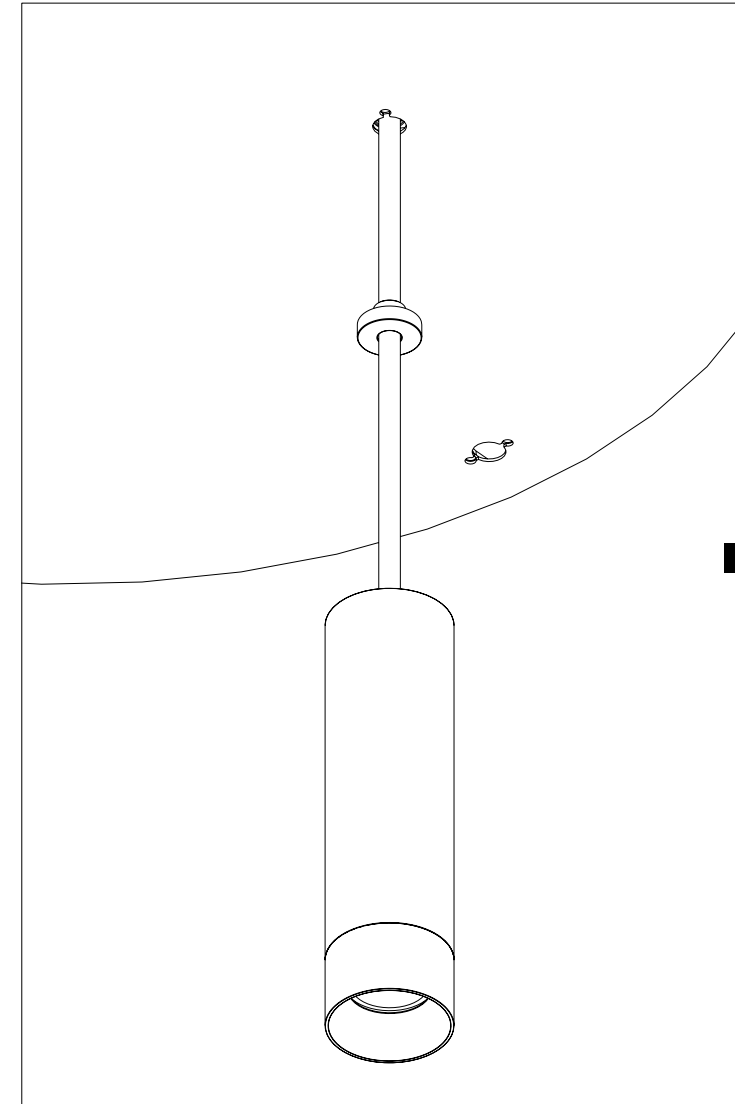

Installation complete.

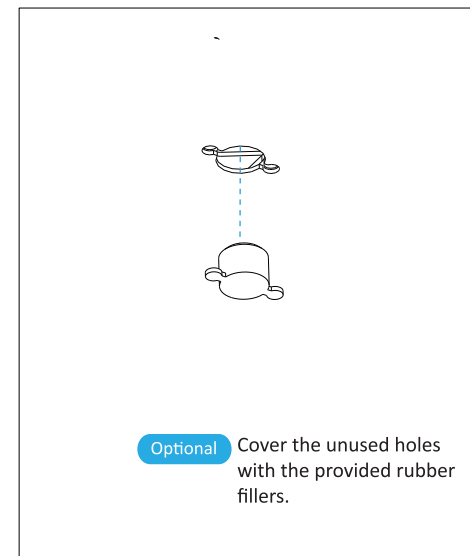

koncept

# Combi pendant

Assembly Instructions Flush mount (with Circular canopy)



**Risk of shock.** An electric shock could cause serious injury or death. Make sure your circuit breaker is OFF before installation. This lamp must be installed by a qualified electrician.

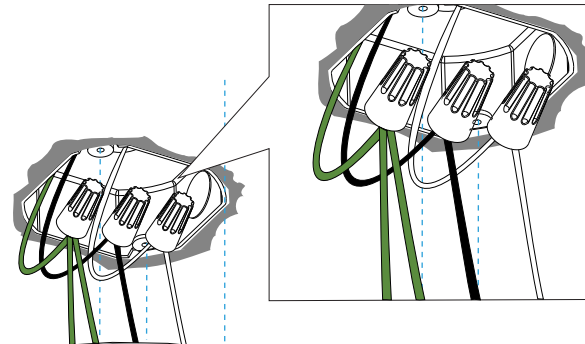
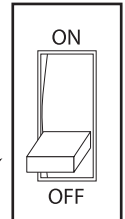

1 The canopy comes with 4 unconnected wire leads – Live (Black), Neutral (White) and 2 x Ground (Green). Using the provided wire nuts, connect Live (Black) cable to the Live wire from the mains source, and White (Neutral) to the Neutral wire from the mains source, and Ground (Green) to the ground.

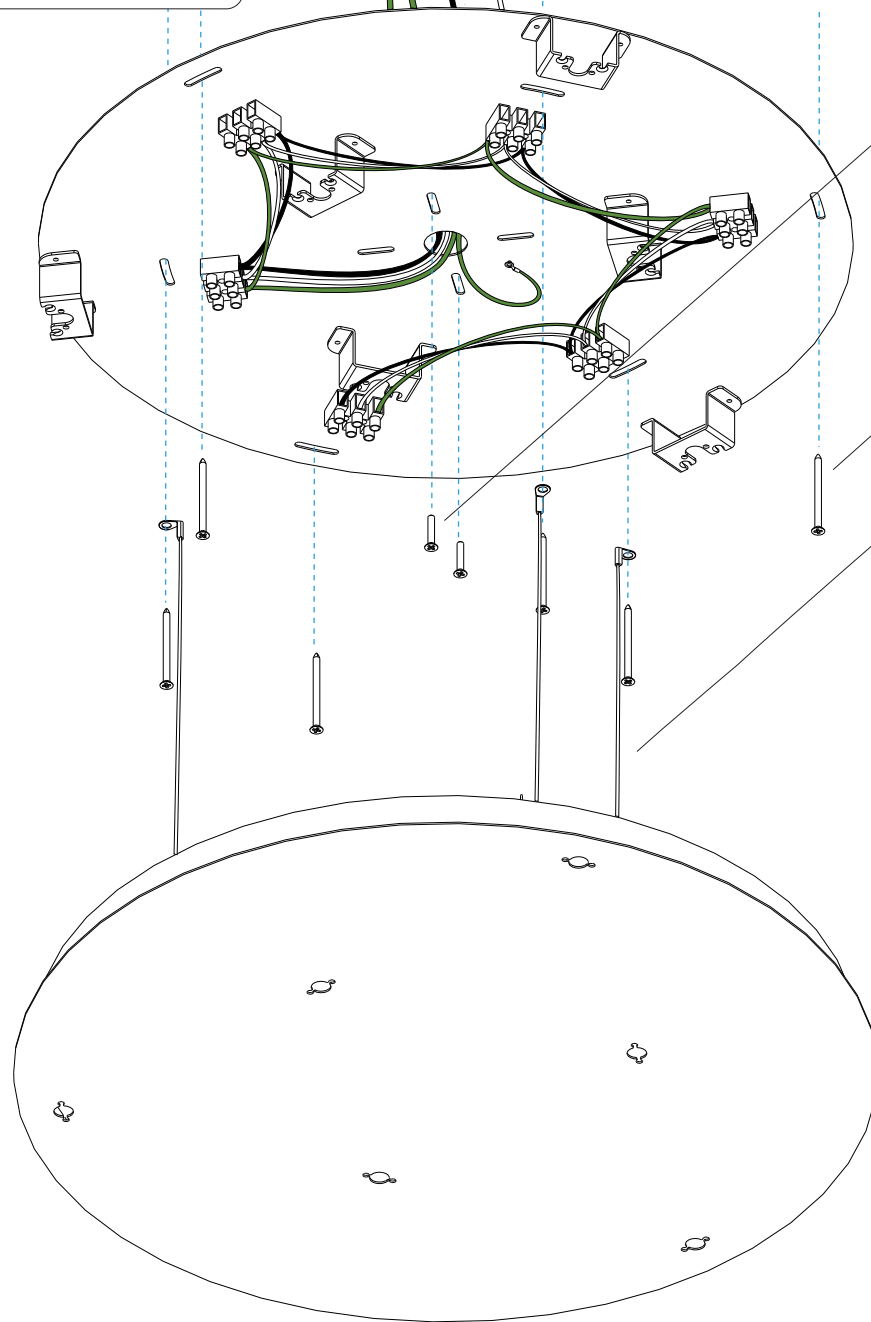

2 Secure the canopy to the junction box with the provided screws, make sure the canopy is centered to the junction box and fully covering the junction box.

3 Secure the canopy to the ceiling with the provided screws.

4 Secure the canopy to the ceiling with the provided screws, install the screw through the mounting holes on the safety cable. Secure the safety cable to the canopy using the provided snap hook.

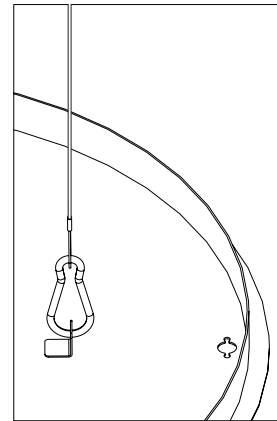

koncept

# Combi pendant

Assembly Instructions Flush mount (with Circular canopy)

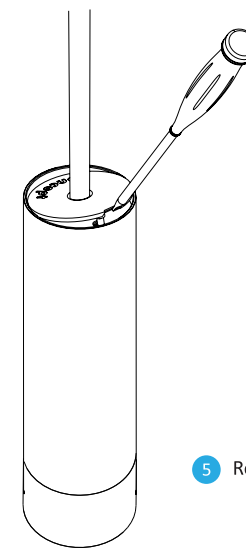

5 Remove top cap from the fixture.

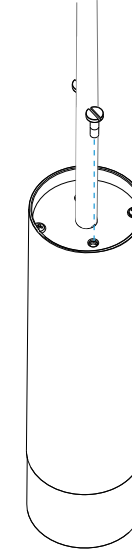

6 Screw on the two machine screws to the mounting holes towards the center.

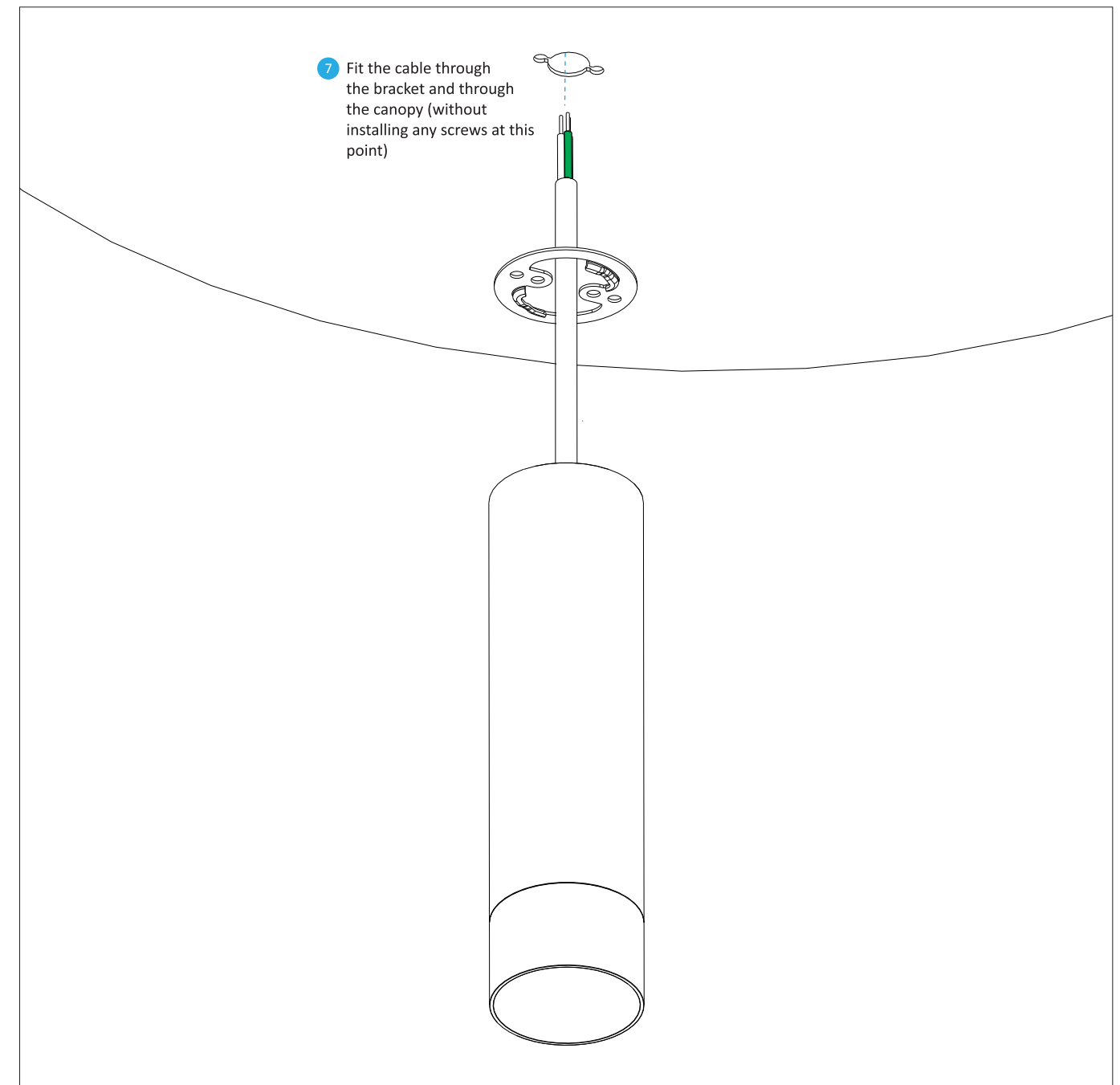
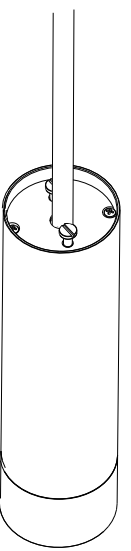

7 Fit the cable through the bracket and through the canopy (without installing any screws at this point)

# Combi pendant

Assembly Instructions Flush mount (with Circular canopy)

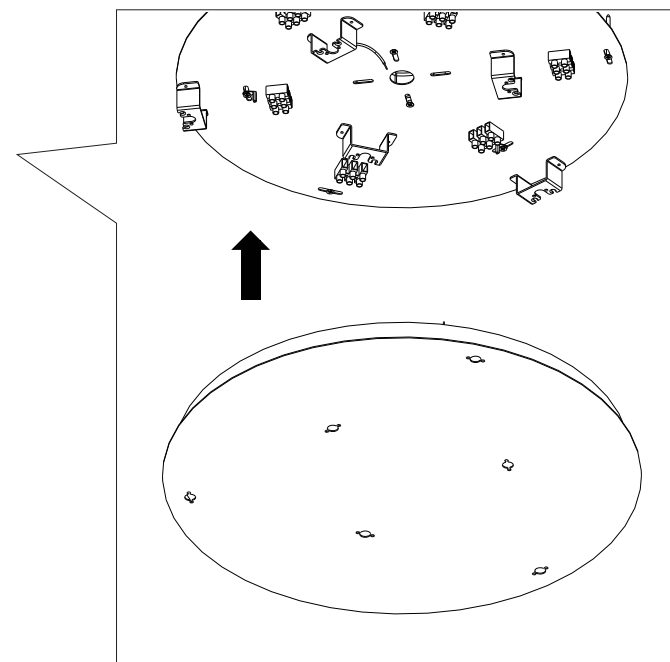
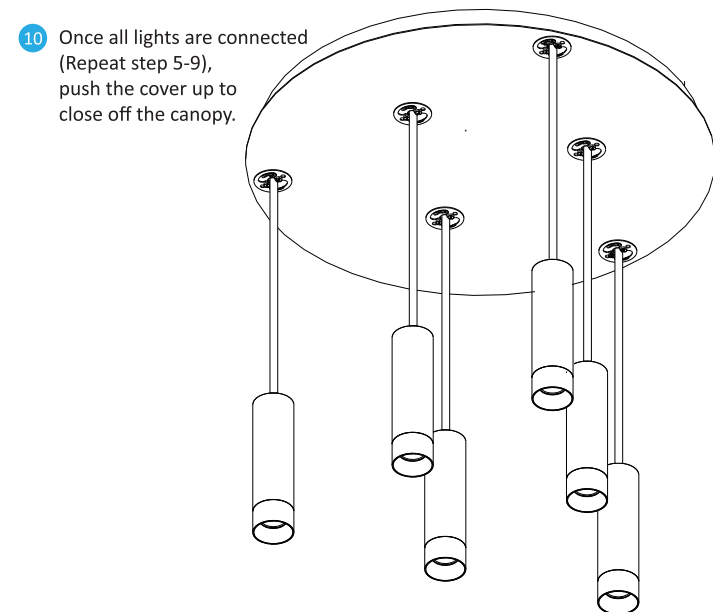
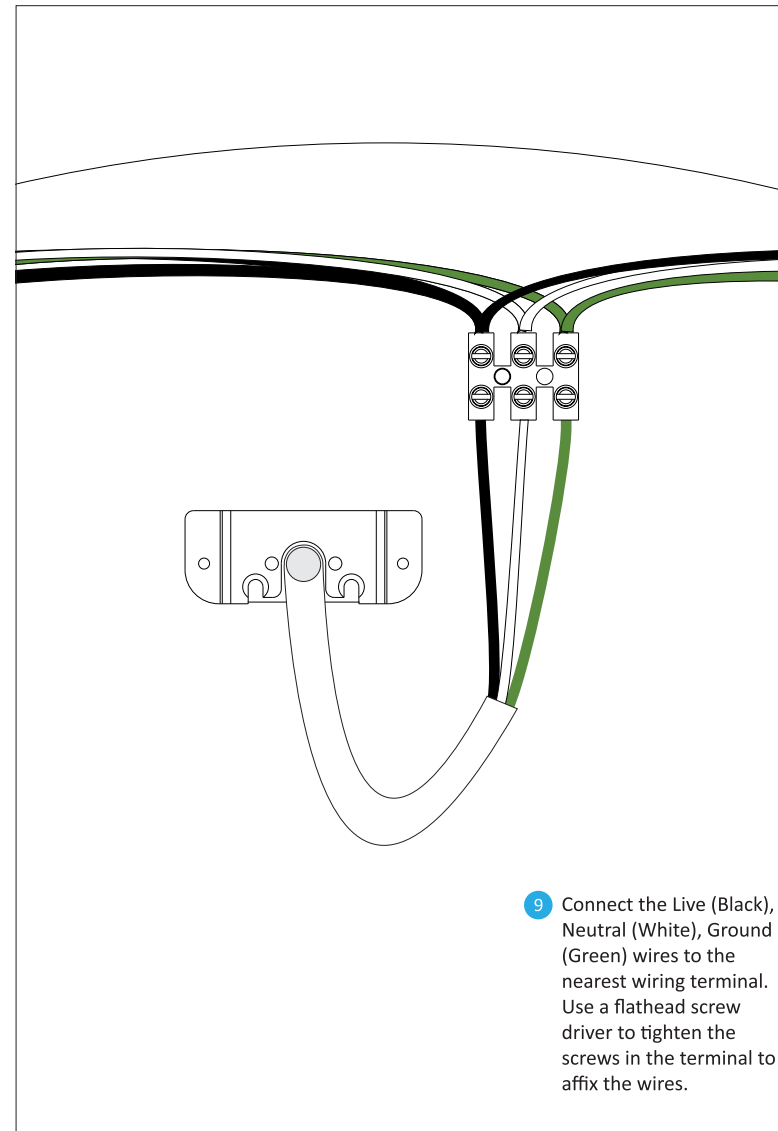
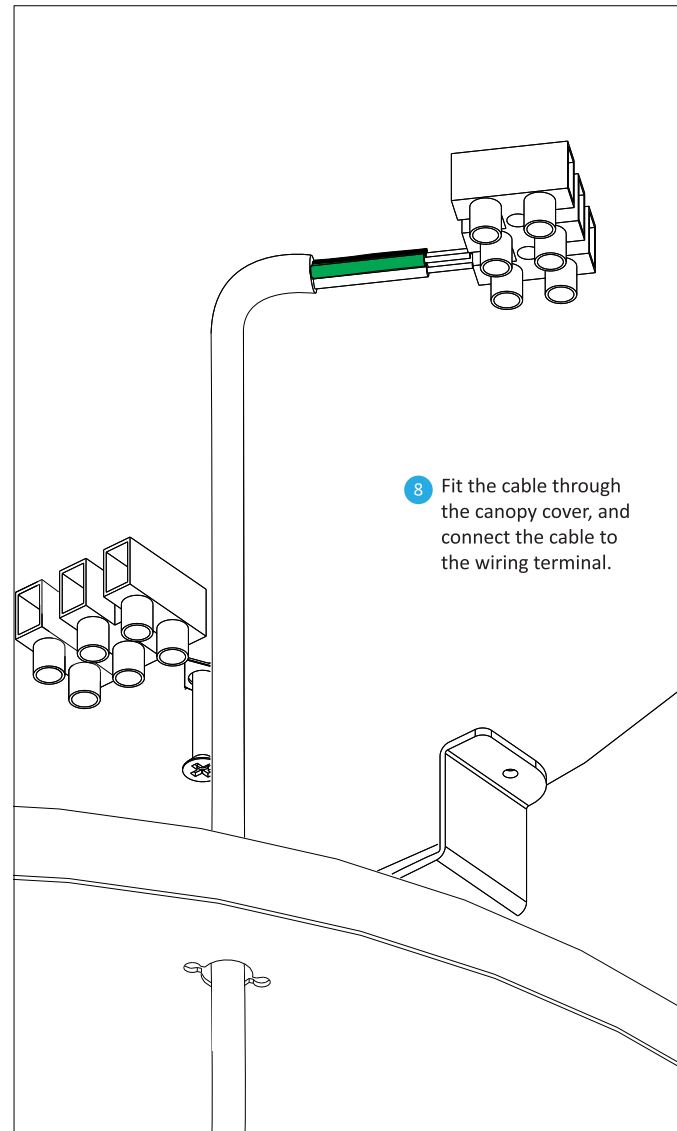

# Combi pendant

Assembly Instructions Flush mount (with Circular canopy)

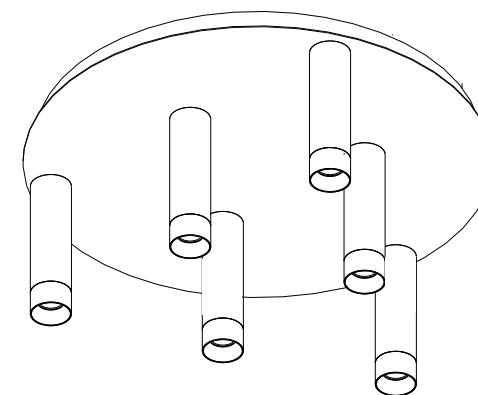
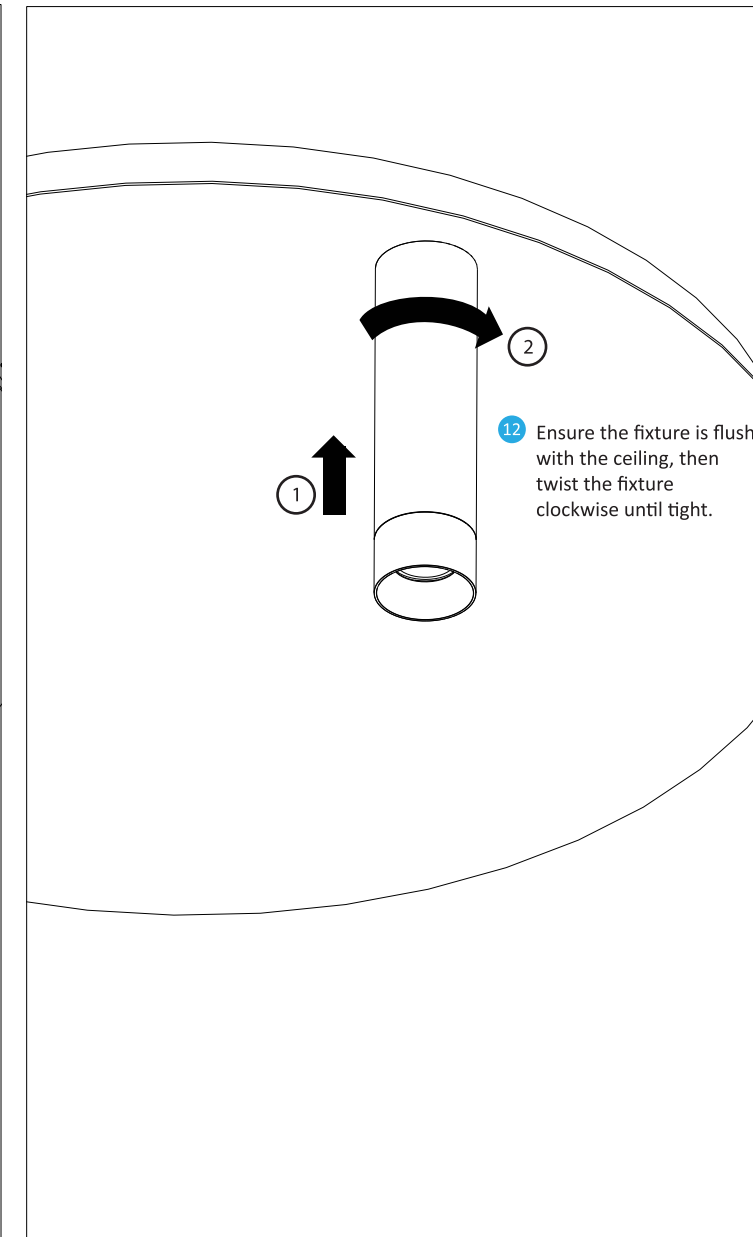
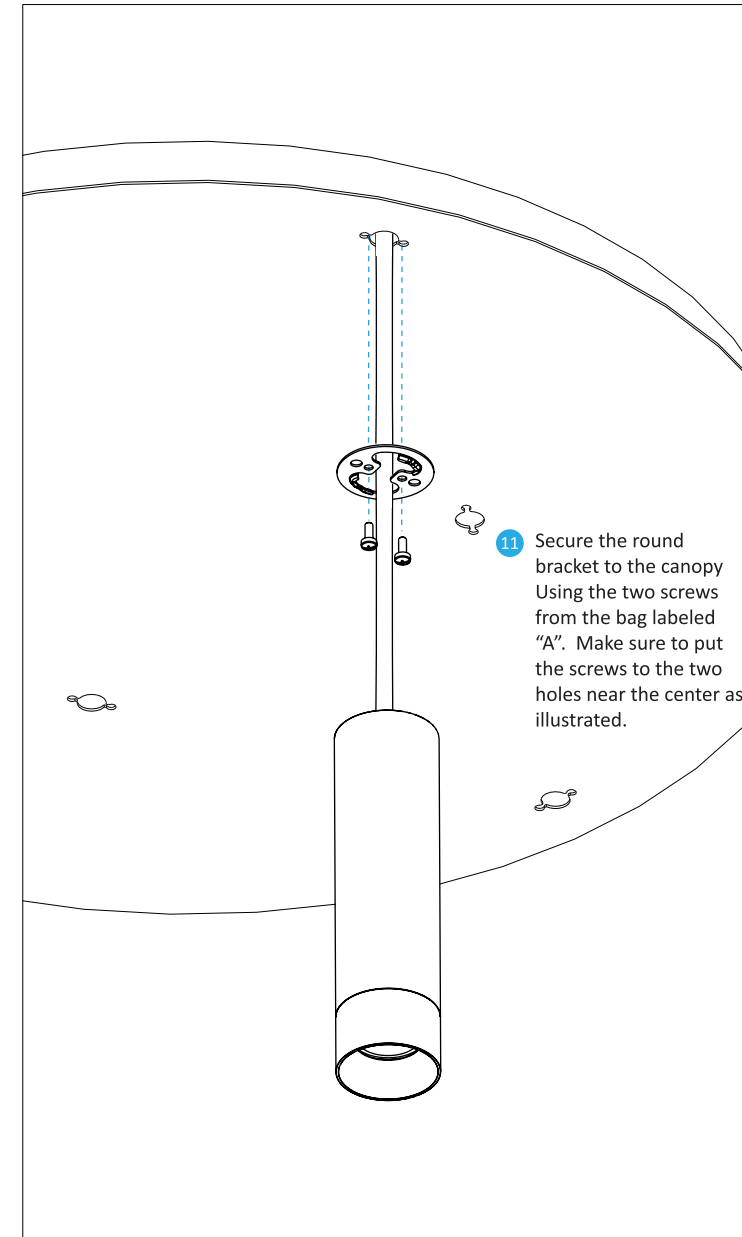

Installation complete.

