

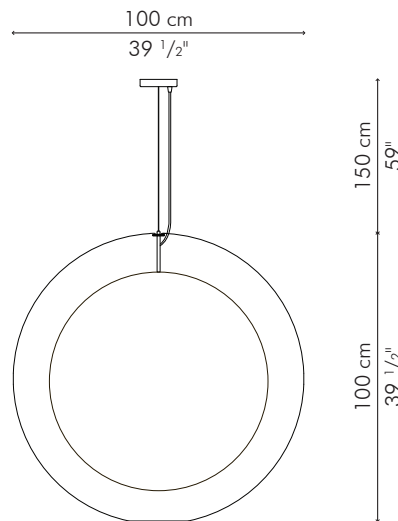

## HANGING LAMP, round large



 4.60 kg / 10 lbs

 14 kg / 31 lbs

 1.092 m<sup>3</sup>

1 x 100 watts

Surface mounted pre-wired lamp

E26 / E27

110V 60Hz / 230V 50Hz

**INDOOR** Salago fiber, steel, fiberglass reinforced polymer

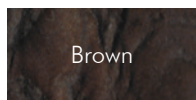

Brown

LPCC-B-3939

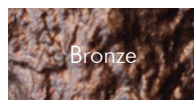

Bronze

LPCC-BZ-3939

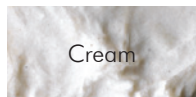

Cream

LPCC-C-3939

## HANGING LAMP, round medium

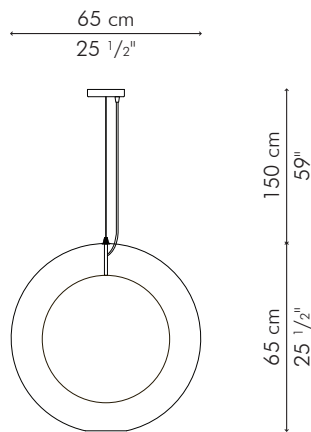

 1.60 kg / 4 lbs

 7 kg / 15 lbs

 0.321 m<sup>3</sup>

1 x 100 watts

Surface mounted pre-wired lamp

E26 / E27

110V 60Hz / 230V 50Hz

**INDOOR** Salago fiber, steel, fiberglass reinforced polymer

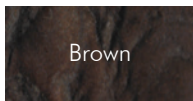

Brown

LPCC-B-2525

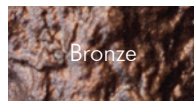

Bronze

LPCC-BZ-2525

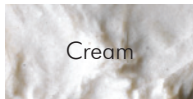

Cream

LPCC-C-2525

## HANGING LAMP, round small

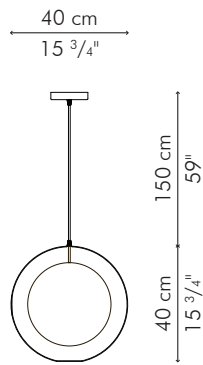

 0.75 kg / 2 lbs

 3 kg / 7 lbs

 0.085 m<sup>3</sup>

1 x 75 watts

Surface mounted pre-wired lamp

E26 / E27

110V 60Hz / 230V 50Hz

**INDOOR** Salago fiber, steel, fiberglass reinforced polymer

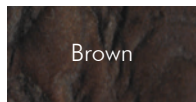

Brown

LPCC-B-1515

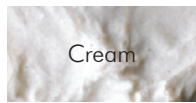

Cream

LPCC-C-1515

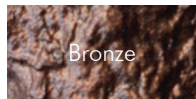

Bronze

LPCC-BZ-1515

## HANGING LAMP

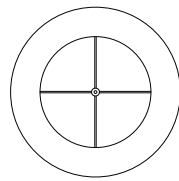

60 cm  
23 1/2"

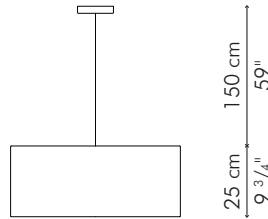

1.50 cm  
59"  
25 cm  
9 3/4"

 1.50 kg / 3 lbs

 3 kg / 7 lbs

 0.104 m<sup>3</sup>

1 x 100 watts

Surface mounted pre-wired lamp

E26 / E27

110V 60Hz / 230V 50Hz

**INDOOR** Salago fiber, steel, handmade paper, Mylar

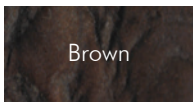

Brown

LHCC-B-2309

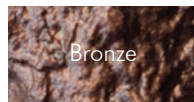

Bronze

LHCC-BZ-2309



Cream

LHCC-C-2309

## MIRROR, round



### LARGE

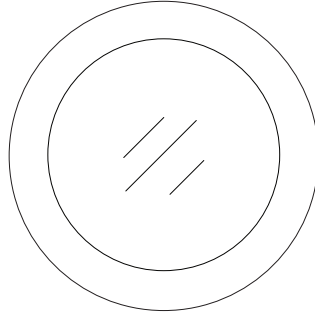
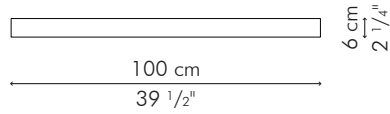

 13.05 kg / 29 lbs

 15.55 kg / 34 lbs

 0.38 m<sup>3</sup>

mirror glass  
80 cm Ø x 6 mm thickness  
(31 1/2" Ø x 1/4")



### SMALL

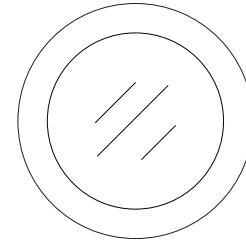
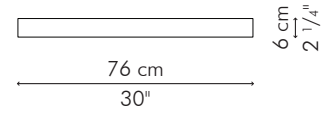

7 kg / 15 lbs

10.25 kg / 23 lbs

0.24 m<sup>3</sup>

mirror glass  
50.5 cm Ø x 6 mm thickness  
(20" Ø x 1/4")



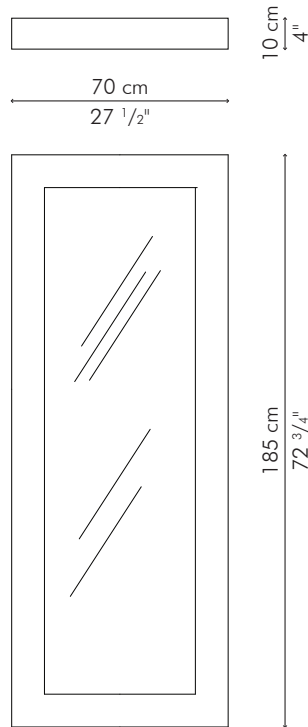

**INDOOR** Salago fiber, steel, mirror glass

## MIRROR, rectangular



 24 kg / 53 lbs

 25.85 kg / 57 lbs

 0.49 m<sup>3</sup>

mirror glass  
50 cm W x 165 cm H x 6 mm thickness  
(19 1/2" W x 65" H x 1/4")

**INDOOR** Salago fiber, steel, mirror glass

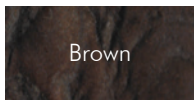

Brown

FMCC-B-2772-M

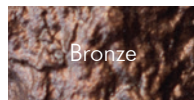

Bronze

FMCC-BZ-2772-M

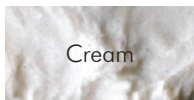

Cream

FMCC-C-2772-M