

Included Components

- Hardware Packet W, with Instructions
- Parallel Glass Panels (QTY:10) or Blown Glass (QTY:5)
- Canopy
- Braided Fabric Cord (QTY:5)
- Cord grip (QTY:5 — Attached to canopy)
- If Blown Glass (Set Screws, QTY:10)
- If Parallel Glass (All Thread & Cylinder Knobs QTY: 20)
- If Ledgestone Glass (Set Screws, QTY: 20)

Required Tools

- Allen Key (provided)
- Phillips screw driver (not provided)
- Wire cutters/strippers (not provided)
- Measuring tape (not provided)

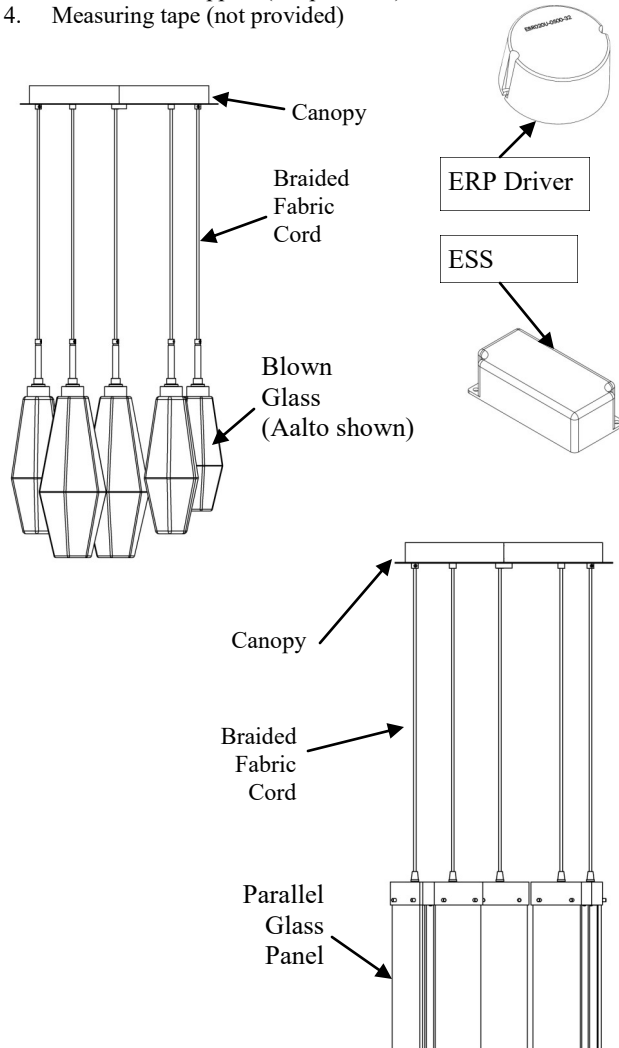

Assembly Instructions

Step 1: Feed the braided fabric cord into the canopy until the desired amount of cord is left between the canopy and light body. Take into account that a minimum of 6" of cord will be required for connecting the wiring to the driver.

Step 2: Use the measuring tape to be sure that all of the light bodies are hanging the proper distance from the canopy. Tighten the cord grip using a flat blade screw driver. The cord grip is on the face of the canopy. **DO NOT OVER TIGHTEN. THIS MAY DAMAGE THE FIXTURE.**

Step 3: Make Wire Connections to the drivers, mounted inside of the canopy. The EBR020U-0500-42 driver will be wired in series with 4 pendants. The ESS010W-0500-12 driver will be wired with 1 pendant. Braided fabric cord must be wired to the Driver, **black to black and white to red.** To wire in series make the following connections:

WARNING

DO NOT DIRECTLY CONNECT LEDs TO AC POWER. LEDs will be damaged if exposed to high voltages. The LED's must be wired in series to work properly.

Wiring of One Pendant
ESS010W-0500-12

Wiring of Four Pendants
EBR020U-0500-42

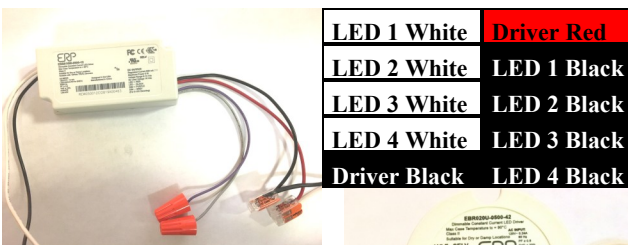

Both drivers will come wired as shown below, simply plug in your ac power source.

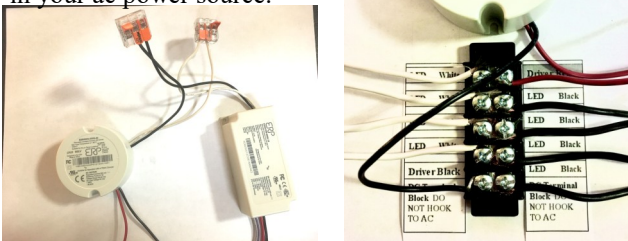

NOTE: The **Grey** and **Purple** wires are used for 0-10V dimming. If not applicable cap wires. Wires must be **capped separately**, or pendant will dim to zero.

Step 4: Make wire connections from driver to supply. **White to white, black to black**, and ground the fixture to the canopy.

Step 5: Mount the canopy to the ceiling using the provided **Mounting Instructions.**

Step 6: Attach glass to LED pendant housing:
Gem, Hedra, Rock Crystal, or Aalto Pendant:
Use #4-40 flat head screws provided to attach glass to pendant housing.

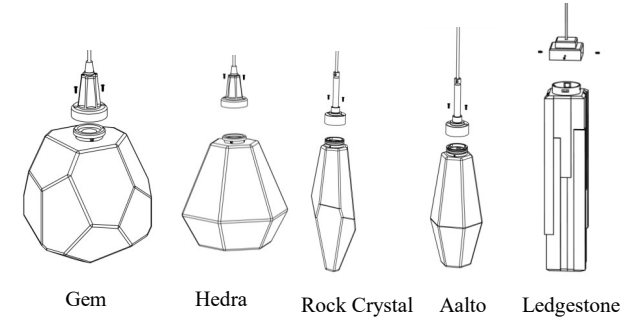

Ledgestone Pendant:

Use #8-32 nylon tip set screws to retain blown glass

If Axis Pendant:

Slide glass along retention screws using slot in glass. Slide pendant cover over glass and tighten finial until snug.

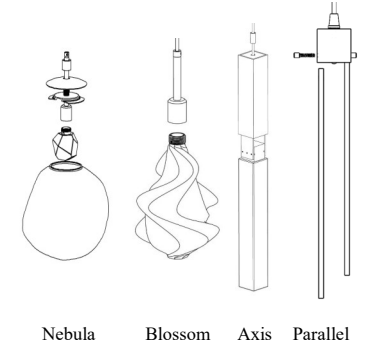

Blossom Pendant:

Screw glass element into threaded pendant housing

If Nebula Pendant: Screw inner glass into socket. Un-Screw Glass Retention nut. Raise the Top Glass Retention Cap up the stem. Slide Glass Shade over inner glass, tilt to the side of the glass allowing the Bottom Glass Retention to slip inside the Glass Shade, slide the rest of the Bottom Glass Retention the rest of the way into the Glass Shade, Allow the Glass to sit on the top of the lips of the Bottom Glass Retention. Lower the Top Glass Retention Cap, center the fixture on the Bottom Glass Retention and Secure Retention Nut. **(NOTE: Tighten till Snug. DO NOT Overtighten!)**

Parallel Glass Pendant:

Install glass panels by unscrewing the cylinder knobs until glass can be slid into housing.

Note that the cylinder knobs do not have to be fully removed from the fixture to install glass panels.

Tighten the cylinder knobs, ensuring that the all thread passes through the glass panels.

About Hammerton Studio

HAMMERTON STUDIO

In 2013, the Hammerton Studio brand was created to offer artisan-crafted, contemporary design solutions that are both versatile and accessible. Hammerton Studio fixtures add contemporary distinction to entries, great rooms and master suites, yet are cost-effective enough to use throughout any residential or commercial projects. Like all Hammerton fixtures, they are designed and fabricated in Salt Lake City, Utah using domestically sourced materials.

POWERFUL DESIGN

Since 1992, Hammerton has been known for extraordinary decorative lighting that is boldly designed, expertly rendered, perfectly proportioned and exquisitely detailed. Each fixture exudes a design aesthetic that is timeless and enduring, yet remarkably relevant.

UNCOMPROMISING CRAFTSMANSHIP

In addition to their exceptional metalworking and finishing expertise, Hammerton artisans share an aesthetic eye and a sculptural talent that define the difference between ordinary and extraordinary craftsmanship. Every fixture demonstrates its artisan's ability to elevate craft to an art form.

UNIQUE MATERIALS

Our heritage is in metal fabrication, but our passion is design. As a result—and unlike most of our peers—we work in a broad palette of materials: steel and aluminum, blown, kiln-fired and lampworked glass, acrylics, mica, stone, rawhide, woods and much more. Seamless integration of these capabilities is the "secret sauce" that drives our industry leadership as the premier U.S. based custom lighting manufacturer.

A REPUTATION REFLECTED BY OUR CLIENTS

Hammerton fixtures are as extraordinary as the clients who purchase them, including Forbes 400 members, Fortune 500 leaders, award-winning entertainers, fashion and interior designers, sports legends, and leading luxury hospitality brands.

Hammerton
217 Wright Brothers Drive
Salt Lake City, UT
84116

801-973-8095
info@hammerton.com
www.hammerton.com

Warranty

ONE YEAR LIMITED WARRANTY

Hammerton, Inc. (Hammerton) warrants the original owner that this product will be free of defects in material or workmanship for the period of one year from the date of original purchase from Hammerton, if (i) the allegedly defective product has not been abused, misused or improperly maintained and or repaired during the warranty period, (ii) the defect is not caused by water damage/flooding, fire, explosion, earthquakes or similar phenomenon, and (iii) the defect is not caused by improper installation (unless installed by Hammerton).

In order to obtain warranty service, the user must first complete a warranty claims form. Hammerton will determine if the product will be inspected on site or returned to Hammerton. If after the inspection Hammerton finds that the product is defective as claimed, Hammerton will, at its option, repair or replace the product free of charge, or Hammerton may in its sole discretion, refund the purchase price. Hammerton warrants any replaced or repaired products for ninety days after shipment or through the end of the original warranty period, whichever is longer. All products or parts that are replaced become the property of Hammerton. No representative or employee of Hammerton is authorized to make any modification or addition to this limited warranty.

TO THE FULL EXTENT ALLOWED BY LAW, THE FOREGOING WARRANTY AND REMEDIES ARE EXCLUSIVE, AND HAMMERTON EXPRESSLY DISCLAIMS ALL OTHER WARRANTIES, EXPRESSED OR IMPLIED, INCLUDING WITHOUT LIMITATION THE IMPLIED WARRANTIES OF MERCHANTABILITY AND FITNESS FOR A PARTICULAR PURPOSE. TO THE FULL EXTENT ALLOWED BY LAW, HAMMERTON EXCLUDES AND DISCLAIMS LIABILITY, WHETHER BASED IN CONTRACT OR TORT (INCLUDING NEGLIGENCE FOR ANY CONSEQUENTIAL, INDIRECT INCIDENTAL OR SPECIAL DAMAGES OF ANY NATURE ARISING OUT OF THE SALE INSTALLATION, MAINTENANCE, USE OR FAILURE OF THIS PRODUCT, EVEN IF HAMMERTON HAS BEEN ADVISED OF THE POSSIBILITY OF SUCH DAMAGES IN ADVANCE, AND HAMMERTON LIMITS ITS LIABILITY TO REPLACEMENT, REPAIR OR REFUND OF THE PURCHASE PRICE PAID, AT HAMMERTON'S OPTION.) SOME STATES DO NOT ALLOW LIMITATIONS ON HOW LONG AN IMPLIED WARRANTY LASTS AND/OR DO NOT ALLOW THE EXCLUSION OR LIMITATION OF INCIDENTAL OR CONSEQUENTIAL DAMAGES, SO THE ABOVE LIMITATION ON IMPLIED WARRANTY AND INCIDENTAL OR CONSEQUENTIAL DAMAGES MAY NOT APPLY TO YOU. THIS WARRANTY GIVES YOU SPECIFIC LEGAL RIGHTS YOU MAY HAVE OTHER RIGHTS, WHICH VARY FROM STATE TO STATE

HAMMERTONSTUDIO™

Assembly Instructions

CHB0039-05, CHB0042-05, CHB0045-05, CHB0049-05, CHB0050-05, CHB0056-05, CHB0060-05, CHB0059-05, CHB0066-05, CHB0067-05, CHB0068-05, CHB0069-05

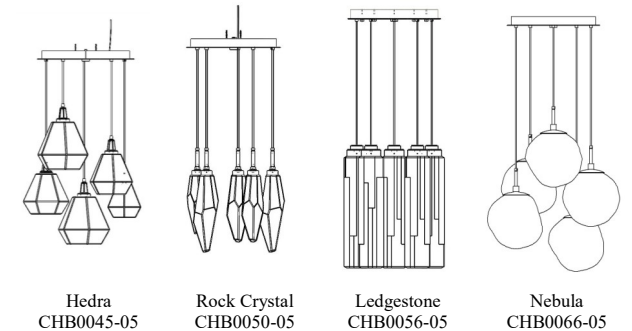
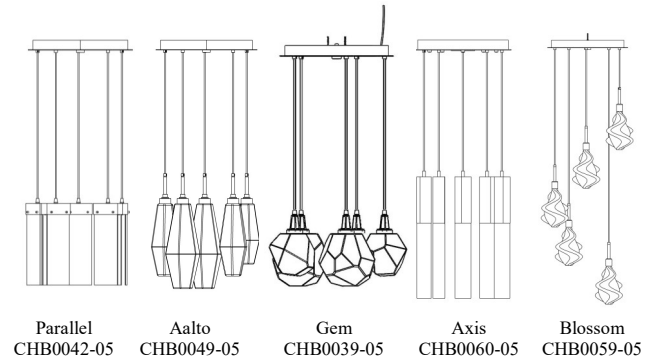

WARNING: FAILURE TO INSTALL THIS FIXTURE PROPERLY MAY RESULT IN SERIOUS PERSONAL INJURY OR DEATH AND PROPERTY DAMAGE.

It is recommended that this product be installed by a licensed electrician who is familiar with proper LED installation and electrical loads.

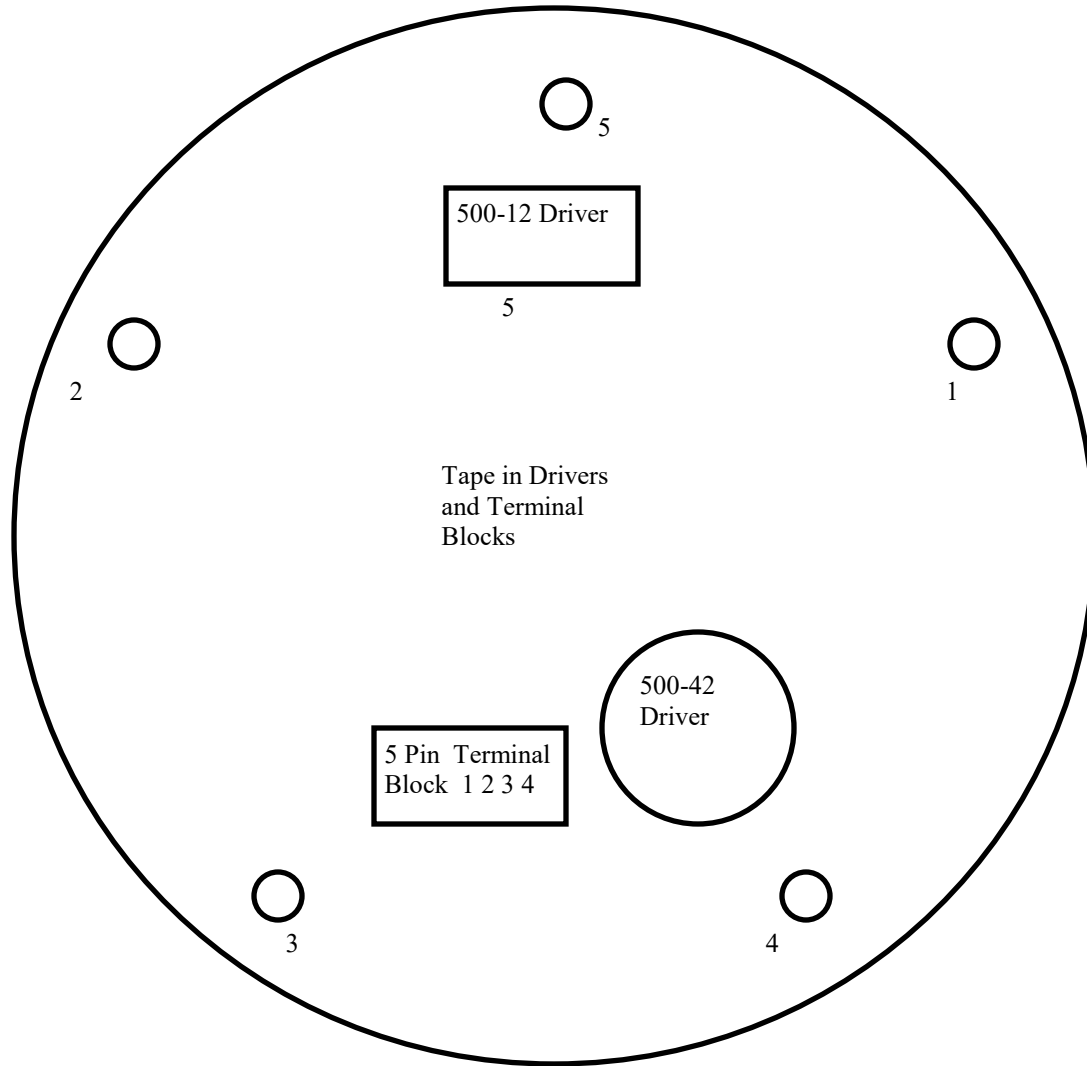

About Hammerton Studio

HAMMERTON STUDIO

In 2013, the Hammerton Studio brand was created to offer artisan-crafted, contemporary design solutions that are both versatile and accessible. Hammerton Studio fixtures add contemporary distinction to entries, great rooms and master suites, yet are cost-effective enough to use throughout any residential or commercial projects. Like all Hammerton fixtures, they are designed and fabricated in Salt Lake City, Utah using domestically sourced materials.

POWERFUL DESIGN

Since 1992, Hammerton has been known for extraordinary decorative lighting that is boldly designed, expertly rendered, perfectly proportioned and exquisitely detailed. Each fixture exudes a design aesthetic that is timeless and enduring, yet remarkably relevant.

UNCOMPROMISING CRAFTSMANSHIP

In addition to their exceptional metalworking and finishing expertise, Hammerton artisans share an aesthetic eye and a sculptural talent that define the difference between ordinary and extraordinary craftsmanship. Every fixture demonstrates its artisan's ability to elevate craft to an art form.

UNIQUE MATERIALS

Hammerton's recent acquisition of the Lightspann brand has added unparalleled strength in all types of artisan glass, including hand-blown, slumped, fused, and lampworked glass. The combination of Hammerton's traditional metalworking and Lightspann glass allows steel, woven mesh, fabric and glass to be combined in a manner which cannot be duplicated

A REPUTATION REFLECTED BY OUR CLIENTS

Hammerton fixtures are as extraordinary as the clients who purchase them, including Forbes 400 members, Fortune 500 leaders, award-winning entertainers, fashion and interior designers, sports legends, and leading luxury hospitality brands.

Hammerton
217 Wright Brothers Drive
Salt Lake City, UT
84116

801-973-8095
info@hammerton.com
www.hammerton.com

Warranty

ONE YEAR LIMITED WARRANTY

Hammerton, Inc. (Hammerton) warrants the original owner that this product will be free of defects in material or workmanship for the period of one year from the date of original purchase from Hammerton, if (i) the allegedly defective product has not been abused, misused or improperly maintained and or repaired during the warranty period, (ii) the defect is not caused by water damage/flooding, fire, explosion, earthquakes or similar phenomenon, and (iii) the defect is not caused by improper installation (unless installed by Hammerton). In order to obtain warranty service, the user must first complete a warranty claims form. Hammerton will determine if the product will be inspected on site or returned to Hammerton. If after the inspection Hammerton finds that the product is defective as claimed, Hammerton will, at its option, repair or replace the product free of charge, or Hammerton may in its sole discretion, refund the purchase price. Hammerton warrants any replaced or repaired products for ninety days after shipment or through the end of the original warranty period, whichever is longer. All products or parts that are replaced become the property of Hammerton. No representative or employee of Hammerton is authorized to make any modification or addition to this limited warranty.

TO THE FULL EXTENT ALLOWED BY LAW, THE FOREGOING WARRANTY AND REMEDIES ARE EXCLUSIVE, AND HAMMERTON EXPRESSLY DISCLAIMS ALL OTHER WARRANTIES, EXPRESSED OR IMPLIED, INCLUDING WITHOUT LIMITATION THE IMPLIED WARRANTIES OF MERCHANTABILITY AND FITNESS FOR A PARTICULAR PURPOSE. TO THE FULL EXTENT ALLOWED BY LAW, HAMMERTON EXCLUDES AND DISCLAIMS LIABILITY, WHETHER BASED IN CONTRACT OR TORT (INCLUDING NEGLIGENCE FOR ANY CONSEQUENTIAL, INDIRECT INCIDENTAL OR SPECIAL DAMAGES OF ANY NATURE ARISING OUT OF THE SALE INSTALLATION, MAINTENANCE, USE OR FAILURE OF THIS PRODUCT, EVEN IF HAMMERTON HAS BEEN ADVISED OF THE POSSIBILITY OF SUCH DAMAGES IN ADVANCE, AND HAMMERTON LIMITS ITS LIABILITY TO REPLACEMENT, REPAIR OR REFUND OF THE PURCHASE PRICE PAID, AT HAMMERTON'S OPTION.) SOME STATES DO NOT ALLOW LIMITATIONS ON HOW LONG AN IMPLIED WARRANTY LASTS AND/OR DO NOT ALLOW THE EXCLUSION OR LIMITATION OF INCIDENTAL OR CONSEQUENTIAL DAMAGES, SO THE ABOVE LIMITATION ON IMPLIED WARRANTY AND INCIDENTAL OR CONSEQUENTIAL DAMAGES MAY NOT APPLY TO YOU. THIS WARRANTY GIVES YOU SPECIFIC LEGAL RIGHTS YOU MAY HAVE OTHER RIGHTS, WHICH VARY FROM STATE TO STATE

HAMMERTONSTUDIO®

Mounting Instructions

Packet X

WARNING: FAILURE TO INSTALL THIS FIXTURE PROPERLY MAY RESULT IN SERIOUS PERSONAL INJURY OR DEATH AND PROPERTY DAMAGE.

It is recommended that this product be installed by a licensed electrician.

Included Components

- A. Universal (1)
- B. 1.5" long, #8-32 pan head screws (4)
- C. E-Z Toggle™ Kit
 - i. E-Z Toggle™ (2)
 - ii. 2" coarse thread Phillips pan head (2)
- D. Washers (2)
- E. Wire nuts (3) (not shown)

Required Tools

- 1. Phillips screw driver (not provided)

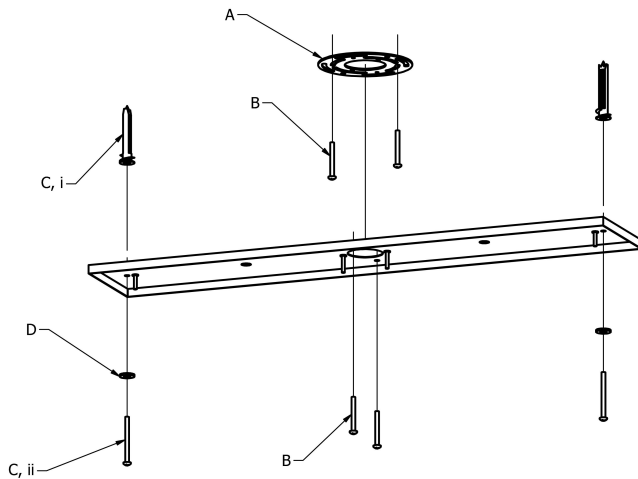

Mounting Instructions

Step 1: If needed, attach universal (A) to the J-box housing in your ceiling using the arced slots and 1.5" long, #8-32 pan

Step 2: Mount the canopy back plate to the universal (A) using the 1.5" long, #8-32 pan head screws (B).

Step 3: If the fixture is to be mounted to drywall secure the outer holes of the canopy back plate using the E-Z Toggle™ fasteners (C) and following the E-Z Toggle™ directions to the right. Use proved washers (D) during step 2 of E-Z Toggle™ instructions. If the fixture is to be mounted to wood, such as a wood beam, use wood screws (not provided) in place of the E-Z Toggles™.

E-Z Toggle™ Instructions

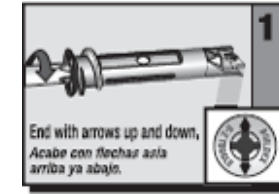

Turn E-Z Toggle into drywall until seated flush. Arrows on head indicate direction toggle clamp will open. End with arrows up and down.

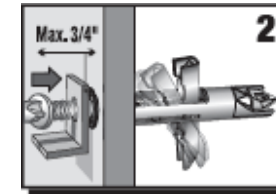

Place fixture over E-Z Toggle. Push screw into E-Z Toggle to engage clamp

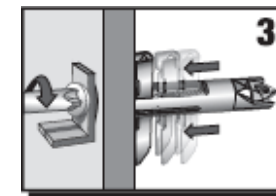

Turn screw until it stops. Toggle clamp tightens against drywall as screw is turned.